

SMART, FLEXIBLE FURNITURE

Educational & Learning Spaces

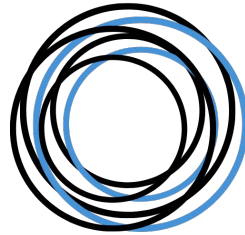

SPACES TAYLORED



Educational Product Guide

08431229545 | www.spacestaylored.com | info@spacestaylored.com

Welcome to the 2021-22 Spaces Taylored Product Guide

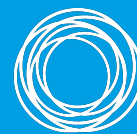

SPACES TAYLORED

Educational & Office Furniture Suppliers

Why Choose Spaces Taylored?

Well, for one, they are an accredited British Educational Supplier! But also.....

Spaces Taylored, supply and install quality furniture for commercial or educational. From Ergonomic Chairs for improved posture and height adjustable desks for sitting or standing to full redesign and refurbishment.

Spaces Taylored can transform any environment into an amazing place to learn or work. We passionately believe your working environment should look great and feel comfortable. Let us help you transform your space into a stylish, functional and comfortable place to learn or work with our free design and space planning service.



It's Easy to Order!

Just contact us and we'll confirm your order and delivery date within 24 hours.



Web:

www.spacestaylored.com



Phone:

08431229545



Email:

info@spacestaylored.com



Alcumus
SafeContractor



**BRITISH EDUCATIONAL
SUPPLIERS ASSOCIATION**



FRIENDLY HELP AND ADVICE

We're here to help answer any questions you may have.

08431229545



New Products Added to our Catalogue!



TriUnion Tables Page 22



Hotbox Desk Organiser Page 363



STEM Learning Storage Page 81



Whiteboard Tables Page 12



Blox Page 202

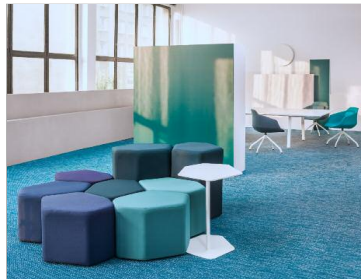

Causeway Stools Page 246

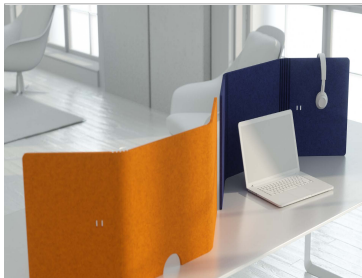

The Hide Page 403



Nook Page 242

Contents

Classroom Furniture	8-47
Classroom Storage	48-98
Early Years	97-129
Cloakrooms & Lockers	130-143
IT Suites	144-158
Dining Furniture	159-181
Libraries & Learning Zones	182-201
Staging & Auditorium Seating	202-211
Seating	213-282
Receptions	283-296
Office furniture & Janitorial	297-365
Presentation & Display	366-398
Acoustic Surfaces	399-405
Outdoor Furniture	404-419
Design & Refurbishment	420-441
Index	442-447



We want to help you get the right products and the best deals, so please look out for products with these highlights.



See Page 197



See Page 237

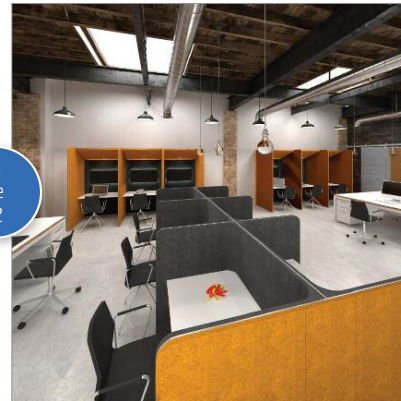

See Page 202

Create a learning hub within your school to encourage pupils to explore different ways of learning and take charge of their own education experience. Excellent for assisting students with different learning styles and also prepares them for lifelong learning.



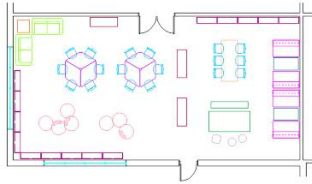

Cluster tables have unlimited possibilities for arranging into different shapes for flexible room layouts

See Page 11

RETHINKING THE CLASSROOM

ARE FLEXIBLE SCHOOL ENVIRONMENTS THE FUTURE OF EDUCATION?

Latest research shows that activity based furniture will enable the best education experience.

See Page 28



See Page 243



See Page 242



Design & Installation Service

*Innovative ideas & designs
with reading & learning at
the heart.*



*Get a design from our
experienced design team.*



Planning to create a new Library Space?

Looking for inspiration and new ideas?

Want to know exactly how a new design will look?

Talk to us today about our design & installation service to transform your Library and School.

SENSORY



Planning to create a new Sensory room or supported Learning Hub?

Looking for inspiration and new ideas?

We have a separate Sensory & Educational Resource catalogue, contact us to have a copy sent out or to discuss your requirements further.



See Page 242

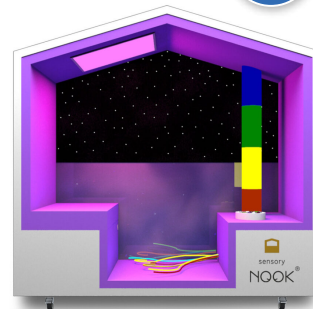





Classroom Furniture

Calypso	11	Poly Chairs	32-33
Premium Senior Tables	12	The Profile Chair Active	34
Whiteboard Tops	12	Balance Stool Opto	35
Fully Welded Tables	15-16	Flow Chair	36
Crushed Bent Tables	17-18	Chevron Chair Positive	37
Work Benches	22-23	Posture	38
Height Adjustable Desks	24	ERgo Chair	38
Teacher's Desks Furniture	25-26	Pennine Posture Chair	39
Class packs	27	Folding Chairs & Trolleys	40
Study Booths	28	Stools & High Chairs	41-44
Jollyback Chairs	29	Exam Desks & Chairs	45-46
Planet Chair	31		
Chiltern Chair	31		

[Main Content Page](#)

Classroom Furniture

Ordering school furniture can be a daunting task, especially when spending so much of your school budget. If you are kitting out a new classroom or replacing a number of tables and chairs then simply selecting from a catalogue may not be the best option.

We can advise on the best table and chair heights, surfaces and edge options and the best classroom layouts for your needs. We have years of experience and will take all your needs into account - your budget, the age of the pupils, and the type of uses and environment that the furniture will be used in. Whether it is DT benches and stools, IT

seating, or standard classroom furniture you require, we will be happy to advise on health and safety considerations, British Standards, lighting and ergonomics.

There is no obligation to buy from us, but we would welcome the opportunity to provide you with a quote and to prepare layout drawings for you to consider.

We have the expertise to protect you from potentially costly mistakes, so please call us today to discuss your requirements.

- Please could you help us by ordering classroom furniture required for the start of the Autumn term as soon as possible, ideally by May or early June.
- Please advise us of your school opening times during the summer holiday.
- Please include a site contact & phone number
- Please ensure all details are included on your order to avoid delays in starting production
- Please check our order confirmation carefully, as classroom furniture is made to order
- Please do not dispose of your old furniture until the new arrives!

Deliveries for the start of the Autumn term - Order in May to avoid delay!

Choosing Your Tables

3 Table Styles
Crushbent frame - the best option if the tables need to be stacked frequently, the tables can be slide stacked easily.



Fully welded frame - the most popular choice, strong and durable, the tables will stack in a spiral fashion.



Premium frame - Round leg frame gives an extremely strong and modern, attractive look to the classroom, can be spiral stacked.



3 Edge Styles
MDF edge - Lacquered natural wood edge gives a low cost tamperproof solution.

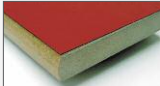

PVC edge - Introduce colour by having a matching or contrasting edge in a wide range of colours, impact resistant.



PU (polyurethane) edge - The ultimate choice, spray applied polyurethane gives a seamless, water resistant, textured durable edge to the table.

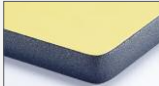

3 Top Styles
Standard Laminate



10 Colours

Premium Laminate



9 Colours

Dry Wipe Laminate



See page 13

Table & Chair Heights

Choosing Tables and Chairs Recommended BS EN1729 heights

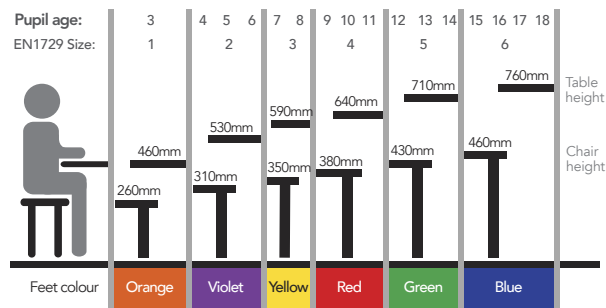

Accepts drywipe pens

Not sure? Please ask for a sample chair or for a consultant to call & check your heights.

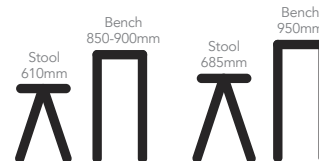



These tables have slimline 32mm legs allowing more spacing for chairs.
Note: premium colours incur a 10% extra charge on this range.



5 Year Warranty



Square

Trapezoidal

Arc



Semi Circular

Rectangle

Circular

PU Edge colours:



PU1 PU2 PU3 PU4 PU5

Frame colours

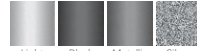

F1 F2

Frame colours: textured silver grey, light grey, metallic charcoal or black. Silver grey will be supplied unless otherwise stated

Top Colours Standard



Red Green Blue Yellow Beech Maple Oak Lt Grey Ailsa Speckle White Dry Wipe

T1 T2 T3 T4 T5 T6 T7 T8 T9 T10 W1

Calypso Heavy Duty Furniture

Some educational environments demand furniture that will withstand greater wear and tear, these products are manufactured to last and last together with eye-catching style

Heavy duty tables

- 32mm welded tubular frame
- 18mm thick top with a balancing laminate and PU textured edge
- Tamperproof screws
- Choice of laminate colours and Trespa Tops (POA)
- Heavy duty castors can be fitted on 2 legs for mobility at additional cost
- 710mm height as standard, other heights available to order
- Frame colours: DURAFORM scratch resistant textured silver grey, light grey, metallic charcoal or black. Silver grey will be supplied unless otherwise stated
- Orders of less than 5 tables may carry a delivery charge

Textured PU Edge, standard laminate

Y16435	1200 x 600mm Rectangular	POA
Y16438	600 x 600mm Square	POA
Y16441	1200mm Trapezoidal	POA
Y16444	1200mm Semi Circular	POA
Y16447	1200mm Circular	POA
Y15602A	1490 x 600mm Arc	POA
Y16449	Set of Heavy Duty Castors (2)	POA



Quantity rates available

Premium senior range



- Highest quality fully welded tables with stylish, chunky 32mm tubular legs
- Standard 18mm tops in MDF Bullnose edge with a hard wearing laminate - polished and laquered
- Also available with Duraform spray PU edge - POA
- Also available in 16mm Trespa top - which is a solid grade material with a black core and crystal matt surface texture, with smooth and sealed edges. It is particularly suitable for laboratory and food preparation areas. (POA)
- Exceptional strength and style vastly superior to bolt-on and screw on leg systems
- Orders of less than 3 tables may carry a delivery charge
- Colours as shown on page 12
- Also available in primary heights

Square

Y15783	600 x 600 x H710mm	POA
Y15784A	600 x 600 x H760mm	POA

Rectangular

Y15789	1200 x 600 x H710mm	POA
Y15790A	1200 x 600 x H760mm	POA

Semi Circle

Y15792A	1200 Semi Circle H710mm	POA
Y15793	1200 Semi Circle H760mm	POA



See page 11 for colour options



5 Year Warranty



Fully welded leg frames - not screwed or bolted

Whiteboard drywipe tables

Drywipe whiteboard tops are available on all sizes of tables - please contact us for details.

Whiteboard tops (additional cost)

Y100902	£12.59
---------	--------



Quantity rates available

SquibbleTop



INTERACTIVE WRITABLE SCHOOL DESKS

SquibbleTop was created for the educational sector, and designed to assist pupil creativity and collaboration in the classroom.

Our new product links in with the current national curriculum and is an excellent accompaniment to early years learning. The bespoke design, which incorporates school logo's/ branding etc, allows pupils to advance learning outcomes by writing directly onto the desk and can be adapted to function in any other learning environment or for any age group.

The template design is specific to the school and/or the user age group. For pupils in pre-school/nursery classes the key emphasis is about colour, shapes, name/ letter recognition, drawing and creativity. In Primary classes - P1 to P3 - the curriculum emphasis moves to number and letter recognition, sentence construction, simple mathematics, handwriting, drawing, basic problem solving and task completion.

Our designs allow for all these tasks to be completed by writing on the desk top.



Teachers can photograph the completed work and send it to the pupils account in 'the cloud'. Parents are then shown the examples during parent's events and school visits. To learn more visit us at smarterconcepts.co.uk

To-Do Lists

Designed and branded to your requirements, our writable, erasable 'to do list' are the perfect accomplement for any desk or workstation. These are purchased in packs of 20.



Best Seller

5 Year Warranty



Classroom Tables - Fully Welded

- These welded frame tables are proven in the education market and have passed FIRA tests for severe educational use
- The welded frame means the tables can only be spiral stacked 4 to 5 high, as opposed to crushbent tables that can be slide stacked. However, the welded frames tend to be stronger
- This fast selling, popular product has a hard wearing laminate top with MDF core
- Frame colours: black, light grey, silver grey or metallic charcoal (other frame colours available as specials POA), black will be supplied unless specified
- Choice of rounded MDF edge or square PVC edge, a rounded PVC edge is also available POA
- Orders of less than 5 tables may incur a carriage charge

Fully EN1729 Compliant

Express Delivery on Items Marked*

*Outside summer period

A



B



C



Quantity rates available

A. 1200 x 600mm rectangular

- Welded Frame

Rounded MDF Edge

Y15790	H460mm	POA
Y15794	H530mm	POA
Y15798	H590mm	POA
Y15802W*	H640mm	POA
Y15806*	H710mm	POA
Y15810*	H760mm	POA

Square PVC Edge

		30+
Y15792	H460mm	POA
Y15796	H530mm	POA
Y15800	H590mm	POA
Y15804	H640mm	POA
Y15808	H710mm	POA
Y15812	H760mm	POA

B. 1100 x 550mm rectangular

- Welded Frame

Rounded MDF Edge

		30+
Y15822	H460mm	POA
Y15826	H530mm	POA
Y15830	H590mm	POA
Y15834	H640mm	POA
Y15838	H710mm	POA
Y15842	H760mm	POA

Square PVC Edge

		30+
Y15824	H460mm	POA
Y15828	H530mm	POA
Y15832	H590mm	POA
Y15836	H640mm	POA
Y15840	H710mm	POA
Y15844	H760mm	POA

C. 1100 x 550mm trapezoidal

- Welded Frame
- Also available in 1200 x 600mm POA

Rounded MDF Edge

		30+
Y15846	H460mm	POA
Y15850	H530mm	POA
Y15854	H590mm	POA
Y15858	H640mm	POA
Y15862	H710mm	POA
Y15866	H760mm	POA

Square PVC Edge

		30+
Y15848	H460mm	POA
Y15852	H530mm	POA
Y15856	H590mm	POA
Y15860	H640mm	POA
Y15864	H710mm	POA
Y15868	H760mm	POA

Also available in 1200 x 600mm POA

Delivery

All classroom tables and chairs are delivered fully assembled.

Delivery approximately 4 weeks although this will extend over the summer ordering period.

We recommend you do not dispose of your old furniture until you have taken delivery of your new.

Classroom Furniture

Classroom Tables



A. 600 x 600mm square

- Welded Frame
- Also available in 550 x 550mm POA

Rounded MDF Edge

Y15870	H460mm	POA
Y15874	H530mm	POA
Y15878	H590mm	POA
Y15882	H640mm	POA
Y15886*	H710mm	POA
Y15890*	H760mm	POA

Square PVC Edge

Y15872	H460mm	POA
Y15876	H530mm	POA
Y15880	H590mm	POA
Y15884	H640mm	POA
Y15888	H710mm	POA
Y15892	H760mm	POA

B. 1000mm diameter circular

- Welded Frame
- Also available in 750, 800 and 1100mm diameters POA

Rounded MDF Edge

Y15894	H460mm	POA
Y15898	H530mm	POA
Y15902	H590mm	POA
Y15906	H640mm	POA
Y15910	H710mm	POA
Y15914	H760mm	POA

Square PVC Edge

Y15896	H460mm	POA
Y15900	H530mm	POA
Y15904	H590mm	POA
Y15908	H640mm	POA
Y15912	H710mm	POA
Y15916	H760mm	POA

C. 1200 x 600mm diameter semi-circular

- Welded Frame
- Rounded MDF Edge

Y15918	H460mm	POA
Y15922	H530mm	POA
Y15926	H590mm	POA
Y15930	H640mm	POA
Y15934	H710mm	POA
Y15938	H760mm	POA

Square PVC Edge

Y15920	H460mm	POA
Y15924	H530mm	POA
Y15928	H590mm	POA
Y15932	H640mm	POA
Y15936	H710mm	POA
Y15940	H760mm	POA

D. 1100 x 550mm diameter semi-circular

- Welded Frame
- Rounded MDF Edge

Y15942	H460mm	POA
Y15946	H530mm	POA
Y15950	H590mm	POA
Y15954	H640mm	POA
Y15958	H710mm	POA
Y15962	H760mm	POA

Square PVC Edge

Y15944	H460mm	POA
Y15948	H530mm	POA
Y15952	H590mm	POA
Y15956	H640mm	POA
Y15960	H710mm	POA
Y15964	H760mm	POA

Top Colours Standard

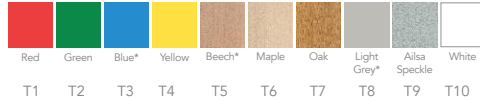

* Available on express delivery outside summer holiday period

PVC Edge Colours



Edge Options

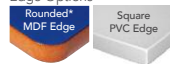

Frame colours

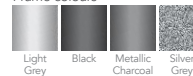

Primary coloured frames also available. Please ask for details.

F1

*Please add colour choice onto the code when ordering *

Express Delivery on Items Marked*
*Outside summer period



A



B



C



D

Quantity rates available

Best Seller



Classroom Tables - Crushbent Frame

- The following range of crushbent framed tables is one of the largest in the UK
- All our products have been proved suitable for severe educational use
- This fast selling table is very popular as it can be easily stacked due to the frame design
- The top has a MDF core with a hard wearing laminate finish
- Frame colours: black, light grey or metallic charcoal (other frame colours available as specials POA), black will be supplied unless specified
- Choice of rounded MDF or square PVC edge, a rounded PVC edge is also available POA
- Orders of less than 5 tables may incur a carriage charge

A



MDF edge

A. 1200 x 600mm rectangular

- Crushbent frame for easier stacking

Rounded MDF Edge

Y15686	H460mm	POA
Y15690	H530mm	POA
Y15694	H590mm	POA
Y15698	H640mm	POA
Y15702	H710mm	POA
Y15706	H760mm	POA

Square PVC Edge

Y15688	H460mm	POA
Y15692	H530mm	POA
Y15696	H590mm	POA
Y15700	H640mm	POA
Y15704	H710mm	POA
Y15708	H760mm	POA

5 Year Warranty

On All These Products

Express Delivery on Items Marked*

*Outside summer period

B



Quantity rates available

Slide Stacking

B. 1100 x 550mm rectangular

- Crushbent for easier stacking

Rounded MDF Edge

Y15718	H460mm	POA
Y15722	H530mm	POA
Y15726	H590mm	POA
Y15730*	H640mm	POA
Y15734*	H710mm	POA
Y15738T*	H760mm	POA

Square PVC Edge

Y15720	H460mm	POA
Y15724	H530mm	POA
Y15728T	H590mm	POA
Y15732	H640mm	POA
Y15736	H710mm	POA
Y15740	H760mm	POA

*Please add colour choice onto the code when ordering *

Top Colours Standard

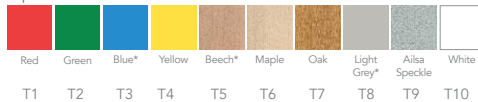

PVC Edge Colours



Edge Options

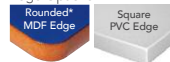

*Please add colour choice onto the code when ordering *

Frame colours



Primary coloured frames also available. Please ask for details.

**5 Year
Warranty**
On All These
Products

**Express
Delivery on
Items
Marked***
*Outside
summer period

**Fully
EN1729
Compliant**

Delivery

All classroom tables and chairs are delivered fully assembled. Delivery approximately 4 weeks although this will extend over the summer ordering period. We recommend you do not dispose of your old furniture until you have taken delivery of your new.

A



Spray PU Edge

B



C



Also available in
1200 x 600mm POA

D



**Quantity
rates
available**

PU Edged Tables



- Impact Resistant - Waterproof Edge Guarantee
- This new technology in table manufacturing is extremely popular as the textured coloured edging is moulded onto the edge of the table, meaning that it cannot be prised or picked away
- Give your classroom an unfading, long lasting, colourful feel with these bright, cheerful and popular classroom tables
- Available with crushbent (stacking) or fully welded frames
- Frame colours: black, light grey or metallic charcoal (other frame colours available as specials POA), black will be supplied unless specified
- Orders of less than 5 tables may incur a carriage charge

A. 1200 x 600mm rectangular

- Crushbent frame

PU Edged

Y15496	H460mm	POA
Y15498	H530mm	POA
Y15500	H590mm	POA
Y15502*	H640mm	POA
Y15504*	H710mm	POA
Y15506*	H760mm	POA

B. 1100 x 550mm rectangular

- Crushbent frame

PU Edged

Y15507	H460mm	POA
Y15508	H530mm	POA
Y15510	H590mm	POA
Y15512*	H640mm	POA
Y15514*	H710mm	POA
Y15516*	H760mm	POA

C. 1100 x 550mm trapezoidal

- Crushbent frame

PU Edged

Y15530	H460mm	POA
Y15532	H530mm	POA
Y15534	H590mm	POA
Y15536	H640mm	POA
Y15538	H710mm	POA
Y15540	H760mm	POA

D. 600 x 600mm square

- Crushbent frame

PU Edged

Y15518	H460mm	POA
Y15520	H530mm	POA
Y15522	H590mm	POA
Y15524	H640mm	POA
Y15526*	H710mm	POA
Y15528*	H760mm	POA

*Please add colour choice onto the code when ordering *

Classroom Furniture

A. 1200 x 600mm rectangular

- Welded frame

PU Edged

Y15554	H460mm	POA
Y15556	H530mm	POA
Y15558	H590mm	POA
Y15560*	H640mm	POA
Y15562*	H710mm	POA
Y15564*	H760mm	POA

B. 1100 x 550mm rectangular

- Welded frame

PU Edged

Y15566	H460mm	POA
Y15568	H530mm	POA
Y15570	H590mm	POA
Y15572*	H640mm	POA
Y15574*	H710mm	POA
Y15576*	H760mm	POA

C. 600 x 600mm square

- Welded frame

PU Edged

Y15578	H460mm	POA
Y15580	H530mm	POA
Y15582	H590mm	POA
Y15584	H640mm	POA
Y15586*	H710mm	POA
Y15588*	H760mm	POA

D. 1100 x 550mm trapezoidal

- Welded frame

PU Edged

Y15590	H460mm	POA
Y15592	H530mm	POA
Y15594	H590mm	POA
Y15596	H640mm	POA
Y15598	H710mm	POA
Y15600	H760mm	POA

E. 1000mm diameter circular

- Welded frame

PU Edged

Y15602	H460mm	POA
Y15604A	H530mm	POA
Y15606A	H590mm	POA
Y15608A	H640mm	POA
Y15610A	H710mm	POA
Y15612	H760mm	POA

Top Colours Standard

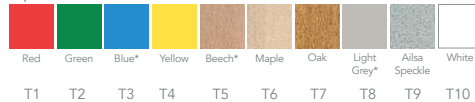

* Available on express delivery outside summer holiday period

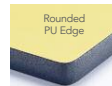

A



B



C



D



E

Also available in 1200 x 600mm POA

Frame colours



F1

Please ask for details.

PU Edge colours:

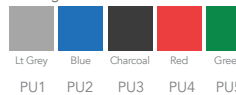

5 Year
Warranty

On All These
Products

Express
Delivery on
Items
Marked*

*Outside
summer period

Gloss White 'Dry Wipe'
option at extra cost on
standard tables

Order code:
Y100102 £10.95



5 Year Warranty

Tray Tables



- Provide some individual storage for the students with these standard classroom tables with special tray packs fitted
- The tables will take all standard trays and some very attractive colour schemes can be worked in the classrooms through use of the trays and table tops
- Frame colours: black, light grey, silver grey or metallic charcoal (other frame colours available as specials POA), black will be supplied unless specified
- Please check that pupils will have sufficient leg room under tray tables; you may wish to move up a size
- Orders of less than 5 tables may incur a carriage charge

Quantity rates available

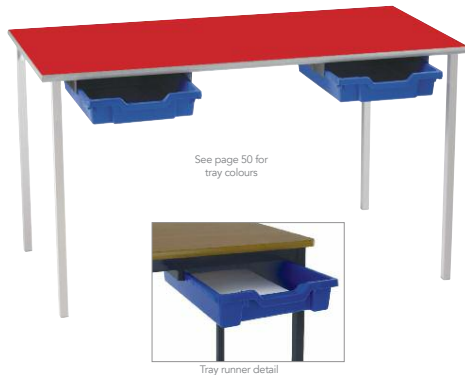

A. 1200 x 600mm rectangular

- Welded frame tables

MDF Edge

Y15614A	H460mm	POA
Y15618A	H530mm	POA
Y15622A	H590mm	POA
Y15626A	H640mm	POA
Y15630A	H710mm	POA
Y15634A	H760mm	POA

Square PVC Edge

Y15616	H460mm	POA
Y15620A	H530mm	POA
Y15624A	H590mm	POA
Y15628A	H640mm	POA
Y15632A	H710mm	POA
Y15636A	H760mm	POA

Tray tables can also be supplied with a Polyurethane edge instead of PVC- ring for details

Edge Options



PVC Edge Colours



PU1 PU2 PU4 PU5 PU6 PU7

Frame colours

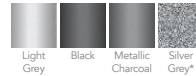

F1

F2

Primary coloured frames also available. Please ask for details.

Top Colours Standard

* Available on express delivery outside summer holiday period



T1 T2 T3 T4 T5 T6 T7 T8 T9 T10

Classroom Furniture

A. 1100 x 550mm rectangular

- Welded frame tables • Double tray

5 Year
Warranty

MDF Edge

Y15638A	H460mm	POA
Y15642	H530mm	POA
Y15646	H590mm	POA
Y15650	H640mm	POA
Y15654B	H710mm	POA
Y15658A	H760mm	POA

Square PVC Edge

Y15640	H460mm	POA
Y15644	H530mm	POA
Y15648	H590mm	POA
Y15652A	H640mm	POA
Y15656A	H710mm	POA
Y15660	H760mm	POA



B. 600 x 600mm square

- Welded frame tables • Single tray

MDF Edge

Y15662	H460mm	POA
Y15666	H530mm	POA
Y15670	H590mm	POA
Y15674	H640mm	POA
Y15678	H710mm	POA
Y15682	H760mm	POA

Square PVC Edge

Y15664	H460mm	POA
Y15668	H530mm	POA
Y15672	H590mm	POA
Y15676	H640mm	POA
Y15680	H710mm	POA
Y15684	H760mm	POA



Tray tables can also be supplied with a Polyurethane edge instead of PVC- ring for details

*Please add colour choice onto the code when ordering *

Please specify:

1. frame colour
2. top colour
3. edge colour (if PVC)
4. tray colour (see page 50, stock colours only)

Top Colours Standard

* Available on express delivery outside summer holiday period

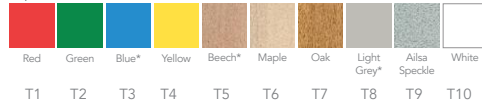

Edge Options

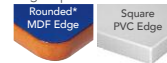

Quantity
rates
available

PVC Edge Colours



Frame colours

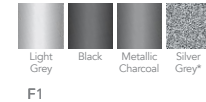

A

Express Delivery



Craft Tables



A. Project table

- Sturdy tables for all types of projects
- Light grey laminated tops for durability
- All 800mm high for ease of use
- Frame colours: Grey, Apple Green, Cool Blue, Cyan, Lime, Red & Tangerine

Y15986	W1200 x D1200mm	POA
Y15988	W1800 x D1200mm	POA
Y15990	W2400 x D1200mm	POA

B



B. TriUnion tables



- Highly flexible
- enables multiple learning situations
- Heights available are 88, 106, 120mm
- Modular
- Plastic edge or HPL edge
- Optional table connectors

Laminate Top

Y15604	1163mm x 117mm x 177mm x h88mm	POA
Y15605	163mm x 117mm x 177mm x h06mm	POA
Y15606	163mm x 117mm x 177mm x h20mm	POA

Orders of less than 30 chairs may carry a carriage charge

Contact for more info



C

10 Year Warranty

Quantity rates available



C. Premium 'H' frame craft table

- Extremely strong H frame table, round heavy duty 45mm frame
- Laminate or Trespa tops available
- Heights available are 760, 800, 850, 900, 1000mm
- MDF edge, PU also available POA

Laminate top

YPREM126LAM	1200mm x 600mm	POA
YPREM127LAM	1200mm x 750mm	POA
YPREM157LAM	1500mm x 750mm	POA

Trespa top

YPREM126TRES	1200mm x 600mm	POA
YPREM127TRES	1200mm x 750mm	POA
YPREM157TRES	1500mm x 750mm	POA

Please specify required height

Other colours available. For critical colour matching please ask for a sample

Top Colours - Laminate



T5 T7 T8 T9 T10

Frame colours

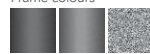

F2 F3 F4

Trespa Speckled Top Colours



TR1 TR2 TR3 TR4

Page Link - see pages

For stools...

41-44



Maker Space Benches



A. Heavy duty steel frame workbench suitable for woodwork and metalwork

- 1200 x 1200mm choice of 810 or 860mm height
- Available with or without cupboards
- Choice of tops (phenolic available for metalworking - POA)
- Choice of frame colours
- Choice of flip over tool well (as illustrated) or solid beech flush tops
- Orders of less than 5 benches may incur a carriage charge

Solid Beech Top

155011	Workbench with Cupboard	POA
155012	Workbench without Cupboard	POA

MDF Top with Solid Beech Edgings

155013	Workbench with Cupboard	POA
155014	Workbench without Cupboard	POA

Vice for Benches

155015	175mm Plain Screw Woodwork Vice	POA
--------	---------------------------------	-----

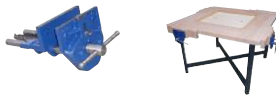

Frame Colours



Red Green Blue Yellow Black Anthracite Grey Light Grey

F9 F10 F7 F8 F2 F

B. Multipurpose technology bench



- 1200 x 1200 x 860mm height (other heights available)
- Choice of frame colours
- Choice of tops
- Orders of less than 5 benches may incur a carriage charge

155018	Bench with MDF Top	POA
155019	Bench with Zinctec Metal Top	POA
155020	Heavy Duty Castors for Bench set of 4	POA



Quantity rates available

Bespoke Work Benches And Tables Available- Please Ask For Details Quantity Discounts Available



Can be accessed from either side



Glides supplied as standard with optional Castors at a further cost. Table frame available in Silver only.



Fold-in crank arm available



Access height adjustable table



- Modern silver frame, strong construction
- Infinitely adjustable by handle between 512 and 805mm
- Suitable for wheelchair use
- MDF or PU edge (POA)
- Available with Trespa tops for science or food tech use - poa

1200 x 600mm Double Desk

Y15802 Access Desk - MDF Edge POA

750 x 600mm Single Desk

Y15803 Access Desk - MDF Edge POA

Heavy Duty Top 25mm

Y16727 Additional Cost POA

A full range of other sizes are available

Quantity rates available

Top Colours Standard

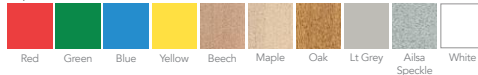

T1 T2 T3 T4 T5 T6 T7 T8 T9 T10

PU Edge colours. Additional cost

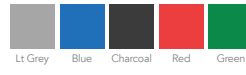

PU1 PU2 PU3 PU4 PU5

Edge Options



MDF Edge PU Edge (addnl cost POA)

Express Delivery
7 Year Warranty

A



Express Delivery
5 Year Warranty

B



Frame colours

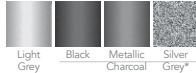

C

Quantity rates available



Please specify:
1. frame colour
2. top colour
3. edge colour (if PVC or PU)

Top Colours Standard

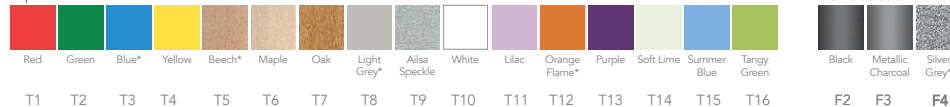

Teacher's Desks



A. Single pedestal desk

- This popular range of teacher's desks is available in a choice of wood finishes
- Drawers are mounted with metal runners and are fully lockable
- 3 drawer on right side supplied as standard, a 2 drawer pedestal including a filing drawer is also available at the same cost. Pedestals can be fitted on either side, please specify
- 5 year guarantee
- Quantity discounts available

Y15490 1200 x 745 x 725mm High POA

Y15492 1500 x 745 x 725mm High POA

Please specify melamine wood finish as shown below

B. Double pedestal desk

- The double pedestal desk is a long-standing favourite with teachers, providing extra storage and a filing drawer
- Drawers are mounted with metal runners and are lockable
- 5 year guarantee
- Quantity discounts available

Y15494 1500 x 745 x 725mm High POA

Please specify melamine wood finish as shown below

Page Link - see page

For teacher's chairs



Page Link - see page

For teacher's cupboards



C. Teacher's desk

- Teacher's desk to match student desks on pages 14-19
- MDF edge (PVC and PU edges available at extra cost)
- Fully welded frame, delivered assembled

Y100201 2 Drawer Teacher's Desk POA

Please specify melamine wood finish as shown below

*Please add colour choice onto the code when ordering *

Teacher's Desks



A. Alpine panel leg teacher's desk

- 25mm thick MFC top with 3mm abs edging
- Choice of 6 colours
- Locking drawers
- Complete with 2 cable ports
- 5 year warranty
- Matches Alpine furniture on page 310

Y100100	Single Pedestal Desk 1200 x 800 x H725mm	POA
Y100101	Double Pedestal Desk 1600 x 800 x H725mm	POA

Alpine Tables MFC Finishes

Group 1 Colours



Beech Amber Oak White Oak White Pearl Grey

Group 2 Colours +10%



Grey Nordic Wood Sand Ash Cubanite Grey Tobacco Walnut

W4 W2/3 W2/4 W6 W9

W11 W12

Wood & colour finishes may not be representative of actual colours - please ask for a sample

*Please add colour choice onto the code when ordering *

Express Delivery

5 Year Warranty



A

B. Colorado compact desk

- Compact teacher's desk with lockable 3 drawer pedestal
- 1200 x 600mm
- 12 finishes are available
- Complete with 2 cable ports
- 5 year warranty

Y100103	Colorado Compact Desk	POA
---------	-----------------------	-----

Wood Finish Options



Walnut Verade Oak Autumn Cherry Beech Ash White Nebraska Oak

W1 W2 W3 W5



Barley Bureau Oak Maple Grey Anthra-cite Concrete Grey Cedar

W7 W2/2 W8 W9 W10 W11 W12

Express Delivery

5 Year Warranty



B

Page Link - see page

For teachers' cabinets

400



Page Link - see page

More teachers' desks...

301-303

Quantity rates available

Save \$\$\$ with our 'ready to go' class packs

Furniture Class Packs

Silver Class Pack

Y100205 POA

Pack Includes:

15 Classroom rectangular tables, MDF edge, any size or colour from pages 15-17.

30 Poly chairs, any size or colour from page 30 (excluding skid base chairs).



Gold Class Pack

Y100206 POA

Pack Includes:

16 Classroom rectangular tables, PU edge, any size or colour from pages 17-19.

32 Mono Postura chairs, any size or colour from page 38.

1 Teacher's desk Y100100 or Y100202 from pages 25, any colour.

1 Teacher's chair: Merlin Y20110 with arms, upholstered in any Advantage, Era or Phoenix fabric.



Bespoke class pack? Let us design one to your requirements.

Study booths

- Simple, cost-effective way to give privacy for the pupil who needs to concentrate
- Desktops are 800mm wide x 600mm deep with the side panels 1200mm high
- 18mm thick panels with ABS edging
- Bespoke versions for inclusion rooms also available



Triple Single Sided



Double Single Sided



Single Sided



Pinboards and CPU holder are optional extras



A. Single sided

- W836 x D645 x H1200mm

Y100207

POA



B. Double sided

- W1654 x D645 x H1200mm

Y100208

POA



C. Triple single sided

- W2472 x D645 x H1200mm

Y100209

POA



D. Single sided add-on booth

- W818 x D645 x H1200mm

Y100210

POA



E. Double sided

- W836 x D1268 x H1200mm

Y100211

POA



F. Double double sided

- W1654 x D1268 x H1200mm

Y100212

POA



G. Triple double sided

- W2472 x D1268 x H1200mm

Y100213

POA



H. Double sided add-on booth

- W818 x D1268 x H1200mm

Y100214

POA

I. CPU holder

Y100215

POA

J. Pinboard

Y100216

POA

Standard Colours



Maple W8 Beech W4 T-Beech W4 Verade Oak W2 Portofino Cherry W12 Walnut W1 White W6 Light Grey W9 Dark Grey W9/1 Black W13

*Please add colour choice onto the code when ordering *

Optional Colours (at extra cost)



Blue W14 Red W15 Green W16 Yellow W17 Limette W18 Caribbean Blue W19 Gloss White W6/1 Orange W20 Comina Ash W5/2 Driftwood W21

Quantity rates available



LOCKABLE
CASTORS

Jolly Back Chair

Innovative, low, mobile chair with height adjustable back rest and cushioned wedged seat support. Promotes natural upright posture and reduces awkward bending, twisting and kneeling - all hazardous daily activities of working in early years and primary! Physiotherapist designed.

Large and Medium height chairs are fitted with quality lockable castors for easy, smooth movement when sitting or standing.

Contact us for more info and ordering



NB: The Large Jolly Back chair is in Cobalt with glides. Contact us for pricing and other colours available.



Best Seller

Poly Chairs



A. The PantoSwing chair

- Reverse cantilever leg and under seat padding allows the chair to be safely placed on the desk to allow for easy access to clean under desks
- Ergonomic shape
- Tough and adaptable
- Multiple variant available including ply seat, upholstered, with arms, reverse cantilever leg, 4 leg, castors and draughtsman
- 6 sizes

Seat Height	30+
310mm	POA
350mm	POA
380mm	POA
430mm	POA
460mm	POA
510mm	POA

Orders of less than 30 chairs may carry a carriage charge



Try before you buy!
Sample chairs available



B. Stakki chairs



- Exceptionally space saving
- Indoor and outdoor use
- Red Dot Design winner
- High stacking capability
- Comfortable however you sit
- Matching table available- The Drop

Contact for more information

	Seat Height	Overall Width	
Stakki	460mm	537mm	POA

Orders of less than 30 chairs may carry a carriage charge



Classroom Furniture

A. Planet chair



The Planet chair range is perfect for schools looking for a durable attractive product at an affordable price. The Planet chair features a high quality steel frame and a high grade polypropylene shell and has been tested to EN1729 part 2.

- Frames are finished in a high quality scratch resistant powdercoated black paint
- The products are covered by a six year warranty for peace of mind
- Can be stacked up to 8 units high for storage space efficiency
- 6 year warranty
- Chair manufactured from 99% recycled material
- Orders of less than 10 chairs may carry a carriage charge

		Seat Height	Overall Width	
Y15657	Black	430mm	518mm	POA
Y15658	Blue	430mm	518mm	POA
Y100203	Black	460mm	518mm	POA
Y100204	Blue	460mm	518mm	POA

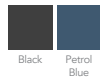

Black Petrol Blue

FROM ONLY £13.50
Ask for a sample chair



A

Quantity rates available

B. Chiltern chair



The Chiltern range represents excellent value for money, a strong classroom chair at a very reasonable price.

- High quality powder coated steel frame
- Stacks 10 high
- 6 year warranty
- Meets EN1729 part 2
- Orders of less than 10 chairs may carry a carriage charge

	Seat Height	Overall Width	
Y100104	260mm	425mm	POA
Y100105	310mm	425mm	POA
Y100106	350mm	425mm	POA
Y100107	380mm	518mm	POA
Y100108	430mm	518mm	POA
Y100109	460mm	518mm	POA
Y100232†	Extra cost for Anti-microbial protection		POA

Shell colours



Leaf Pacific Scarlet Purple

P9 P10 P11 P12

Frame colours



Black Dark Grey Light Grey

F2 F11 F1

*Please add colour choice onto the code when ordering *



6 Year Warranty

B



Antimicrobial

24 Hour Protection

†Available on Blue Only





10 Year Warranty

Express Delivery (Blue Only)

A



Optional Linking Mechanism



Optional Writing Tablet



B

Quantity rates available



Classic Poly Chair



A. Classic poly chair

The original school polypropylene chair design, still one of the most popular.

Tested to EN1729 for strength and stability in addition to general dimensions and seat heights.

- Stacks 6 high
- 10 year warranty

Options available (at extra cost):

- Flame retardancy
- Chair linking (430mm height only)
- Seat upholstery
- Back upholstery
- Writing tablets (chairs with writing tablets will only stack 2 high). Only available on 460mm, 430mm & 380mm high
- Orders of less than 10 chairs may carry a carriage charge

	Seat Height	Overall Width	
Y16701	320mm	350mm	POA
Y16702	350mm	360mm	POA
Y16703	380mm	400mm	POA
Y16704	430mm	470mm	POA
Y16705	460mm	470mm	POA

*Please add colour choice onto the code when ordering *

Frame Colours



Black Grey Silver

F2 F6 F4

Shell Colours



Red Orange Yellow Lime Green Jade Emerald

P1 P13 P4 P14 P2 5 P16



Blue Sapphire Brown Charcoal Black Purple

P3 P17 P18 P5 P7

For critical colour matching please ask for a sample

B. Chair trolley



- Fits most chairs
- Nylon covered wheels

Y16389A Chair Trolley POA

Classroom Furniture

The Poly Superior - Tamperproof

A. The poly superior



- The Poly Superior is one of the most popular brands in the UK
- Ergonomic design with lumbar support
- Extra strong construction with tamperproof fixings
- Heights comply with EN1729 part 1
- Black frame as standard, can also be supplied in light grey, charcoal or silver POA
- Orders of less than 10 chairs may carry a carriage charge

	Seat Height	Overall Width	
Y16350	260mm	410mm	POA
Y16354	310mm	410mm	POA
Y16358	350mm	410mm	POA
Y16362	380mm	480mm	POA
Y16366	430mm	480mm	POA
Y16370	460mm	480mm	POA

For critical colour matching please ask for a sample



P19 P20 P21 P22 P12 P23 P4 P1

*Please add colour choice onto the code when ordering *



Stacks 15 High



Strong sub frame with four anti-tamper rivet fixings.

Quantity rates available

B. Standfast poly chair



- Comfortable and durable traditional poly chair
- Space saving design-narrower than most poly chairs
- Ideal for school hall use where space must be maximised
- Stackable 8 high
- Options- seat and back pads, writing tablets, skid frames version, IT version, please contact us for details
- 10 year warranty, complies with EN1729
- Orders of less than 10 chairs may incur a carriage charge

Code	Seat height	Overall width	
Y100150	260	365	POA
Y100152	310	365	POA
Y100154	350	365	POA
Y100156	380	400	POA
Y100158	430	450	POA
Y100160	460	450	POA

Shell colours



*P3 P24 P7 P18 P1 P2 F13

Please add colour choice onto the code when ordering *

10 Year Warranty

Narrow Width



Please ask for details of other options - Skid Base, Tablet, Upholstered and linking options.

A. The Profile chair



- Modern contoured style
- Meets EN1729 Parts 1 & 2
- Can be stacked 8 high with great stability
- Orders of less than 10 chairs may carry a carriage charge

6 Year
Warranty

Code	Details	Seat Height	Width	
Y100186	4 Legged Chair	430	480	POA
Y100187	4 Legged Chair	460	480	POA
Y100188	Skid Base Chair	430	530	POA
Y100189	Skid Base Chair	460	530	POA
Y100190	Cantilever Chair	430	530	POA
Y100191	Cantilever Chair	460	530	POA
Y100192	Optional Seat Pad			POA

Quantity
rates
available



Strong Riveted Fixings

Frame colours

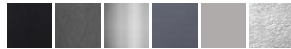

F2 F3 F4 F11 F1 F14

Shell colours:



P24 P14 P12 P3 P7 P1 P24 P25 P26 P4



Mobile chairs - please ask for details

Page Link - see page
For the
IT Swivel
version... 150





New Product 15 Year Warranty

Multipurpose Seating

A. Active balance stool

- Supports movement to assist cognitive development
- Non-slip weighted base
- Lightweight and robust
- 15 year warranty



	Height mm	
Y100228	300	POA
Y100229	350	POA
Y100230	400	POA
Y100231	450	POA

Colour Options

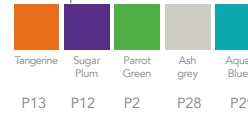

P13 P12 P2 P28 P29

*Please add colour choice onto the code when ordering *



New Product 5 Year Warranty

B. Opto

- Stackable solution for agile learning
- Easily reconfigured
- Stacks with tablet attached
- Rubber floor glides will suit any surface
- Integral shock absorber
- Tested for 110kg user weight
- 5 year warranty

Y100220	Opto 4 leg chair	POA
Y100221	Arms for above	POA
Y100222	Writing tablet & arm (RH only)	POA
Y100223	Linking mechanism	POA
Y100224	Transport dolly	POA

Colour Options



P27 P2 P28 P6 P30



Shock Absorber

Quantity rates available

Flow classroom chair



- Modern design
- Ergonomic style
- Angled legs to discourage tilting
- Waterfall seat front
- Light grey frame
- Stacks 5 high
- Chair linking available POA
- Orders of less than 10 chairs may carry a carriage charge

	Seat Height	Overall Width	
Y16540	260mm	350mm	POA
Y16541	310mm	350mm	POA
Y16542	350mm	400mm	POA
Y16543	380mm	400mm	POA
Y16544	430mm	460mm	POA
Y16545	460mm	460mm	POA

Y100122	Cantilever	460mm	POA
Y100123	Skid Base	460mm	POA

"This chair clearly considers all ergonomic factors for a modern classroom chair. In addition, the chair's aesthetics are design led whilst maintaining exceptional value for money. FIRA have recommended that the chair is put forward for the schools certification scheme - for products going beyond the standard BS EN1729."

- Levent Caglar, Senior Ergonomist & Head of Ergonomics Unit, FIRA.



15 Year Warranty

Express Delivery



Quantity rates available

Meet the family



Cantilever



Skid Base



High (see page 44)



Swivel (see page 150)

5 Year Warranty On Swivel Chair

For critical colour matching please ask for a sample

* Only available in 430mm and 460mm high

Frame colours														Frame colours			
P3	P12	P1	P14	P19	P25	P13	P27	P7	P31	P23	P32	P33	P34	P35	P4	F1	F13



21 Year Warranty

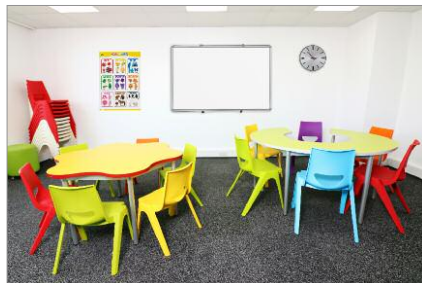

Quantity rates available

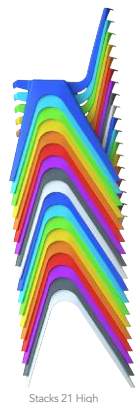

Stacks 21 High



Ideal dining and hall chair - 30 fit on a trolley

Posture Chairs

A. Chevron chair



- One Piece Polypropylene Chair
- Streamline Design for exceptional ergonomics, comfort and a modern look
- Stronger and Lightweight - glass filled polypropylene ensures greater strength and durability, yet lighter weight
- Space Saving Stack-ability - the chair stacks easily for efficient storage, up to 21 chairs within a 2 metre height
- Slim line curved legs for pleasing aesthetics
- Sustainable Materials - uses less materials than any other chair in its class. Made from fully recyclable materials
- Stacks 21 high
- 10 Colours available
- Orders of less than 30 chairs may carry a carriage charge

	Seat Height	Overall Width	
Y100142	260mm	400mm	POA
Y100143	310mm	400mm	POA
Y100144	350mm	460mm	POA
Y100145	380mm	460mm	POA
Y16717	430mm	500mm	POA
Y16718	460mm	500mm	POA
Y100116	Linking Device		POA

For critical colour matching please ask for a sample

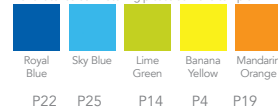

P22 P25 P14 P4 P19



P1 P12 P36 P27 P7

B. Trolley to take 30 chevron chairs

- Supplied flat packed for easy assembly
- Complete with ratchet strap

Y100118	each	POA
---------	------	-----

Posture Chairs

A. Positive Posture chairs

- The Titan chair is the first one-piece polypropylene chair that has attained EN1729 certification
- The benefit of one-piece polypropylene chairs is well documented in terms of their longevity (20 year guarantee), comfort and safety in the classroom
- With no screws or rivets, no sharp edges and no metal work to rust, the Posture chair offers all the benefits of a one-piece chair with the added EN1729 certification
- The Titan chair complies fully with EN1729 height regulations, but is also one of the few chairs that meets its posture and sitting position requirements
- Can be stacked 15 high & offers excellent value for money
- Orders of less than 30 chairs may carry a carriage charge

	Seat Height	Width	
Y15400	310mm	360mm	POA
Y15402	350mm	430mm	POA
Y15404	380mm	430mm	POA
Y15406	430mm	480mm	POA
Y15408	460mm	480mm	POA
Y15409	Linking Attachment	each	POA

†Sizes 310, 350 and 380 are not available in Burgundy, Grey, Black or Midnight Blue

*Please add colour choice onto the code when ordering *

For critical colour matching please ask for a sample



Best Seller 20 Year Warranty



- Hand hold
- Integral lumbar support
- Flat seat and waterfall front removes pressure points
- Leg rake to prevent tilting

A



Linking clip

Stackable 15 high



Orders for less than 10 chairs may carry a carriage charge

B. Ergo chair

- Latest ergonomic design
- Heavy duty - tested for 158kg user weight
- Fully recyclable
- Unique top edge gives a hand grip for safe lifting
- Advanced pelvic and lower spine support
- Stacks efficiently - 10 chairs take only 1500mm

	Seat Height	
Y100225	430	POA
Y100226	460	POA

For critical colour matching please ask for a sample



25 Year Warranty

New Product



Quantity rates available

B

10 Year Warranty



Quantity rates available

For seat dimensions see pages 277-280



A. Pennine posture chair



- Innovative design for perfect postural support
- Pelvic support back relieves pressure
- 10 year warranty
- Orders of less than 10 chairs may carry a carriage charge

	Seat Height	Overall Width	
Y100110	260mm	360mm	POA
Y100111	310mm	360mm	POA
Y100112	350mm	410mm	POA
Y100113	380mm	410mm	POA
Y100114	430mm	470mm	POA
Y100115	460mm	470mm	POA

*Please add colour choice onto the code when ordering *

Frame colours



Black Dark Grey Light Grey
F2 F11 F1

Shell colours



Leaf Mocha Pacific Scarlet Purple Ivory Slate Ebony
P9 P38 P3 P1 P12 P27 P26 P7

Page Link - see pages

For Upholstered Chairs see pages 265



B. Pennine plus chair

- Ideal for secondary and further education
- Robust, stylish chair with rounded back
- Pelvic support back relieves pressure
- Orders of less than 10 chairs may carry a carriage charge

Code	Seat Height	Overall Width	30+
Y100184	430	470	POA
Y100185	460	470	POA

Frame colours



Black Dark Grey Light Grey Ivory
F2 F11 F1 F15

Shell colours



Flame Indian Red Lavender Olive Peat Sand Sea Mist Sunshine Terracotta
P24 P1 P39 P40 P41 P42 P43 P44 P45

A. Folding event chairs - linking

- Integral linking feature, complies with fire regulations for performances, a much stronger solution than plastic linking clips
- These light weight folding chairs are extremely durable with a metal frame and the curved, supportive back provides additional comfort
- These chairs quickly fold and can be stored on the standard storage trolleys
- Weighs only 3.5kg
- Designed for occasional use, weight limit 100kg
- 1 year warranty
- Packed in 8's

		97+
Y15483	Blue Linking Chair	POA
Y15484	Burgundy Linking Chair	POA
Y15485	Grey Linking Chair	POA



Phone For Bulk Prices

Best Seller

A

B. Standard exam chairs

- Lightweight, folding exam chairs
- Tough, compact, versatile, suitable for indoor and outdoor event use
- The chairs fold flat in seconds and can be stored on trolleys with up to 60 chairs
- Fire retardant chairs (POA) and linking clips available
- Weight limit 100kg, designed for occasional use
- 1 year warranty
- Packed in 8's

		49+
Y16523	Blue Exam Chair	POA
Y16524	Burgundy Exam Chair	POA
Y16525	Grey Exam Chair	POA

Please specify the colour you require.



Express Delivery

Best Seller

B

Chair Trolleys



C. 40 chair flat trolley

- Suitable for most types of folding chairs
- 40 chair storage trolley with heavy duty castors
- L1780 x W780 x H1340mm
- Will fit through a standard doorway
- 5m ratchet strap included
- Requires simple self assembly

Y1548640	POA
----------	-----



D. 60 chair trolley

- 60 chair trolley with heavy duty castors and black frame
- L1750mm x W790mm x H1100mm (fully loaded)
- Will fit through normal doorway
- Requires simple self assembly

Y16527	POA
--------	-----

Larger trolleys also available - please enquire





A

Express Delivery
Ring for details

A. Graduate cantilever stool

- Waterfall seat front
- Scuff resistant & anti-tilt feet buffers
- Complies to EN1729
- 50 x 30mm oval frame
- Stacking 6 high
- Anthracite fully welded grey frame
- Height 610mm
- 5 year warranty on poly top stool and 1 year warranty on wood top stool

Y100195	Natural Wood Seat	POA
Y100177	Charcoal Poly Seat	POA



Page Link - see page
Craft tables 22



10 Year Warranty

Price Held For 2021

B



B. Olympic stool



- New innovative design
- Aerated, angled seat
- Heavy Duty frame with stable design
- Long lasting Duragrip feet
- Choose from 7 bright, modern seat colours and 3 frame colours
- Complies with EN1729
- 10 year warranty
- Please contact us for advice if these stools are to be used on abrasive safety flooring

	Seat Height	
Y19100	430mm	POA
Y19101	525mm	POA
Y19102	610mm	POA
Y19103	685mm	POA
Y19104	760mm	POA
Y155027	Tilting steel feet set of 4	POA

Frame Colours



F2 F6 F12

Shell Colours



P1 P13 P2 P29 P46 P5 P7 P12

For critical colour matching please ask for a sample

A. Solid beech stools

- These traditional stools are still extremely popular, especially in laboratories and art rooms
- Manufactured from solid beech, these stools will provide a solution that will last for many years
- Choose from 4 heights
- Orders of under 8 stools may incur a carriage charge

	Seat Height	
Y15000	510mm	POA
Y15002	560mm	POA
Y15004	610mm	POA
Y15006	685mm	POA

Fully
EN1729
Compliant



Express
Delivery

5 Year
Warranty

On All These
Products

A

B. Student lipped stool



- This stool is without a doubt the UK's best selling and most popular stool
- These stools are specified for major projects countrywide because of their unique seat shape and integral lumbar support
- The stools have a robust frame, unique lumbar support and a well positioned footrest
- The stools come in 10 shell colours with an option for steel feet and have a 5 year guarantee
- Please contact us for advice if these stools are to be used on abrasive safety flooring as steel feet may be necessary

	Seat Height	
Y15007A	395mm	POA
Y15008	445mm	POA
Y15010	560mm	POA
Y15012*	610mm	POA
Y15014*	685mm	POA
Y15016	Steel Feet - Set of 4	POA



B

C. Skid base stool

- Extremely strong and stable
- Same popular seat design
- Not suitable for abrasive floors

	Seat Height	
Y16729	395mm	POA
Y16730	445mm	POA
Y16731	560mm	POA
Y15015A*	610mm	POA
Y15017A*	685mm	POA

*Please add colour choice onto the code when ordering *

Seat Colours for Stools For critical colour matching please ask for a sample



Frame colours

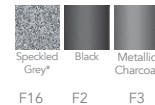

Phone
For Bulk
Prices

Express
Delivery on
Items
Marked*

Best
Seller

C

Phone For Bulk Prices

A

 FIRE RETARDANT Option In Blue & Charcoal



Rectangular Stools



- This highly popular stool has a 19mm sturdy tubular frame with a poly seat. Available in 4 heights
- Black, grey, charcoal or silver frame. Black will be supplied unless otherwise indicated
- Steel feet necessary for use on abrasive safety flooring
- Fire retardant option (blue and charcoal)
- Please contact us for advice if these stools are to be used on abrasive safety flooring
- Orders of less than 6 stools may incur a carriage charge

	Seat Height	30+
Y16712	430mm	POA*
Y16713	525mm	POA*
Y16714	610mm	POA*
Y16715	685mm	POA*
Y100227	Extra cost for Fire Retardancy	POA*
Y155027	Tilting steel feet set of 4	POA*

*Please add colour choice onto the code when ordering *

Shell Colours For critical colour matching please ask for a sample



Red P1 Yellow P4 Green P2 Emerald P16 Jade P17 Blue P3 Sapphire P17 Brown Charcoal Black Purple

Frame Colours

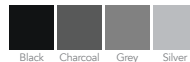

Black F2 Charcoal F17 Grey F6 Silver F4

Page Link - see page
Craft tables 22



10 Year Warranty

New Product

B



B. Pennine high chair



- Ergonomic design promotes good posture
- EN1729 compliant
- Optional saddle feet for use on abrasive floors

	Stool Height	
Y100217	525mm	POA
Y100218	610mm	POA
Y100219	685mm	POA

Please contact us for advice if the stools are to be used on abrasive safety flooring

Shell colours



Leaf P9 Mocha P38 Pacific P3 Scarlet P1 Purple P12 Ivory P27 Slate Ebony

Frame colours



Black F2 Dark Grey F11 Light Grey F1

Stools

A. Pennine posture stool

- Ergonomic design promotes good posture
- EN1729 compliant
- Optional saddle feet for use on abrasive floors



	Stool Height	
Y100179	430mm	POA
Y100180	525mm	POA
Y100181	610mm	POA
Y100182	685mm	POA
Y155026	Optional Saddle Feet Set	n/a

Shell colours



Frame colours



10 Year Warranty

A

Please contact us for advice if the stools are to be used on abrasive safety flooring

B. Mata High Stools

- Available with either sled or 4-leg frame
- Chrome or silver powder-coated frame option for 4-leg high stool
- Moulded polypropylene shell
- 7 standard colours: Black, White, Grey, Blue, Red, Olive, Mango
- Other shell colours available subject to minimum order quantity of 300
- Upholstered seat pad available on all chairs in the range

	Seat Height mm	
Y100127	620	POA
Y100128	730	POA
Y100129	730	POA

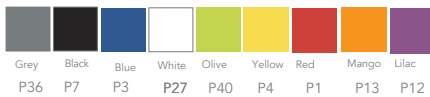

5 Year Warranty

B

C. Flow high chair

- Heavy duty construction
- 125kg weight limit
- Orders of less than 6 stools may incur a carriage charge



	Seat Height	
Y100125	4 Leg 610mm	POA
Y100126	4 Leg 660mm	POA
Y100133	Skid Frame 610mm	POA
Y100134	Skid Frame 685mm	POA

For critical colour matching please ask for a sample

* Only available in 430mm and 460mm high

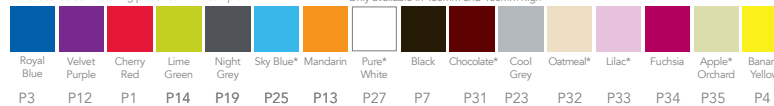

*Please add colour choice onto the code when ordering *



C



Exam Package

25 Exam Desks
1 Trolley (Y15474)

CODE: Y15476

Exam Desks & Trolleys

A. Exam package 1

- Great value package with 25 exam desks and a trolley
- Trolley holds 25 desks upright

Y15476	Package	POA
--------	---------	-----

Table & chair
hire available
- please ask for details

B. Exam package 2

- Great value package with 40 exam desks and a trolley
- Trolley holds 40 desks flat

Y100183	Package	POA
---------	---------	-----

C. Folding exam desks

- These popular exam tables have been designed to ensure they last longer and are better quality than others on the market
- The clips for the folding frame are metal and the tables have an 16mm beech laminate top with a pencil groove
- These tables provide a strong and affordable solution for all types of examination and with fold flat frames and easy to handle storage trolleys, exam preparation has never been easier
- 700mm high. Please order in multiples of 2.
- Beech standard, other colours available to order
- Also available with blue or grey polypropylene tops for a lighter option. Please ask for details
- Premium desk has a thicker desk top and a safety bar for easier and safer assembly



Holds 40 exam
desks lying flat



Y15472	Standard Exam Desk 600 x 600mm	POA
--------	-----------------------------------	-----

Y16554	Premium Exam Desk 600 x 600mm	POA
--------	----------------------------------	-----

D. Exam desk trolleys

- Hold either 25 exam desks upright for safe and easy storage or 40 exam desks lying flat

Y15474	Exam Desk Trolley Holds 25 Desks Upright	POA
--------	---	-----

Y15475	Exam Desk Trolley Holds 40 Desks Flat	POA
--------	--	-----

Exam Desks

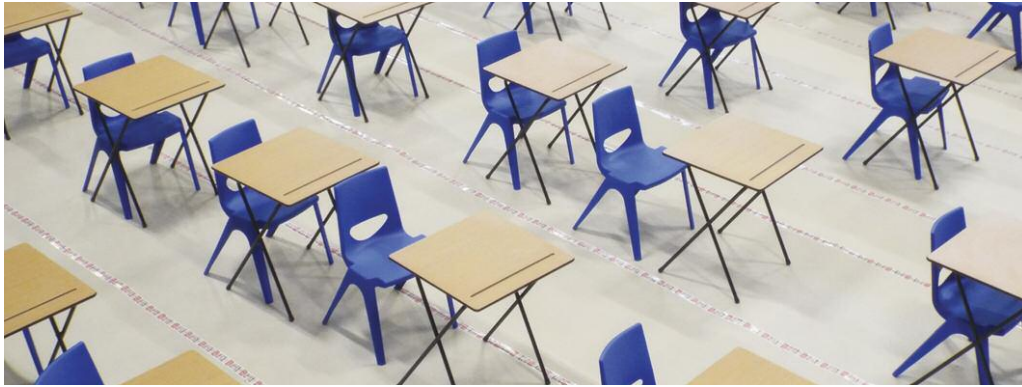

A. Tamperproof folding exam desk

- Ailsa Formica top resists graffiti
- Seamless, PU, impact-resistant edging
- Size: 600 x 600 x H700mm
- Pen groove included
- Speckled grey as standard, other colours available

Y100117 Tamperproof Folding Desk POA



Phone
For Bulk
Prices

A

B. Stacking exam tables

- These popular exam tables have a strong, black 'zimmer' frame and are FIRA tested to the highest level available, proving they are suitable for severe educational use
- Beech laminate top with MDF edge
- With pen groove
- 700mm high



Y16719 Stacking Exam Desk POA
600 x 500mm



Express
Delivery

B



Education resources come in all shapes and sizes
Are you storing yours in the most efficient way that makes the best use of space?



SPACES TAYLORED

Classroom Storage

Gratnells Trays	49	Colorstore	76
Best Selling Storage Units	51-53	Art Storage	76
Tray Storage	54	Bag Storage	78
Bookcases & Cupboards	55-63	Storage Trolleys	76-78
Cubby Storage	64	CalStor Storage	79-80
Tidistore	65-66	STEM Trolley	81-85
Premium Storage	67-69	Metal Storage	86-88
White Storage	69-71	Fitted Storage	89-96
Candy Colours	72-74		
Curved Bookcases	75		

Main Content Page

Classroom Storage

When it comes to updating classroom storage units, there are so many diverse requirements that it takes something beyond the average range to meet your needs. That's where we can help!

The following pages showcase our unique collection of storage products, from plastic tray storage units through to bespoke fitted systems. In most cases we trust you can find the ideal solution for your needs, but if not, or to discuss your requirements, please call our sales team. We have a wealth of experience and advice, available at absolutely no cost to you.



Classroom Storage

Gratnell's tray range for supply with storage units

- Gratnell's Trays are included in the price of our tray storage units in the following pages
- Trays are available in shallow, deep, extra deep and jumbo sizes.
- Some colours are not available in all sizes, see below for availability.
- You can specify the tray colours you want for any tray storage unit shown in this section, even mix and match depths from the range

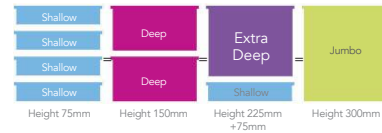

Tray colours available when purchasing shelving units:

Solid Colours



Clear Jelly Colours



Colorstore Range Only

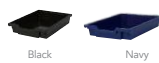

Page Link - see page
For
charge
lockers
159



Page Link - see page
For
power
trays
158



Gratnell's trays and lids for separate purchase

- Trays can also be purchased separately from units
- Flame Red, Yellow, Royal Blue, Green, Purple and Clear - available in all depths
- Orange, Pink, Cyan Blue and Lime - available in shallow and deep only
- Over 15 additional special colours available to order - ask for details



Stock Colours

All depths

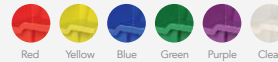

Shallow & Deep Only

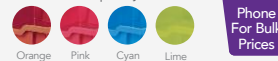

Phone
For Bulk
Prices

Special Colours - Please call for prices



Stock Colours

YSTRAY12	Shallow Tray	W312 x D427 x H75mm	pk 12	POA
YDTRAY6	Deep Tray	W312 x D427 x H150mm	pk 6	POA
YEDTRAY6	Extra Deep Tray	W312 x D427 x H225mm	pk 6	POA
YJTRAY6	Jumbo Tray	W312 x D427 x H300mm	pk 6	POA
YTLID6	Clear Tray Lid		pk 6	POA

Tray Storage Units Overview

Checklist for Choosing and Specifying Your Unit

1. How many trays do you need?
2. And of what depth? Note that within the price you can specify any mix of depths which will physically fit the unit. 1 x Deep tray = 2 x Shallow, 1 x Extra Deep = 3 x Shallow and 1 x Jumbo = 4 x Shallow.
3. Is there a preferred, uniform, top surface height? Look for the height icon h1, h2 etc which gives the height in mm.
4. How many bays wide for best fit into your workspaces? Units are available in 1, 2, 3 or even 4 columns of trays wide.
5. Carcass design - trays sliding on runners or sitting directly onto a shelf?
6. Castors or Fixed Plinth? Smaller units are fitted with castors as standard but some items can be specified with a static plinth at no extra cost. Note: heights quoted include height of castors.
7. Doors - locking doors can be fitted to most units as an optional extra.
8. Wood finish / Metal Frame Colours - Our standard MFC wood finishes are Beech (BE) or Maple (MP) but please ask for details of production order quantities and lead times for manufacturing in Ash, White, or other special finishes. Standard Metal Frame colour options are Silver, Powder Blue & Yellow. See page 90 for colour icons.
9. Select your mix of tray colours (and depths) from the extensive range available - see chart on page 52.

For fitted installations see Teaching Wall system on pages 89-96.



65mm Castors

Plinth

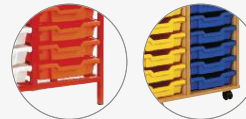

Best Selling Storage Units



- All units supplied complete with Gratnell's trays within the price. See page 52 for colours and size options
- Choice of Beech or Maple finish. Ask our sales office for details on other finishes available
- Colour and size options: you can fill your unit with any combination of tray depth and colour which will fit into the space



A. 6 tray unit

- W360 x D453 x H617mm

Y15116	Beech, Open Front
Y15118	Beech with Locking Door
Y203000	Maple, Open Front
Y203002	Maple with Locking Door



B. 12 tray unit

- W700 x D453 x H617mm

Y15120	Beech, Open Front
Y15122	Beech with Locking Door
Y203004	Maple, Open Front
Y203006	Maple with Locking Door



C. 18 tray unit

- W1030 x D453 x H617mm

Y15124	Beech, Open Front
Y15126	Beech with Locking Door
Y203008	Maple, Open Front
Y203010	Maple with Locking Door



D. 24 tray unit

- W1030 x D453 x H789mm

Y15128	Beech, Open Front
Y15130	Beech with Locking Door
Y203012	Maple, Open Front
Y203014	Maple with Locking Door



Best Selling Storage Units



- All units supplied complete with Grathnell's trays within the price. See page 52 for colours and size options
- Choice of Beech or Maple finish. Ask our sales office for details on other finishes available
- Colour and size options: you can fill your unit with any combination of tray depth and colour which will fit into the space



h5
height
961mm

A. 30 tray unit

- W1030 x D453 x H961mm

Y17005	Beech, Open Front
Y17007	Beech with Locking Door
Y203016	Maple, Open Front
Y203018	Maple with Locking Door



h3
height
703mm

B. 21 tray units

- W1030 x D453 x H703mm

Y15125	Beech, Open Front
Y15127	Beech with Locking Door
Y203020	Maple, Open Front
Y203022	Maple with Locking Door



h4
height
789mm

C. 8 & 16 tray units

- D453 x H789mm
- 8 tray unit width 360mm, 16 tray unit width 700mm

	No Doors	With Doors
Beech 8 Tray Unit	Y15119	Y15119WD
Beech 16 Tray Unit	Y15123	Y15123WD
Maple 8 Tray Unit	Y203024	Y203024WD
Maple 16 Tray Unit	Y203026	Y203026WD



h4
height
789mm

h2
height
617mm

D. 6 & 8 tray shelving units

- W1030 x D453mm
- 6 tray height 617mm, 8 tray height 789mm
- 2 adjustable shelves

	No Doors	With Doors
Beech 6 Tray	Y15129	Y15129WD
Beech 8 Tray	Y15131	Y15131WD
Maple 6 Tray	Y203028	Y203028WD
Maple 8 Tray	Y203030	Y203030WD



Four Column Tray Units



- All units supplied complete with Gratnell's trays within the price. See page 52 for colours and size options
- Choice of Beech or Maple finish. Ask our sales office for details on other finishes available
- Colour and size options: you can fill your unit with any combination of tray depth and colour which will fit into the space



A. 64 shallow tray unit

- W1358 x D462 x H1477mm

Y15716	Beech Open Front
Y15716D	Beech with Doors
Y203032	Maple Open Front
Y203032D	Maple with Doors



B. 48 shallow tray unit

- W1358 x D462 x H1133mm

Y15133	Beech Open Front
Y15133D	Beech with Doors
Y203034	Maple Open Front
Y203034D	Maple with Doors



C. 40 shallow tray unit

- W1358 x D462 x H961mm

Y15713	Beech Open Front
Y203036	Maple Open Front



D. 32 shallow tray unit

- W1358 x D462 x H789mm

Y15705	Beech Open Front
Y15707	Beech, with Locking Doors
Y203038	Maple Open Front
Y203040	Maple, with Locking Doors



E. 28 shallow tray unit

- W1358 x D462 x H703mm

Y15710	Beech Open Front
Y15711	Beech, with Locking Doors
Y203042	Maple Open Front
Y203044	Maple, with Locking Doors



F. 24 shallow tray unit

- W1358 x D462 x H617mm

Y15733	Beech Open Front
Y15737	Beech, with Locking Doors
Y203046	Maple Open Front
Y203048	Maple, with Locking Doors



G. 20 shallow tray unit

- W1358 x D462 x H531mm

Y15719	Beech Open Front
Y15719D	Beech with Doors
Y203050	Maple Open Front
Y203050D	Maple with Doors

Colours



Tray Storage Cupboards



- All cupboards supplied with trays included in the price. Specify any combination of sizes and colours which will fit into the tray compartment
- Choice of Beech or Maple finish. Ask our sales office for details on other finishes available



Can also be supplied with different tray sizes



A. 21 tray cupboard unit

- Tray storage for 21 trays and 3 additional shelves
- W1030 x D477 x H1810mm

Y15172	Beech with Locking Doors
Y203052	Maple with Locking Doors



B. 24 tray cupboard unit

- Storage for 24 trays and 2 additional shelves
- Full or half doors available
- W1030 x D477 x H1468mm

Y15728	Beech, Locking Top Doors
Y15738C	Beech, Locking Full Doors
Y203054	Maple, Locking Top Doors
Y203056	Maple, Locking Full Doors



C. 48 tray cupboard unit

- W1030 x D477 x H1468mm

Y17081	Beech Open Front
Y17083	Beech, with Locking Doors
Y203058	Maple Open Front
Y203060	Maple, with Locking Doors

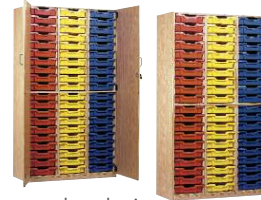

D. 60 tray cupboard unit

- W1030 x D477 x H1810mm

Y15178	Beech Open Front
Y15176	Beech, with Locking Doors
Y203062	Maple Open Front
Y203064	Maple, with Locking Doors

Colours



Open Bookcases



- This popular range of open bookcases has been specifically designed for severe classroom environments
- All now available in Beech, Maple or White finish
- Strong, 25mm bend-resistant shelves



Best Seller



A. Bookcase 750

- 2 adjustable shelves
- W900 x D320 x H750mm

Y15183	Beech
Y200050	Maple
Y200051	White



B. Bookcase 1000

- 2 adjustable shelves
- W900 x D320 x H1000mm

Y15182	Beech
Y200052	Maple
Y200053	White



C. Bookcase 1250

- 1 fixed and 2 adjustable shelves
- W900 x D320 x H1250mm

Y15193	Beech
Y200054	Maple
Y200055	White



Bend-resistant 25mm shelves



D. Bookcase 1500

- 1 fixed and 2 adjustable shelves
- W900 x D320 x H1500mm

Y15731	Beech
Y200056	Maple
Y200057	White



E. Bookcase 1800

- 1 fixed and 4 adjustable shelves
- W900 x D320 x H1800mm

Y15186	Beech
Y200058	Maple
Y200059	White



All now available in White MFC finish



Page Link - see pages
For library units... 193-195



Lockable Storage Cupboards



- This popular range of storage cupboards has been specifically designed for severe classroom environments
- All now available in Beech, Maple or White finish
- Strong, 25mm bend-resistant shelves



Best Seller



A. Cupboard 750

- 2 adjustable shelves
- W1030 x D477 x H768mm

Y15181	Beech
Y200070	Maple
Y200071	White



B. Cupboard 1000

- 1 fixed and 2 adjustable shelves
- W1030 x D477 x H1018mm

Y15180	Beech
Y200072	Maple
Y200073	White



C. Cupboard 1250

- 1 fixed and 2 adjustable shelves
- W1030 x D477 x H1268mm

Y15191	Beech
Y200074	Maple
Y200075	White



D. Cupboard 1500

- 1 fixed and 2 adjustable shelves
- W1030 x D477 x H1518mm

Y15730C	Beech
Y200076	Maple
Y200077	White



E. Cupboard 1800

- 1 fixed and 4 adjustable shelves
- W1030 x D477 x H1818mm

Y15184	Beech
Y200078	Maple
Y200079	White



Bend-resistant 25mm shelves



All now available in White MFC finish

Carcass colours



Coloured Edge Storage



- All units supplied complete with Gratnell's trays within the price. See page 52 for colours and size options
- Supplied in Beech



For Ash finish, please add 'JA' to the end of the code



A. 12 jumbo tray unit

- W1358 x D453 x H1067mm

Y15200 With Red Edge

Y15202 With Blue Edge

Y15204 With Green Edge



B. 8 jumbo tray unit

- W1358 x D453 x H739mm

Y15231 With Red Edge

Y15233 With Blue Edge

Y15235 With Green Edge

h4
height
789mm



C. 24 shallow tray unit

- W1030 x D453 x H789mm

Y15194 With Red Edge

Y15196 With Blue Edge

Y15198 With Green Edge

h2
height
617mm



D. 18 shallow tray unit

- W1030 x D453 x H617mm

Y15188 With Red Edge

Y15190 With Blue Edge

Y15192 With Green Edge

h2
height
617mm



E. 12 shallow tray unit

- W700 x D453 x H617mm

Y17100 With Red Edge

Y17102 With Blue Edge

Y17104 With Green Edge

h2
height
617mm



F. 6 shallow tray unit

- W360 x D453 x H617mm

Y17106 With Red Edge

Y17108 With Blue Edge

Y17110 With Green Edge



Page Link - see pages

For early
years
units...

125-126



Coloured Edge Bookcases & Cupboards



- Popular range of open shelf or cupboard storage with the enhancement of colour edging trims
- Strong 25mm bend-resistant shelves
- Supplied in Beech



Bend-resistant
25mm shelves



A. High bookcase unit

- 1 fixed and 4 adjustable shelves
- Open Bookcases W900 x D320 x H1800mm

Y15223 Bookcase - Red Edge

Y15227 Bookcase - Blue Edge

Y15229 Bookcase - Green Edge



B. Medium bookcase unit

- 1 fixed and 2 adjustable shelves
- Open Bookcases W900 x D320 x H1250mm

Y15212 Bookcase - Red Edge

Y15214 Bookcase - Blue Edge

Y15216 Bookcase - Green Edge



C. Low bookcase unit

- 2 adjustable shelves
- Open Bookcases W900 x D320 x H750mm

Y15211 Bookcase - Red Edge

Y15213 Bookcase - Blue Edge

Y15215 Bookcase - Green Edge



D. Low cupboard unit

- 2 adjustable shelves
- Cupboards with doors W1030 x D477 x H768mm

Y15201 Cupboard - Red Edge

Y15203 Cupboard - Blue Edge

Y15205 Cupboard - Green Edge



E. Medium cupboard unit

- 1 fixed and 2 adjustable shelves
- Cupboards w/doors W1030 x D477 x H1268mm

Y15206 Cupboard - Red Edge

Y15208 Cupboard - Blue Edge

Y15210 Cupboard - Green Edge



F. High cupboard unit

- 1 fixed and 4 adjustable shelves
- Cupboards w/doors W1030 x D477 x H1818mm

Y15217 Cupboard - Red Edge

Y15219 Cupboard - Blue Edge

Y15221 Cupboard - Green Edge



Jumbo Storage Units



- These units are extremely popular, offering organised storage capacity for large, messy and heavy items
- All units supplied complete with Grattnell's trays within the price. See page 52 for colours and size options
- Choice of Beech or Maple finish. Ask our sales office for details on other finishes available



Extra Value

A. 12 jumbo tray unit

- W1358 x D453 x H1067mm

Y15148 Beech, Open Front

Y15150 Beech with Locking Doors

Y203065 Maple, Open Front

Y203066 Maple with Locking Doors



Extra Value

B. 8 jumbo tray unit

- W1358 x D453 x H739mm

Y157198 Beech, Open Front

Y157208 Beech with Locking Doors

Y203068 Maple, Open Front

Y203070 Maple with Locking Doors



C. 9 jumbo tray unit

- W1030 x D453 x H1067mm

Y15137 Beech, Open Front

Y15143 Beech with Locking Doors

Y203072 Maple, Open Front

Y203074 Maple with Locking Doors



D. 6 jumbo tall tray unit

- W700 x D453 x H1067mm

Y17045 Beech, Open Front

Y17047 Beech with Locking Doors

Y203076 Maple, Open Front

Y203078 Maple with Locking Doors



E. 6 jumbo wide tray unit

- W1030 x D453 x H739mm

Y17049 Beech, Open Front

Y17051 Beech with Locking Doors

Y203080 Maple, Open Front

Y203082 Maple with Locking Doors



F. 4 jumbo tray unit

- W700 x D453 x H739mm

Y17053 Beech, Open Front

Y17055 Beech with Locking Doors

Y203084 Maple, Open Front

Y203086 Maple with Locking Doors



Colours



Maple Beech



Deep & Extra Deep Storage Units



- These units are extremely popular, offering organised storage capacity for large, messy and heavy items
- All units supplied complete with Gratnell's trays within the price.
- Choice of Beech or Maple finish. Ask our sales office for details on other finishes available



A. 12 deep tray unit vertical
• W1030 x D453 x H835mm

Y20021	Beech Open Front
Y200210D	Beech with Door
Y203088D	Maple with Door



B. 12 deep tray horizontal
• W1358 x D453 x H707mm

Y200212	Beech Open Front
Y203090	Maple Open Front



C. 16 deep tray unit
• W1348xD453xH835mm

Y200214	Beech Open Front
Y203092	Maple Open Front



D. 18 deep tray unit
• W1030 x D453 x H1210mm

Y200216	Beech Open Front
Y203094	Maple Open Front



E. 6 extra deep tray unit
• W700 x D453 x H857mm

Y17061	Beech, Open Front
Y17063	Beech with Locking Doors
Y203096	Maple, Open Front
Y203098	Maple with Locking Doors



F. 12 extra deep tray unit
• W1358 x D453 x H857mm

Y1571912	Beech, Open Front
Y1572012	Beech with Locking Doors
Y203100	Maple, Open Front
Y203102	Maple with Locking Doors



G. 16 extra deep tray unit
• W1358 x D453 x H1115mm

Y1572516	Beech, Open Front
Y1572616	Beech with Locking Doors
Y203104	Maple, Open Front
Y203106	Maple with Locking Doors

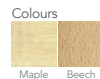

Page Link - see pages
More extra deep units... [62-66](#)



Combination Storage Units



- Choice of Beech or Maple finish
- All units can also be made as static unit, fitted with plinth at no extra cost - specify if required
- All units supplied complete with Gragnells trays within the price - See page 52 for colour options
- Units can be combined with the open shelf unit on the following page to make tall units



A. 10 tray open front variety unit

- Unit holds 4 extra deep trays on the left and 12 shallow or 6 deep trays on the right
- W1358 x D453 x H617mm

Y15729	Beech Mobile - Open Front
Y1573610	Beech, Static - Open Front
Y203108	Maple Mobile - Open Front
Y203110	Maple, Static - Open Front



C. 32 shallow or 16 deep tray unit

- Allows a mixture of shallow and deep trays
- W1358 x D453 x H835mm

Y15132	Beech, Open Front
Y15134	Beech with Locking Doors
Y203116	Maple, Open Front
Y203118	Maple with Locking Doors



B. 24 shallow or 12 deep tray unit

- Allows a mixture of shallow and deep trays
- W1358 x D453 x H707mm

Y17057	Beech, Open Front
Y17059	Beech with Locking Doors
Y203112	Maple, Open Front
Y203114	Maple with Locking Doors



D. 36 shallow or 18 deep tray unit

- A popular, large capacity unit with 36 shallow or 18 deep trays, or a combination of both
- W1030 x D453 x H1210mm

Y15140	Beech, Open Front
Y15142	Beech with Locking Doors
Y203120	Maple, Open Front
Y203122	Maple with Locking Doors

Combination & Sliding Door Tray Units



- Choice of Beech or Maple finish
- All units can also be made as static unit, fitted with plinth at no extra cost - specify if required
- All units supplied complete with Grattells trays within the price - See page 52 for colour option
- Tray units can be combined with the open shelf unit below to make tall units
- Sliding doors are lockable



A. 16 shallow, 4 deep and 3 extra deep tray unit

- Dimensions: w1358 x h842mm
Units without doors have depth 453mm
Units with sliding doors have depth 510mm

Y15145 Beech, 23 Tray, Open Front

Y15741 Beech, 23 Tray, Sliding Doors

Y203124 Maple, 23 Tray, Open Front

Y203126 Maple, 23 Tray, Sliding Doors



C. 16 shallow and 6 extra deep tray unit

- Dimensions: w1358 x h842mm
Units without doors have depth 453mm
Units with sliding doors have depth 510mm

Y17067 Beech, 22 Tray, Open Front

Y15745 Beech, 22 Tray, Sliding Doors

Y203132 Maple, 22 Tray, Open Front

Y203134 Maple, 22 Tray, Sliding Doors



B. 8 deep and 6 extra deep tray unit

- Dimensions: w1358 x h842mm
Units without doors have depth 453mm
Units with sliding doors have depth 510mm

Y17065 Beech, 14 Tray, Open Front

Y15743 Beech, 14 Tray, Sliding Doors

Y203128 Maple, 14 Tray, Open Front

Y203130 Maple, 14 Tray, Sliding Doors



D. Open shelf unit with 4 compartments

- Sits on top of base units
- Can be securely fixed with locking pins

Y203136 Beech Finish

Y203138 Maple Finish



Colours



Maple Beech

Pick & mix your trays

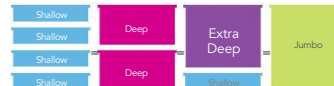

Phone
For Bulk
Prices

Variety Storage Units

- Choice of Beech or Maple finish
- Items A and B can also be made as static unit, fitted with plinth at no extra cost - specify if required
- All units supplied complete with Gratrrells trays within the price - See page 52 for colour options

Colours



Maple Beech



A. 12 tray variety

- Takes 4 jumbo trays, 4 deep trays and 4 shallow trays, mix and match colours as you wish
- W1358 x D453 x H707mm

Y15156	Beech, Mobile, Open Front
Y15158	Beech, Mobile, Locking Doors
Y15162	Beech, Static, Locking Doors
Y203140	Maple, Mobile, Open Front
Y203142	Maple, Mobile, Locking Doors
Y203144	Maple, Static, Locking Doors



C. 12 tray vertical variety

- Contains 3 of each tray size: shallow, deep, extra deep & jumbo
- W1030 x D453 x H967mm

Y202000	Beech, Mobile, Open Front
Y203146	Maple, Mobile, Open Front
Y202000D	Beech, Mobile, with Doors
Y203146D	Maple, Mobile, with Doors



B. 16 tray variety

- A bigger version of the unit above, this variety tray storage unit holds 4 shallow trays, 4 deep trays, 4 extra deep trays, and 4 jumbo trays
- W1358 x D453 x H967mm

Y15164	Beech, Mobile, Open Front
Y15166	Beech, Mobile, Locking Doors
Y15170	Beech, Static, Locking Doors
Y203148	Maple, Mobile, Open Front
Y203150	Maple, Mobile, Locking Doors
Y203152	Maple, Static, Locking Doors



D. 8 tray narrow variety unit

- Takes 2 x shallow, 2 x deep, 2 x extra deep, 2 x jumbo
- W700 x D453 x H967mm

Y151108	Beech, Mobile, Open Front
Y203156	Maple, Mobile, Open Front
Y151108D	Beech, Mobile, with Doors
Y203156D	Maple, Mobile, with Doors

Cubby Range



- Smaller sizes than our regular tray storage range, so ideal for younger years, or where space is limited
- Units supplied fully assembled
- Beech-BE finish only
- Units supplied with Cubby trays included in the price



The Gratnell's Cubby Trays are **smaller** than the standard Gratnell's Trays:
W260 x D312 x H150mm



A. 6 tray unit

- W588 x D343 x H647mm

YEY8006



B. 12 tray unit

- W1158 x D343 x H647mm

YEY8012



C. 18 tray unit

- W873 x D343 x H1211mm

YEY8018



D. 24 tray unit

- W1158 x D343 x H1211mm

YEY8024



E. 12 deep and 4 extra deep tray unit

- W1158 x D343 x H1194mm
- Includes 4 extra deep Gratnell's trays & 12 Cubby trays

YEY8013



F. 30 tray unit

- W1443 x D343 x H1211mm

YEY8030

Trays available in:

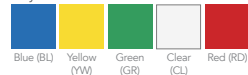

Tidistore Storage Range



- The Tidistore Storage Units are a versatile stackable storage solution that can be customised to suit every classroom
- Each unit comes complete with castors and locating pins which are used when stacking
- All Tidistore units can be stacked with each other to make a whole combination of different storage requirements
- All units come fully assembled in either Beech or Maple carcass - please specify. Ask our sales office for details on other finishes available
- All units supplied complete with Gratnell's trays within the price. See page 52 for colour and size options
- Height includes 65mm castors



Stackable



A. Tidistore 24 shallow tray unit

- W1030 x D453 x H810mm

Y15128AS	Beech
Y203160	Maple



B. Tidistore 12 deep tray unit

- W1030 x D453 x H810mm

Y1524512	Beech
Y203162	Maple



C. Tidistore 6 jumbo tray unit

- W1030 x D453 x H810mm

Y152476	Beech
Y203164	Maple



D. Tidistore 16 shallow tray unit

- W700 x D453 x H810mm

Y15249	Beech
Y203166	Maple



E. Tidistore 8 deep tray unit

- W700 x D453 x H810mm

Y15245	Beech
Y203168	Maple



F. Tidistore 4 jumbo tray unit

- W700 x D453 x H810mm

Y15247	Beech
Y203170	Maple

Tidistore Storage Range



A. Tidistore unit with 1 shelf
 • W700 x D453 x H810mm

Y15241	Beech
Y203172	Maple



B. Tidistore unit with 4 compartments
 • W700 x D453 x H810mm

Y15243	Beech
Y203174	Maple



C. Tidistore beech storage cupboard
 • Static, stackable storage unit c/w 1 shelf
 • Locking doors
 • W700 x D475 x H745mm

Y200010	Beech
---------	-------

Page Link - see page
 For buying guide... 50

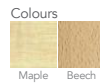

These items are Stackable



Premium Storage Range



- New range of premium storage units in a choice of White or Grey finish
- Add a choice of brightly coloured trays for a clean, modern look
- All tray units contain clear Grattells plastic tray runners
- Units are supplied with plinths as standard, but most are also available fitted with castors at no additional charge - please ask for details
- All units supplied complete with Grattells trays as shown, within the price
- See page 52 for colour & size options.



A.6 tray unit
• W363 x D475 x H617mm

Y203182	White, No Doors
Y203184	White, with Locking Doors
Y203186	Grey, No Doors
Y203188	Grey, with Locking Doors



B.8 tray unit
• W363 x D475 x H789mm

Y203190	White, No Doors
Y203192	White, with Locking Doors
Y203194	Grey, No Doors
Y203196	Grey, with Locking Doors



C.12 tray unit
• W704 x D475 x H617mm

Y203198	White, No Doors
Y203200	White, with Locking Doors
Y203202	Grey, No Doors
Y203204	Grey, with Locking Doors



D.16 tray unit
• W704 x D475 x H789mm

Y203206	White, No Doors
Y203208	White, with Locking Doors
Y203210	Grey, No Doors
Y203212	Grey, with Locking Doors



E.18 tray unit
• W1045 x D475 x H617mm

Y203214	White, No Doors
Y203216	White, with Locking Doors
Y203218	Grey, No Doors
Y203220	Grey, with Locking Doors



F.24 tray unit
• W1045 x D475 x H789mm

Y203222	White, No Doors
Y203224	White, with Locking Doors
Y203226	Grey, No Doors
Y203228	Grey, with Locking Doors

Premium Storage Range



- New range of premium storage units in a choice of White or Grey finish
- Add a choice of brightly coloured trays for a clean, modern look
- All tray units contain clear Gratnells plastic tray runners
- Units are supplied with plinths as standard, but most are also available fitted with castors at no additional charge - please ask for details
- All units supplied complete with Gratnells trays as shown, within the price
- See page 52 for colour & size options



h2
height
617mm

A. 6 tray shelving unit

- 2 shelf compartment & 6 shallow trays
- W1045 x D475 x H617mm

Y203230 White, No Doors

Y203232 White, with Locking Doors

Y203234 Grey, No Doors

Y203236 Grey, with Locking Doors



h4
height
789mm

B. 8 tray shelving unit

- 2 shelf compartment & 8 shallow trays
- W1045 x D475 x H789mm

Y203238 White, No Doors

Y203240 White, with Locking Doors

Y203242 Grey, No Doors

Y203244 Grey, with Locking Doors



h8
height
1818mm

C. 21 tray cupboard

- W1045 x D475 x H1818mm
- Supplied c/w 21 trays

Y203246 White, with Locking Doors

Y203248 Grey, with Locking Doors



h2
height
617mm

D. Low cupboard

- W1045 x D465 x H617mm

Y203250 White, No Doors

Y203252 White, with Locking Doors

Y203254 Grey, No Doors

Y203256 Grey, with Locking Doors



h4
height
789mm

E. Medium cupboard

- W1045 x D475 x H789mm

Y203258 White, No Doors

Y203260 White, with Locking Doors

Y203262 Grey, No Doors

Y203264 Grey, with Locking Doors



h8
height
1818mm

F. Tall cupboard

- W1045 x D475 x H1818mm

Y203266 White, No Doors

Y203268 White, with Locking Doors

Y203270 Grey, No Doors

Y203272 Grey, with Locking Doors

White Range



- 12 popular tray units available in white finish
- Supplied complete with trays
- Remember to state your choice of tray colours
- See page 52 for tray colours

Phone
For Bulk
Prices



A. 4 jumbo tray unit
• W700 x D453 x H739mm

Y17053W



B. 8 jumbo tray unit
• W1358 x D453 x H739mm

Y157198W



C. 12 jumbo tray unit
• W1358 x D453 x H1067mm

Y15148W



D. 6 jumbo wide tray unit
• W1030 x D453 x H739mm

Y203180



White Range



Page Link - see page

For
buying
guide...

50



A. 12 variety tray unit
• W1358 x D453 x H707mm

Y15156W



B. 16 variety tray unit
• W1358 x D453 x H967mm

Y15164W Mobile



C. 12 extra deep tray unit
• W1358 x D453 x H857mm

Y1571912W



D. 16 extra deep tray unit
• W1358 x D453 x H1115mm

Y1572516W



E. 12 deep tray unit
• W1358 x D453 x H707mm

Y17057W



F. 16 deep tray unit
• W1358 x D453 x H835mm

Y15132W



G. 18 deep tray unit
• W1030 x D453 x H1210mm

Y17080W



H. 12 deep tray unit
• W1030 x D453 x H835mm

Y17084W



I. 8 deep & 6 extra deep tray unit
• W1358 x D453 x H842mm

Y17065W

14 Tray Unit

Stackable White Storage Units

- New range of stacking modular storage units
- By using just 4 component modules many different storage combinations can be built
- Supplied fully assembled

Units stacked over 2 metres tall will require wall fixing



A. 4 squares unit
• W700 x D453 x H745mm

Y200020



B. 4 jumbo tray unit
• W700 x D453 x H810mm

Y200022



C. Unit with 1 shelf
• Open unit: W700x D453 x H745mm
• Cupboard unit: W700 x D475 x H745mm

Y200024 Open Unit

Y200026 Lockable Cupboard

White Display Shelving

- Value range of open display units in white MFC finish
- Supplied fully assembled



Page Link - see page

More white furniture 303-314



D. Small display unit

Y300500 W1300 x D450 x H660mm



E. Medium display unit

Y300502 W1030 x D450 x H1004mm

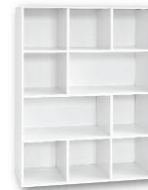

F. Tall display unit

Y300504 W1030 x D450 x H1330mm

The Candy Colours Range



- All units supplied complete with Gratnell's trays within the price. See page 52 for colours and size options
- Please specify top rail theme colour - Lime Green, Cyan Blue, Tangerine or White



A. 6 bay kinderbox with 12 shallow or 6 deep trays

- W1022 x D473 x H600mm

Y17023 6 Bay Kinderbox



B. Candy book house

- Made from 18mm Japanese Ash MFC with ply effect edging
- Choose from Lime, Tangerine and Cyan
- Dimensions: W910 x D568 x H1101mm

YBH9000 Book House with Trays



C. Mobile art storage cupboard

- Made in Japanese Ash MFC with bright coloured interior door panels
- W1085 x D600 x H1503mm
- Supplied with 16 x shallow gratnell's trays (or equivalent in larger trays)
- Other contents not included

Y17038 Art Storage Cupboard

Please specify colour

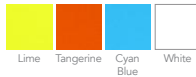

Page Link - see pages

Early years & Candy Colours cloakroom range

136



Page Link - see pages

Book shelves & library furniture

193-195



D. 6 bay kinderbox (coloured inner panels)

Y17033 With Wheels
W886 x D600 x H273mm

Y17035 With Legs
W886 x D600 x H430mm



E. Angled tray unit c/w 6 deep trays

- W1030 x D481 x H898mm

Y200190 Angled Shelf Unit

Candy Colours Room Dividers

- Backless storage units which can be used free standing or stacked on top of co-ordinating cupboards for additional storage space
- Please specify panel colour – Lime Green, Cyan Blue, Tangerine or White
- Each compartment will hold 1 jumbo Gratnell's tray if required (priced separately, See page 52) – inner dimensions W316 x D450 x H310mm
- Supplied with a set of plastic feet & connecting pins
- Maximum recommended stacking height 2 metres

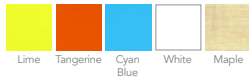

A. 4 cube (2 x 2)
• W700 x D453 x H774mm

Y17200



B. 6 cube (2 x 3)
• W1030 x D453 x H774mm

Y17202

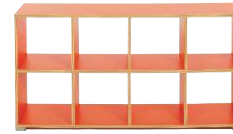

C. 8 cube (2 x 4)
• W1358 x D453 x H774mm

Y17206



D. 6 cube (3 x 2)
• W700 x D453 x H1002mm

Y17204



E. 9 cube (3 x 3)
• W1030 x D453 x H1002mm

Y17208



F. 12 cube (3 x 4)
• W1358 x D453 x H1002mm

Y17210

Storage Cupboards

- Low level cupboards
- Vertical divider creates 2 compartments with 1 adjustable shelf each side
- Solid back, doors with silver handles
- Supplied with a set of plastic feet & connecting pins
- Use with room dividers to give extra height & storage space
- Maximum recommended stacking height 2 metres
- Can be used as base units for the room dividers on page 76

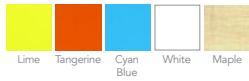

A. Cupboard 700mm Wide

Y17212 W700 x D453 x H500mm
use with A & D



B. Cupboard 1030mm Wide

Y17214 W1030 x D453 x H500mm
use with B & E



C. Cupboard 1358mm Wide

Y17216 W1358 x D453 x H500mm
use with C & F



Combine room dividers with complementary storage cupboards (see next page)



Page Link - see pages
For waterfall units... 193



Please ask for pricing on special colours

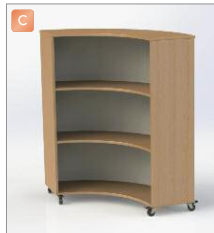

Concave

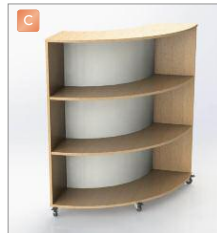

Convex

Wood & colour finishes may not be representative of actual colours - please ask for a sample



Grasmere Curve Book Storage System

- Premium range made from high quality 18mm MFC in a choice of board finishes with cream back boards
- Choice of either single sided bookcases in 2 heights, or double sided mobile units in 3 different heights
- Other board finishes available - please ask for pricing and details

A. Grasmere straight bookcase

- Single sided
- Depth 320mm

		Shelves	
Y200600	H900 x W1000mm	2	each
Y200604	H900 x W600mm	2	each

B. Grasmere straight bookcase

- Double sided
- Depth 600mm

		Shelves	
Y200610	H900 x W1000mm	2	each
Y200612	H1200 x W1000mm	2	each
Y200614	H1500 x W1000mm	3	each
Y200616	H900 x W600mm	2	each
Y200618	H1200 x W600mm	2	each
Y200620	H1500 x W600mm	3	each

C. Grasmere curved bookcase

- Single sided
- Choice of concave (curves inwards) or convex (curves outwards)
- Maximum depth 835mm, width 1180mm

		Shelves	
Y200630	Convex H900	2	each
Y200632	Concave H900	2	each
Y200634	Convex H1200	2	each
Y200636	Concave H1200mm	2	each

D. Grasmere curved bookcase

- Double sided
- Maximum depth 1115mm x width 1575mm

		Shelves	
Y200640	Convex H900mm	2	each
Y200642	Convex H1200mm	2	each
Y200644	Convex H1500mm	3	each
Y200646	Concave H900mm	2	each
Y200648	Concave H1200mm	2	each
Y200650	Concave H1500mm	3	each

Art Room Storage



- Please specify Beech (BE) or Maple (MP) carcass.
Ask our sales office for details on other finishes available



A. Static plan chest

- With beech or coloured drawers
- 6 drawers designed to hold A1 paper
- W1015 x D750 x H780mm

Y16016	Beech/Maple Drawers
Y17069	Coloured Drawers



B. Mobile paper storage

- 4 sliding drawers designed to hold A1 paper
- Open front: W1015 x D750 x H780mm
- With Doors: W1015 x D770 x H780mm

Y16018	Open Front
Y16020	With Locking Doors



Please note: these 2 items do not use regular Gratnell's trays.

C. A3 paper storage units

- 8 tray size: W495 x D493 x H789mm
- 16 tray size: W970 x D493 x H789mm
- Specify tray colours: any mix of blue, green, red & yellow

Y16010	8 Tray
Y16008	16 Tray

h4 height
789mm

CalStor Art Storage

- Strong, metal framed art trolleys ideal for storing large sheets of paper & other art supplies
- Available with a choice of deep or shallow art trays, art tray / drying rack combination, or drying frame trolley
- Fitted with braked castors
- Dimensions of all units: H947x W500 x D500mm
- Choice of tray colours: Red, Blue, Green or Yellow

Trays available in:

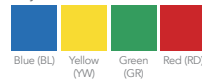

Easy Self Assembly

5 Year
Warranty



D. A3 deep tray trolley

- 6 trays included

Y203400	Cyan
Y203402	Silver



E. Shallow tray art trolley

- Includes 10 trays

Y203404	Cyan
Y203406	Silver



F. Combo trolley

- Includes 5 trays & 10 wire drying racks

Y203408	Cyan
Y203410	Silver



G. Drying trolley

- Includes 20 wire drying racks

Y203412	Cyan
Y203414	Silver

Storage Trolleys

- Mobile metal frame trolleys supplied complete with plastic trays
- Choice of frame colours - please specify



Frame Colours - please specify when ordering



A. Sports trolley

- Perfect for storing PE equipment
- 6 Jumbo Trays
- W1050 x D430 x H1480mm

Y15147



B. Art trolley/snack trolley

- Ideal for storing art & craft resources or brektime snacks or fresh fruit.
- 8 deep trays and lids
- W708 x D430 x H943mm

YEYEF1800



C. Lunchbox trolley

- Large: W1025 x D500 x H900mm
- Small: W610 x D500 x H900mm

YEF8113 Small

YEF8110 Large

Mobile Music Trolleys

- Sturdy attractive units with flexible storage
- Tops have various sized beater holes and a fixed shelf for instrument storage
- Frame colour as shown

Charging Trolley

- Robust locking doors open 270 degrees to fold out of the way
- H790mm to top of unit, total height 957mm
- Specify tray colour: White-WH or Silver-SV

Transporting Trolley

- Metal trolley with large rubber wheels ideal for transporting round the school
- Can hold a range of Grannells tray combinations including the SmartCase & Power Tray



E. Charging trolley

- Height is 790mm to top and 957mm including handle

YP2L102 Power Trolley with 2 x ED Trays

YP2L103 Power Trolley with 3 x Deep Trays

Easy Self Assembly



F. Transporting trolley

- Strap holds trays in place
- Trolley will hold 2 Jumbo trays, or equivalent
- Dimensions H1170 x W560 x D760mm
- Please state tray option & colour required

Y203398

Easy Self Assembly

Page Link - see page

For power trays...

158



Storage Trolleys

- High quality, heavy duty mobile storage trolleys
- All have robust, laminate MDF panels supported by a strong EPC scratch resistant coated metal frame
- Lockable heavy duty castors for easy mobility
- Tested to BS5873 for strength & stability standards
- Supplied flat-packed for easy self-assembly

Extra Value



Page Link - see pages

More metal trolleys...

88



A. 30 lunchbox trolley

- Holds 30 Lunchboxes
- Single unit

YFN0603 W1215 x D600 x H1035mm



B. 60 lunchbox trolley

- Holds 60 lunchboxes
- Double unit

YFN0604 W1215 x D740 x H1160mm



C. Tech2 cloakroom trolley

- 15 double coat/bag hooks per side to hold 30 coats
- Perspex name card-holders for easy location and identification hooks
- Large storage base ideal for shoes & bags with centre divide & lip
- Shelf depth each side 260mm
- Label holder on end panel to identify class etc.

YFN0602 W1610 x D740 x H1140mm

Metal Storage Trolleys

- Robust steel frame trolleys designed to withstand the daily rigours of a busy school environment
- Meet BS5873 safety tests for strength, stability and safety
- Heavy duty castors, 2 lockable
- Blue & silver powder coated (EPC) scratch resistant finish for superior strength
- Supplied flat-packed for easy self assembly



D. Cloakroom trolley

- Large base storage shelf, ideal for shoes & bags with a centre divide
- 15 double coat/bag hooks per side store 30 coats

Y200800 W1200 x D604 x H1115mm



E. Lunchbox trolley

- High capacity trolley with 3 large shelves
- Holds up to 60 lunchboxes

Y200802 W1003 x D610 x H1115mm



5 Year Warranty

CalStor Flexible Storage

- Premium range of tray storage & shelving units
- Robust steel frame with modern styling
- Choice of Silver or Cyan Blue livery
- Fill with any selection of Gragnells tray colours (See page 52 for choice)
- Units can either sit on static feet, or mobile braked castors – supplied with both options
- StopSafe © tray runners prevent trays falling out
- Sizes: Double column units H1025 x W690 x D430mm; Triple column units H1025 x W1020 x D430mm

5 Year
Warranty



Easy Self Assembly



A. 16 shallow tray unit
• Includes 16 shallow trays

Y203420 Cyan Frame
Y203422 Silver Frame



B. 8 deep tray unit
• Includes 8 deep trays

Y203424 Cyan Frame
Y203426 Silver Frame



C. Combination tray unit
• Includes 2 x deep & 4 x ex deep trays

Y203428 Cyan Frame
Y203430 Silver Frame



D. Jumbo tray unit
• Includes 4 jumbo trays

Y203432 Cyan Frame
Y203434 Silver Frame



E. 24 shallow tray unit
• Includes 24 shallow trays

Y203436 Cyan Frame
Y203438 Silver Frame



F. 12 deep tray unit
• Includes 12 deep trays

Y203440 Cyan Frame
Y203442 Silver Frame



G. Triple combi tray unit
• Includes 3x deep & 6 x ex deep trays

Y203444 Cyan Frame
Y203446 Silver Frame



H. 6 jumbo tray unit
• Includes 6 jumbo trays

Y203448 Cyan Frame
Y203450 Silver Frame

HandiStor Mobile & Static Metal Storage

- The HandiStor tray storage range is supplied with both wheels and feet and so can be used either as a mobile trolley, or static frames
- Manufactured with powder coated steel frame with MFC tops
- Supplied c/w Gragnells trays as shown.
- Select your colours from the range shown on page 52
- Choice of single column, double column or triple column widths
- Supplied flat packed for easy self-assembly

Dimensions:

- Depth: All units 420mm
- Width: Treble 1054mm, Double 710mm, Single 370mm
- Height: with feet 850mm, with castors 925mm
- Low units height: with feet 640mm, with castors 715mm

5 Year
Warranty

MFC
Tops



Frame Colours

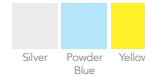

A. Shallow tray, treble width
• 24 shallow trays

Y203500



B. Deep tray, treble width
• 12 deep trays

Y203502



C. Jumbo tray, treble width
• 6 jumbo trays

Y203506



D. Shallow tray, double width
• 16 shallow trays

Y203508



E. Deep tray, double width
• 8 deep trays

Y203510



F. Jumbo tray, double width
• 4 jumbo trays

Y203514



G. Low shallow tray, single width
• 6 shallow trays

Y203516



H. Low shallow tray, double width
• 12 shallow trays

Y203518

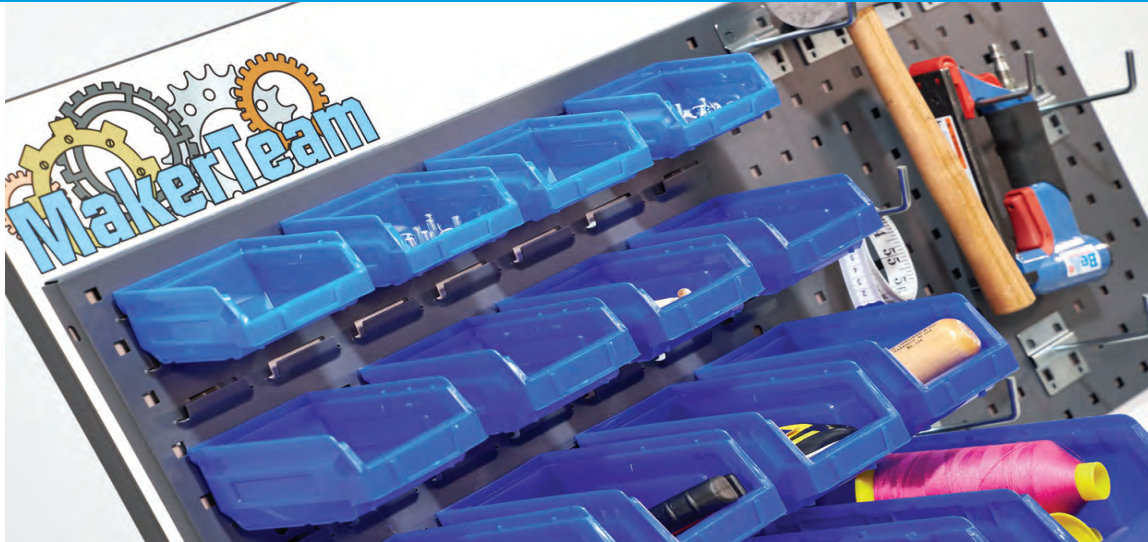

MakerTeam Station Trolley

H1480mm x W1050mm x D460mm



CERTWOOD
Superior quality
CRYSTAL
CLEAR trays.

Heavy duty,
high quality,
locking castors.

Solid whiteboard
back for sharing
design Ideas



Heavy duty,
high quality
bins mounted
on a metal
panel.



Code	MakerTeam Station Trolley	
C77002	H1480mm x W1050mm x D460mm	



**MakerTeam Collaborative
Mobile Whiteboard with Storage**
H1630mm x W1410mm x D650mm

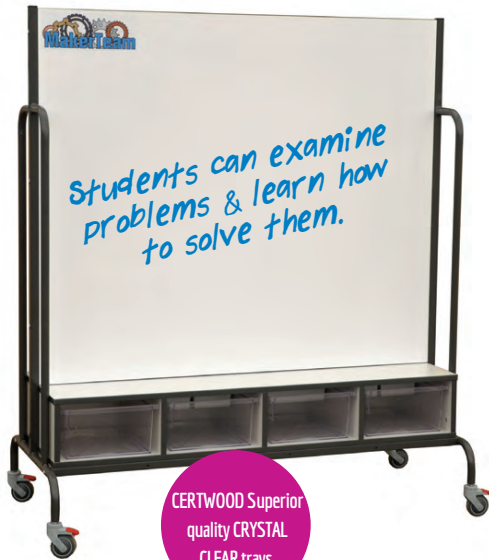

Code	MakerTeam Collaborative Mobile Whiteboard with storage	
C77006	H1630mm x W1410mm x D650mm	

MakerTeam Collaborative Mobile Whiteboard

H1630mm x W1410mm x D650mm



Code	MakerTeam Collaborative Mobile Whiteboard	
C77005	H1630mm x W1410mm x D650mm	



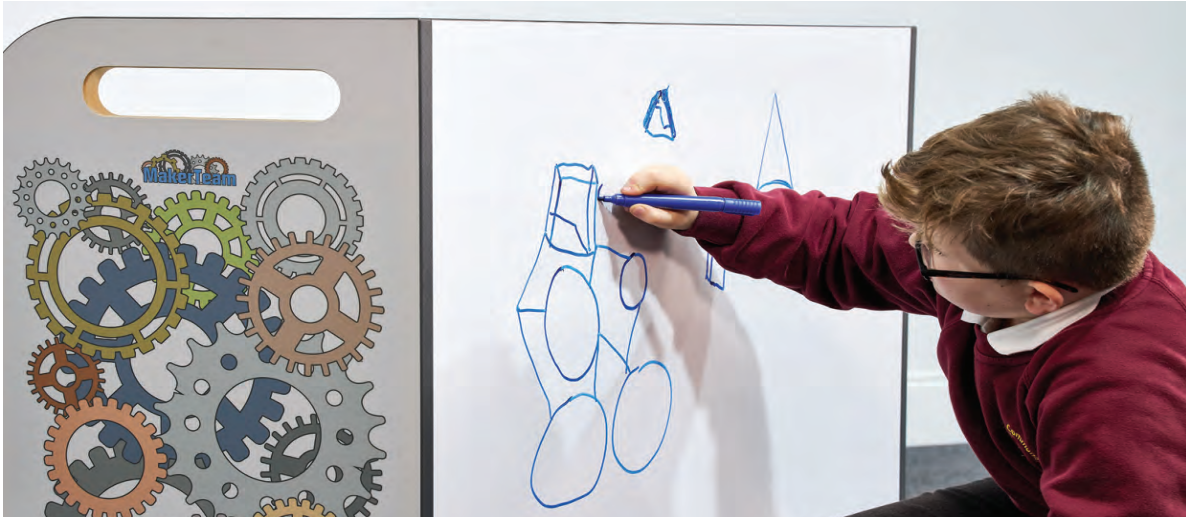

Code	MakerTeam 4 Shelf Trolley	
C77003	H990mm x W1050mm x D460mm	

MakerTeam 4 Shelf Trolley

H990mm x W1050mm x D460mm

Solid
whiteboard
back for sharing
design ideas

Ideal for works
in progress.
Safe & ready for
next lesson.



MakerTeam Double Sided Components Trolley

H990mm x W810mm x D650mm

Heavy duty,
high quality,
locking
castors.

Heavy duty, high quality
bins mounted on a
metal panel on each
side.

Code	MakerTeam D/S Components Trolley	
C77004	H990mm x W810mm x D650mm	



STEM Trolley

- Specialist, silver coloured, steel mobile trolley designed to house plastic trays, tool holders & small part storage bins
- Ideal for STEM and STEAM projects
- Trolley comes c/w 12 shallow trays, 3 deep trays, 12 green small parts bins, roll holder (for tape / ribbon / paper)
- Supplied with 5 single hooks and 5 double hooks
- Cabinet panels are designed to take industrial accessories using the "BOTT" type fixing method
- Supplied flat-packed for easy self-assembly. Please ask for details of our assembly service if needed
- Robust steel frame and heavy duty lockable castors
- Sliding trays, on Stop Safe runners, allow easy access to components



Easy Self Assembly



- Please select shallow & deep tray colours from range on page 52
- Dimensions: H1565 x D1020 x W435mm

Y203550 STEM Trolley each



Parts Bins



Moveable Hooks



Flexible Storage Options



Parts Bins, Roll Holders and Tool Hooks

Science Tray Storage Installations

Please call for a free consultation for your larger projects – full Science Technician store rooms, integrated bench storage etc.

Using the wide range of accessories & fitments will enable you to customise your installation for the maximum benefit.



TecniStor Static Metal Tray Storage

- Static storage systems ideally suited for Science Technician or D&T storage, Print Rooms, Food Tech, or any other areas needing the flexibility of multiple sized compartments, easy retrieval of products or parts, along with the maximising of storage height
- Accommodates all depths of Gratnell's trays – mix available colours to fill the unit as shown
- Options of all tray storage, or a mix of plastic trays & open steel shelves
- Static construction with adjustable feet for stability
- Supplied flat-packed for easy self-assembly
- Full installation service available – please ask for a free site assessment and complete service package quotation
- Dimensions: All units 420mm deep. Single W370, Double w710, Treble W1055mm



Frame Colours

Please specify when ordering



Grey Silver



Easy Self Assembly



A. 51 shallow trays
• H1850

Y203600



B. 9 deep & 18 shallow trays
• H1850
• Includes 6 single shelves

Y203602



C. 3 jumbo, 3 deep & 18 shallow trays
• H1850
• Includes 12 single shelves

Y203604



D. 30 shallow trays
• H1850
• Includes 6 single shelves

Y203606



E. 27 deep Trays
• H1850mm

Y203607



F. Open 4 shelf unit
• H1850mm

Y203608



G. Open 6 shelf unit
• H1850mm

Y203610



H. Shelf/drawer unit
• H1850mm
• 2 wide shelves & 6 wooden drawers

Y203612

TecniStor Static Metal Tray Storage

5 Year
Warranty

Metal
Tops



A. 34 shallow trays
• H1850mm
Y203614



B. 2 deep & 18 shallow tray
• H1850mm
Y203616



C. Open 4 shelf unit
• H1850mm
Y203618



D. 39 shallow trays
• H1500mm
203620

Page Link - see page
For
Gratnell's
trays

50



E. 36 shallow tray
• H1500mm
Y203622



F. 3 x jumbo, 6 x deep, 15 x shallow
• H1500mm
Y203624

Page Link - see page
Metal Tray
Cupboards

361



Frame Colours



Grey

Silver

TecniStor Mobile Metal Trolleys

- Complete trolley sets with metal top built for demanding Science & Technical Environments
- Robust design with industrial style castors and steel top
- Choose bench height 850mm or under bench size 725mm
- Supplied complete with plastic Gragnells Trays – select from the range on page 52
- Optional steel shelf trolleys suit larger items
- Range of accessories available to fit – please ask for details
- Static frames also available – please enquire for details

5 Year
Warranty



Frame Colours
Please specify when ordering



Grey Silver



Durable
Metal Tops



Easy Self Assembly



A. 3 column tray unit
• W1055 x D420mm

Y203640 H850mm, 18 Tray
Y203642 H725mm, 15 Tray



B. 2 column tray unit
• W710 x D420mm

Y203644 H850mm, 12 Tray
Y203646 H725mm, 10 Tray



C. 1 column tray unit
• W370 x D420mm

Y203648 H850mm, 6 Tray
Y203650 H710mm, A3 Art Trolley

TecniStor Static Low Storage Units

- Static units ideal for use under existing benching
- Sold without metal top – this can be ordered separately.
- Supplied c/w Gragnells trays – select any mix from page 52
- Also available as steel shelf units – ideal for larger items



D. 3 column static tray unit
• W1055 x D420mm

Y203652 H825mm, 21 Tray
Y203654 H725mm, 18 Tray



E. 2 column static tray unit
• W710 x D420mm

Y203656 H825mm, 14 Tray
Y203658 H725 mm, 12 Tray



F. 1 column static tray unit
• W370 x D420mm

Y203660 H825mm, 7 Tray



OneStore Teaching Wall 2.0

The OneStore is our flagship Teaching Wall. Designed for teachers and their classrooms. The OneStore creates an ordered room with efficient storage space, ideal to keep students focused and minimise distractions. Modular in its assembly, this teaching wall can be made into any configuration that fits the needs of the area or teacher. The OneStore 2.0 features 48 Gratnells storage trays in a choice of colours, along with generous cupboard and shelving storage. By having everything conveniently stored away, the learning environment is free from distractions. The centre of this teaching wall is the

interactive whiteboards. With the screen fitted in the middle of the teaching wall, it gives students a clear focal point.

The OneStore 2.0 includes 2 sliding whiteboard doors which can be used for writing and teaching. The whiteboard doors are soft closing, features aluminium handles on each side and use an aluminium track system.

A teachers desk is incorporated into the design with a removable back panel inside a low cupboard for easy access to data and power ports. Available in a choice of 5 colours and made from 18mm solid MDF. All with a 10 year guarantee.

Classroom Storage



Installation is available for the OneStore Teaching Wall 2.0 and is advised. The installation process takes approximately one day per Teaching Wall for completion and is carried out by one of our own installation craftsmen. However, if you would prefer to install the Teaching Wall yourself, then please do not order the installation and we will supply assembly instructions for the OneStore. Please call us to discuss bespoke sizes and colour requirements.



The OneStore 2.0 includes two sliding whiteboard doors for teaching and display. The doors are mounted using a sleek and strong metal sliding runner system. Doors feature soft closing stops for ease of use and avoid any finger trapping. This sliding door system allows the doors to run smoothly and freely with little resistance.

Code	OneStore Teaching Wall - Non-Locking	
B76057	H2100mm x W4000mm D480mm	
Code	OneStore Teaching Wall - Locking	
B76058	H2100mm x W4000mm D480mm	

Installation (if required) Approximately one day per OneStore

Code	Installation (if required)	
B76037	Approximately one day incl. travelling	

Please confirm this before ordering as this may vary depending on your location.



Classroom Storage



The standard option for the OneStore 1.0 comes in two sizes, 4 metres and 5 metres wide. Bespoke sizes can also be easily made, please contact us to discuss your requirements. A teachers desk is incorporated into the design with a removable back panel for easy access to data and power ports, a pull out keyboard desk, additional cupboard storage and 9 acrylic pigeonhole spaces. Supplied with 2 sliding soft close, whiteboard doors, 48 shallow Gratnells trays and a generous configuration of cupboard storage with optional locks. Available in a choice of 5 colours and made from 18mm solid MDF. All with a 10 year guarantee.

Call us to discuss bespoke sizes and colour requirements.



4 Metres Wide

Code	OneStore Teaching Wall - Non-Locking	
B76033	H2100mm x W4000mm D600mm	
Code	OneStore Teaching Wall - Locking	
B76034	H2100mm x W4000mm D600mm	



5 Metres Wide

Code	OneStore Teaching Wall - Non-Locking	
B76035	H2100mm x W5000mm D600mm	
Code	OneStore Teaching Wall - Locking	
B76036	H2100mm x W5000mm D600mm	

Installation (if required) - Approximately one day ✓

Code	Installation (if required)	
B76037	Approximately one day incl. travelling	

Please confirm this before ordering as this may vary depending on your location.

Code	Low Storage Wall - 4.5m Wide - Shown above	
B76065	H2000mm x W4500mm D480mm	
Code	Low Storage Wall - 3.5m Wide	
B76066	H2000mm x W3500mm D480mm	

Our Low Storage Wall is an easy way to instantly organise your classroom and makes the most of your space. Featuring two open display bookcases, tray and cupboard storage and open low storage. You'll find a place for everything in this cost effective storage wall. Your classroom smartboard in the space between the bookcases direct onto the wall. Made from 18mm solid wood MDF with bump resistant edging. Available in two widths, 3.5m and 4.5m and a choice of 5 colour finishes. Comes with a 5 year guarantee.

Installation (if required) - Approximately one day

Code	Installation (if required)	
B76037	Approximately one day incl. travelling	

Please confirm this before ordering as this may vary depending on your location.

Low Storage Wall



Learning & Storage Walls

These Learning Walls not only provide a strong focal point for classroom environments, it also provides exceptional, dedicated storage that renovates classrooms into stylish, attractive spaces. These premium units are manufactured in a high quality 18mm maple, beech, white, grey or oak.

Three options are available:

1. Learning Wall
2. Storage Wall
3. Cupboard Wall



Improve your Teaching Environment



from this to this!



UK Manufactured



The Learning Wall

Overall Dimensions: H2100mm x W4080mm x D480mm

The Learning Wall is a classroom essential. With the focal point being the centre area for your intereractive whiteboard. This area measures 1250mm high by 2000mm wide & has a solid back to make sure your smartboards are secured safely. Special sizes are also not a problem, please call to discuss your requirements.

This Learning Wall also includes five double cupboards, an open workstation space & 2 tray units including 48 Gratnells tray in a choice of colours - trays can also be substituted for Deep, Extra Deep or Jumbo trays.

Locking doors available as optional extra.

The Learning Wall	
A76005	

The Learning Wall with Locking Doors	
A76006	



The Storage Wall

Overall Dimensions: H2100mm x W4080mm x D480mm

Choice of colour finishes



Locking doors available as optional extra.

The Storage Wall	The Storage Wall with Locking Doors
A76001	A76002

The Storage Wall provides a variety of storage solutions & includes 4 top cupboards, two middle cupboards & two floor standing tray units. The Storage Wall has 24 Gratnells Deep trays & 48 Gratnells Shallow tray in a choice of colours - trays can also be swapped for Deep, Extra Deep or Jumbo.

Special sizes are not a problem. Call to discuss your requirements

Please phone for details and prices

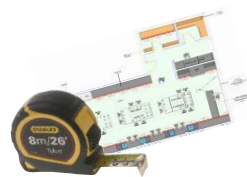

Choice of Gratnells Tray Colours



The Cupboard Wall

Overall Dimensions: H2100mm x W4080mm x D480mm

Choice of colour finishes



Locking doors available as optional extra.

The Cupboard Wall	
A76003	

The Cupboard Wall with Locks	
A76004	

The Cupboard Wall provides the ideal storage solution. There are 4 top cupboards, 4 middle cupboards & 4 floor cupboards.





Are you stimulating those young minds?
Strong, attractive furniture with a friendly & fulfilling approach promotes creativity from day one!



SPACES TAYLORED

Early Years

Introduction to the NEW Creative! Early Years Range	99-100
Creative! Role Play Panels	101-102
Creative! Role Play Furniture	103
Creative! Storage Solutions	104-109
Creative! Tables & Chairs	110-112
Soft Seating	113-116
Cushions & Mats	117-120
Sand & Water Play	121
Easels	122
Play Corners & Modules	123-124
Natural Beech Storage Unit	125-126
Tables & Chairs	127-128
Outdoor Play Furniture	129-131

[Main Content Page](#)

Early Years

Here we present a range of products that provide a safe, comfortable and colourful environment, where children enjoy a world they recognise and where their imaginations are inspired.

We can provide children with somewhere to sit and learn alone and spaces to be taught in groups.

Our products provide children stimulation through use and display. Our storage facilities ensure that their daily world is left neat and tidy.

Cloakroom and lunch storage facilities teach young minds to guard and value their personal space and possessions.



Introducing Creative! Early Years Range

The Creative! furniture range has been created to offer a complete range of matching premium products which represent the very best in quality, safety and value.

We understand the requirements of a productive early years environment: children need a secure, safe, nurturing environment within which they can explore, learn and grow. This range has been designed with all of that in mind.



Manufactured in the UK from Premium grade maple melamine. Provides a hard - wearing, scratch resistant, easy clean surface that can be cleaned with anti-bacterial sprays



There is no complicated method involved when joining this furniture together. Products simply butt together, providing the flexibility to quickly and easily re-configure your learning space and create 'zones' when needed, keeping those young eager minds stimulated and busy!



We offer a free and comprehensive 3D room design service for your space. Let us take the hassle out of your project for you, simply give us a call to discuss or arrange a site visit from a member of our sales team. We can assist with any size project from a small room to an entire school. We are here to help!



Creative! Natural Role Play Panels

- Made from maple melamine with a solid beech timber frame and tough, child safe, clear lacquer finish
- Easy Clean Surfaces
- Each panel: W780 x D40 x H1200mm (supplied with 2 joining blocks)
- Lockable joining blocks allow panels to join to each other at seven different angles, enabling you to create any shape to meet your needs and make the most of the available space
- 5 year warranty



A. Display Panel

- Double-sided sound reducing Velcro display board

YCRT0320



B. Double Door Panel

- Double doors with cut-out detail

YCRT0321



C. Maple Panel

- Plain panel for dividing space

YCRT0322



D. Tall Archway Panel

- Open archway for easy access
- H1310mm

YCRT0323



E. Whiteboard Panel

- Double-sided whiteboard

YCRT0324



F. Window Panel

- Window panel with washable curtains

YCRT0325



G. Maple Counter Panel

- Two shelves, awning and counter

YCRT0326



H. Mirror Panel

- Single safety mirror, maple back

YCRT0327



I. Chalkboard Panel

- Double-sided chalkboard

YCRT0328



Creative! Panel Connectors

For complete flexibility when setting out your room, our Panel Connectors allow you to join your panels (at any angle) to walls and other Creative! furniture. This unique system allows you to create secure room divisions, and use a combination of storage units and panels, to create defined areas for role play, crafts, construction, reading and so much more.



J. Connectors - Set of 2

- Includes two brackets to connect one panel to furniture or a wall at any angle
- Fits all Play Panels

YCRT0329

Creative! Coloured Role Play Panels

- Creative! colourful role play panels which can be used alongside the maple panel range to create themes or divide space
- Made from solid beech timber and birch plywood with a tough, child safe, clear lacquer finish
- Lockable joining blocks allow panels to join to each other at seven different angles, enabling you to create any shape to meet your needs
- Each panel: W780 x D40 x H1200mm (supplied with 2 joining blocks)



A. Garage Panel
• Pump, chalkboard and counter

YCRT0334



B. Bank/Post Office Panel
• Counter, shelf, ATM and cut-outs

YCRT0336



C. Counter Panel
• Two shelves, awning and counter

YCRT0332



D. Window Panel
• Flower detail and fabric curtains

YCRT0333



E. No.10 Door Panel
• Door, letterbox, and engraved detail

YCRT0335



F. Health Centre Panel
• Counter, window chalkboard and shelf

YCRT0338



G. Theatre Panel
• Chalkboard and fabric curtains

YCRT0337



Mix & Match panels on these pages combine to give endless possibilities for creative play



Creative! Kitchen Role Play Units

- Anti finger-trap hinges - ideal for group play
- Maple wood grain finish
- 600mm worktop height - perfect for 3 years+
- Hard-wearing, scratch resistant, wipe clean melamine surfaces
- Rotating dials
- 5 minute assembly
- Kitchen Set: W1600 x D360 x H830mm
- Units: W400 x D360 x H630mm (Microwave: W400 x D260 x H200mm)



A. Mobile Market

- Includes 4 wooden crates
- Removable double-sided chalkboard
- Lockable castors
- W1200 x D420 x H1300mm

YCRT0351



B. Roll Unfold Kitchen - Large

- 5 in 1 unit: hob, oven, ironing board, sink & washer
- Rotating dials and tap
- Folds away for easy storage when not in use
- Integrated wheel for mobility when folded
- W1720 x D460 x H600mm
- Folded: W760mm

YCRT0349



Unit Folded



Safety Feature – anti finger trap hinges on all units



C. Washing machine

YCRT0343	Maple
YCRT0344	Red



Complete Kitchen Set

YCRTKSET-M	Maple
YCRTKSET-R	Red



D. Oven/hob unit

YCRT0345	Maple
YCRT0346	Red



E. Fridge

YCRT0341	Maple
YCRT0342	Red



F. Sink/dishwasher unit

YCRT0339	Maple
YCRT0340	Red



G. Microwave

YCRT0347	Maple
YCRT0348	Red

Creative! Low Level Storage Units

- The perfect height for creating an enabling environment which encourages independence and exploratory play.



A. Static Low Level Unit

- Resources accessible from both sides
- Anti-scratch, low noise, lockable castors
- Sturdy construction
- W900 x D400 x H430mm
- Top shelf: H320mm

YCRT0101 With Clear Tubs
YCRT0102 With Baskets



B. Mobile Low Level Unit

- Resources accessible from both sides
- Sturdy construction
- W900 x D400 x H430mm
- Top shelf: H320mm

YCRT0103 With Tubs
YCRT0104 With Baskets



C. Low Mirror Play Unit

- Removable safety mirror surface
- Top ledges create enclosed play area
- Resources accessible from both sides
- W900 x D400 x H430mm
- Top shelf: H320mm

YCRT0105 With Tubs
YCRT0106 With Baskets



Sliding wooden dividers



D. Clear View Low Browser

- Two movable dividers allow you to condense or expand the storage compartments
- Super tough clear sides
- Rounded solid beech grab rails (H310mm)
- W900 x D400 x H360mm

YCRT0107



E. Kinder Box

- Storage unit with 4 compartments
- Compartments 288 x 260mm
- Anti-scratch, low noise, lockable castors
- W615 x D595 x H350mm

YCRT0108



F. Low Level 90° Corner Unit

- Join two units in a smooth curve
- Use 4 corners to create an island
- Ideal for safe free-flow areas
- W500 x D500 x H430mm
- Top shelf: H320mm

YCRT0110



G. Easy Access Storage Unit

- Two fixed dividers
- Large safety mirror side
- Ideal for storing blocks for easy access
- W900 x D400 x H430mm

YCRT0109



Removable safety surface mirror

Creative! Low Level Display & Store Units

- These low level display units with add-ons, perfectly combine storage with a useful divider feature
- The display and whiteboard dividers are ideal for displaying work and information, whilst the mirror divider is perfect for sensory use and play
- All divider panels are double-sided.



A. Low Display Storage Unit

- Removable double-sided Velcro display board
- Resources accessible from both sides
- Anti-scratch, low noise, lockable castors
- W900 x D400 x H800mm - Top shelf: H320mm

YCRT0111 With Castors & 3 clear tubs

YCRT0112 With Castors & baskets

YCRT0113 Without Castors & 3 clear tubs

YCRT0114 Without Castors & baskets



B. Low Mirror Storage Unit

- Removable double-sided safety mirror
- Resources accessible from both sides
- Anti-scratch, low noise, lockable castors
- W900 x D400 x H800mm - Top shelf: H320mm

YCRT0115 With Castors & 3 clear tubs

YCRT0116 With Castors & baskets

YCRT0117 Without Castors & 3 clear tubs

YCRT0118 Without Castors & baskets



C. Low Magnetic Storage Unit

- Removable double-sided white enamelled steel for use with magnets
- Resources accessible from both sides
- Anti-scratch, low noise, lockable castors
- W900 x D400 x H800mm - Top shelf: H320mm

YCRT0119 With Castors & 3 clear tubs

YCRT0120 With Castors & baskets

YCRT0121 Without Castors & 3 clear tubs

YCRT0122 Without Castors & baskets

Creative! Medium Height Open Storage Units

From practical storage solutions to play themed units, Creative! is a comprehensive and coordinated range that will suit all environments and budgets. These medium height storage units represent excellent quality combined with flexibility.



D. Sweeping 45° Storage Unit

- Storage unit with 3 shelves
- Resources accessible from both sides
- No dividers for added versatility
- Use two or more to make a curve or 'S' shape
- W900 x D455 x H660mm - Top shelf: H560mm

YCRT0123



E. Open Storage Unit

- Resources accessible from both sides
- No dividers for added versatility
- W900 x D400 x H660mm
- Top shelf: H560mm

YCRT0124



F. 90° Corner Unit

- Join two tall units in a smooth curve
- Use four corners to create an island
- W500 x D500 x H660mm
- Top shelf: H560mm

YCRT0125

Creative! Medium Height Display & Store Units



Mirror Back

A. Storage Unit with Display/Mirror Back

- Storage unit with choice of tubs or baskets
- Velcro display surface on reverse
- Removable mirror attaches to Velcro on reverse
- Mobile unit has anti-scratch, low noise, lockable castors
- W900 x D400 x H660mm - Top shelf: H560mm

YCRT0129 Mobile, with 6 Clear Tubs

YCRT0130 Mobile, with 6 baskets

YCRT0137 Static with 6 Clear Tubs

YCRT0138 Static with 6 baskets



Rear View

B. Storage Unit with Display Top Panel

- Velcro display surface on reverse
- Removable mirror attaches to Velcro on reverse
- Top add-ons can be easily removed and interchanged
- Anti-scratch, low noise, lockable castors
- W900 x D400 x H1040mm
- Top shelf: H560mm

YCRT0134 With 6 Clear Tubs

YCRT0135 With 6 baskets



C. Lockable Storage Cupboard with Display/Mirror Back

- 2 door, lockable storage cupboard
- 3 shelves of which 2 are height adjustable
- Velcro display surface on reverse
- Removable mirror attaches to Velcro on reverse
- Made from maple melamine
- W900 x D400 x H900mm
- Top shelf: H800mm

YCRT0147



D. Extra Wide Open Storage Unit

- Extra wide unit for storing larger items
- Ideal for storing wooden blocks
- Resources accessible from both sides
- W1200 x D400 x H660mm - Top shelf: H560mm

YCRT0136



E. Extra Wide Storage Unit with Back

- Extra wide unit for storing larger items
- Velcro display surface on reverse
- Removable mirror attaches to Velcro on reverse
- W1200 x D400 x H660mm
- Top shelf: H560mm

YCRT0139



F. Mobile Clear View Browser/Storage Unit

- 2 movable dividers & super tough clear sides
- Anti-scratch, low noise, lockable castors
- W900 x D400 x H660mm

YCRT0131 Storage space on lower level

YCRT0132 With 6 Clear Tubs

YCRT0133 With 6 baskets



G. Mobile Storage Unit with Dressing up Add-on

- Dressing up add-on with hanging rail
- Anti-scratch, low noise, lockable castors
- Resources accessible from both sides
- W900 x D400 x H1180mm - Top shelf: H320mm

YCRT0148 With 3 Clear Tubs

YCRT0149 With 3 baskets



H. Mobile Storage Unit with Theatre Add-on

- Theatre add-on with washable fabric curtains (choice of Purple or Taupe Curtains)
- Anti-scratch, low noise, lockable castors
- Velcro display surface on reverse
- Removable mirror attaches to Velcro on reverse
- W900 x D400 x H1370mm - Top shelf: H560mm

YCRT0150 With 6 Clear Tubs

YCRT0151 With 6 baskets



I. Mobile Unit with Shop Canopy Add-on

- Shop canopy with washable fabric awning
- Anti-scratch, low noise, lockable castors
- Velcro display surface on reverse
- Removable mirror attaches to Velcro on reverse
- W900 x D400 x H1040mm - Top shelf: H560mm

YCRT0152 With 6 Clear Tubs

YCRT0153 With 6 baskets



Creative! Book Storage & Display Units



- A. Large Access Shelf Unit**
- Velcro display surface on reverse
 - Removable mirror attaches to Velcro on reverse
 - W1200 x D400 x H1000mm - Top shelf: H720mm

YCRT0141



- B. Mobile Tall Storage Unit**
- Holds 9 clear tubs or baskets
 - Maximises storage
 - Anti-scratch, low noise, lockable castors
 - W900 x D400 x H900mm - Top shelf: H800mm

YCRT0142 With 9 Clear Tub
YCRT0143 With 9 baskets



- C. Large Double-sided Trolley**
- Double-sided unit
 - Holds up to 30 small baskets (sold separately)
 - Anti-scratch, low noise, lockable castors
 - W1000 x D500 x H1000mm - Top shelf: H720mm

YCRT0144



- D. Large Book Display Unit**
- Larger height & width gives more room for books
 - Storage at back for tall books & additional shelf
 - Four large book display shelves
 - Baskets not included (sold separately)
 - W1200 x D400 x H1000mm - Top shelf: H770mm

YCRT0145



- E. Mobile Double-sided Book Display**
- Made from premium maple melamine
 - 2 large book display shelves on either side
 - Lower level storage shelf
 - Anti-scratch, low noise, lockable castors
 - Baskets not included (sold separately)
 - W900 x D400 x H800mm

YCRT0146



- F. Double-sided Book Display Unit**
- Two large accessible book display shelves
 - Storage at back for tall books
 - W900 x D400 x H660mm

YCRT0140



- G. Mobile Tall Book Display**
- Four large book display shelves
 - Storage at back for tall books & extra shelf
 - Anti-scratch, low noise, lockable castors
 - Sturdy construction

YCRT0126 W900 x D400 x H800mm



- H. Mobile Double-sided Trolley**
- Double-sided unit
 - Anti-scratch, low noise, lockable castors
 - W900 x D400 x H800mm
 - Top shelf: H560mm

YCRT0127



- I. Mobile Trolley with Display & Mirror Back**
- Mobile unit with 3 shelves
 - Anti-scratch, low noise, lockable castors
 - Velcro display surface on reverse
 - Removable mirror attaches to Velcro on reverse
 - W900 x D400 x H800mm - Top shelf: H560mm

YCRT0128

Creative! Medium Height Display Tray Units

Designed to fully coordinate with the Creative! range, our tray storage units are made from a premium MDF core with clear lacquered edges. Units are designed with flexible runners to house different depths of trays - maximising storage options and allowing units to be easily reconfigured. The reverse of each unit features a loop nylon Velcro fabric that can be used for display and provides a more tactile surface for young children. Tray units benefit from:

- Runners which accommodate all Grattells tray types: Shallow, Deep, Extra Deep and Jumbo
- Heavy duty lockable furniture castors with low noise, anti-scratch wheels
- Creative! panel connector compatibility
- Loop nylon Velcro fabric on reverse of unit, which can be used to display work, projects etc



A. Tray Storage Unit (730mm height)

- 1 column tray storage unit suitable for shallow and deep trays
- Please specify tray colour when ordering
- Anti-scratch, low noise, lockable castors
- Velcro display surface on reverse
- W360 x D465 x H730mm

YCRT0154 3 Deep Trays

YCRT0155 2 shallow and 2 deep trays

YCRT0156 6 shallow trays



B. Tray Storage Unit (730mm height)

- 2 column tray storage unit suitable for shallow and deep trays
- Please specify tray colour when ordering
- Anti-scratch, low noise, lockable castors
- Velcro display surface on reverse
- W700 x D465 x H730mm

YCRT0157 6 Deep Trays

YCRT0158 4 shallow & 4 deep trays

YCRT0159 12 shallow trays



C. Tray Storage Unit (730mm height)

- 3 column tray storage unit suitable for shallow and deep trays
- Please specify tray colour when ordering
- Anti-scratch, low noise, lockable castors
- Velcro display surface on reverse
- W1045 x D465 x H730mm

YCRT0160 9 deep Trays

YCRT0161 6 shallow & 6 deep trays

YCRT0162 18 shallow trays



D. 2 Column Shelf Storage

- Storage unit with space for 4 jumbo size trays
- Anti-scratch, low noise, lockable castors
- Velcro display surface on reverse
- Please specify tray colour when ordering
- W700 x D465 x H900mm

YCRT0163 No Trays

YCRT0164 4 Jumbo Trays



E. Welsh Dresser Display Storage

- Storage unit with choice of tubs or baskets
- Velcro display surface on reverse
- W900 x D400 x H1260mm

Y 6 Clear Tubs

Y 6 Baskets



F. 4 Column Shelf Storage

- Storage unit with space for 8 jumbo size trays
- Anti-scratch, low noise, lockable castors
- Velcro display surface on reverse
- Please specify tray colour when ordering
- W1386 x D465 x H900mm

YCRT0167 No Trays

YCRT0168 8 Jumbo Trays



G. Low Level Circular Storage Unit

- Perfect centre piece for any room
- Anti-scratch, low noise, lockable castors
- Ideal height for play surface
- W890 x D890 x H540mm

YCRT0171 8 clear curved trays

YCRT0172 8 curved baskets



H. High Level Circular Storage Unit

- Perfect centre piece for any room
- Anti-scratch, low noise, lockable castors
- W890 x D890 x H770mm

YCRT0169 12 clear curved trays

YCRT0170 12 curved baskets



Solid Tray Colours



Green Blue Yellow Red

Translucent Tray Colours



Lemon Kiwi Blueberry Grape Clear



A. Tray Storage Unit (900mm height)

- 3 column tray storage unit suitable for shallow and deep trays
- Please specify tray colour when ordering
- Anti-scratch, low noise, lockable castors
- Velcro display surface on reverse
- W1045 x D465 x H900mm

YCRT0173	12 Deep Trays
YCRT0174	6 shallow and 9 deep trays
YCRT0175	24 shallow trays



B. Tray Storage Unit (1080mm height)

- 3 column tray storage unit suitable for shallow and deep trays
- Please specify tray colour when ordering
- Anti-scratch, low noise, lockable castors
- Velcro display surface on reverse
- W1045 x D465 x H1080mm

YCRT0176	15 Deep Trays
YCRT0177	6 shallow and 12 deep trays
YCRT0178	30 shallow trays



C. Tilt Tote Storage (660 x 900mm)

- Inclined for easier access
- Anti-scratch, low noise, lockable castors
- Tub/basket height 190mm (deep)
- W900 x D400 x H660mm

YCRT0179	6 Clear Tubs
YCRT0180	6 Baskets



D. Tilt Tote Storage (800 x 900mm)

- Inclined for easier access
- Anti-scratch, low noise, lockable castors
- Tub/basket height 120mm (shallow)
- W900 x D400 x H800mm

YCRT0181	9 Clear Tubs
YCRT0182	9 baskets



E. Tilt Tote Storage (800 x 1190mm)

- Inclined for easier access
- Anti-scratch, low noise, lockable castors
- Tub/basket height 120mm (shallow)
- W1190 x D400 x H800mm

YCRT0183	12 Clear Tubs
YCRT0184	12 baskets



F. Tilt Tote Double-sided Storage

- Inclined for easier access
- Anti-scratch, low noise, lockable castors
- Tub/basket height 120mm (shallow)
- W900 x D800 x H800mm

YCRT0185	18 Clear Tubs
YCRT0186	18 baskets



G. Stepped Storage Right Hand

- Great for presentation
- W950 x D400 x H900mm

YCRT0187	6 Clear Tubs
YCRT0188	6 Baskets



H. Stepped Storage Left Hand

- Great for presentation
- W950 x D400 x H900mm

YCRT0189	6 Clear Tubs
YCRT0190	6 Baskets



I. Plan Chest

- 6 drawer plan chest, takes A1 paper
- Made from durable, hard-wearing, maple melamine
- High quality runners for smooth operation
- W1015 x D710 x H800mm

YCRT0191	
----------	--

Creative! Wooden Tables & Chairs

- All Tables have a solid beech frame with a maple melamine top which is easy to clean, hygienic and scratch resistant
- Rounded corners for classroom safety
- Solid Beech legs ensure stability
- Available in a variety of height options to accommodate all ages
- All Tables and Chairs BS EN 1729 Compliant



A. Pack of 4 Beech Stacking Chairs

- Supportive, curved backrest
- Beech & plywood construction
- BS EN 1729 compliant

	Seat Height	For Table Height
YCRT0436	210	400
YCRT0437	260	460
YCRT0438	310	530
YCRT0439	350	590



B. Square Table

YCRT0402	W695 x D695 x H400mm
YCRT0403	W695 x D695 x H460mm
YCRT0404	W695 x D695 x H530mm
YCRT0405	W695 x D695 x H590mm



C. Creative! Small Round Table

- W500 x D500 x H320mm

YCRT0304



D. Small Rectangular Table

YCRT0407	W960 x D695 x H400mm	£148.82
YCRT0408	W960 x D695 x H460mm	£148.82
YCRT0409	W960 x D695 x H530mm	£148.82
YCRT0410	W960 x D695 x H590mm	£148.82



E. Rectangular Table

YCRT0412	W1120 x D560 x H400mm	£158.47
YCRT0413	W1120 x D560 x H460mm	£158.47
YCRT0414	W1120 x D560 x H530mm	£158.47
YCRT0415	W1120 x D560 x H590mm	£158.47



F. Large Rectangular Table

YCRT0417	W1500 x D695 x H400mm	£184.44
YCRT0418	W1500 x D695 x H460mm	£184.44
YCRT0419	W1500 x D695 x H530mm	£184.44
YCRT0420	W1500 x D695 x H590mm	£184.44



G. Circular Table

YCRT0422	Dia. 1000mm x H400mm
YCRT0423	Dia. 1000mm x H460mm
YCRT0424	Dia. 1000mm x H530mm
YCRT0425	Dia. 1000mm x H590mm



H. Trapezoid Table

YCRT0427	W1120 x D560 x H400mm
YCRT0428	W1120 x D560 x H460mm
YCRT0429	W1120 x D560 x H530mm
YCRT0430	W1120 x D560 x H590mm



I. Semi Circle Table

YCRT0432	W1630 x D560 x H400mm
YCRT0433	W1630 x D560 x H460mm
YCRT0434	W1630 x D560 x H530mm
YCRT0435	W1630 x D560 x H590mm



A. Baby Changing Unit with Steps

A versatile, stable and sturdy baby changing unit with anti-slip steps to assist toddlers in getting to the top without the need for lifting. When not in use, the steps simply slide into the underside of the changing unit.

- Spacious, lockable cupboard
- Two height adjustable shelves
- Large changing surface with high sides for comfort and safety
- Includes a Wipe clean changing mat
- Anti-slip treads on steps

YCRT0193 W1100 x D610 x H910mm



B. Baby Changing Unit

Mobile baby changing unit with two spacious storage shelves and high quality lockable castors. Sturdy maple melamine construction with rounded, lacquered edges.

- Lockable castors for easy mobility
- Hygienic wipe clean melamine surfaces
- Includes wipe clean changing mat

YCRT0192 W830 x D610 x H880mm



C. Mobile Dressing Up Unit

- Suitable for 3 years+
- 6 coat hooks on each side
- Full length safety mirror
- Handy storage compartment at top of unit
- Storage area in base of trolley
- Supplied with 3 clear tubs for visible storage
- Anti-scratch, low noise, lockable castors

YCRT0195 W1000 x D400 x H1100mm



10 Year Guarantee

D. 2-in-1 Art Easel and Storage Trolley

- Double-sided 2-in-1 art easel and storage trolley
 - One side Drywipe and one side chalkboard
- Wipe clean maple melamine construction
- Anti-scratch, low noise, lockable castors
- Provides useful arts and crafts storage with an upper easel making this a compact, versatile art station for any classroom!
- Includes 8 clear paint pots and 4 shallow tubs
- Space for storage in centre of unit
- Features paper clip on each easel

YCRT0202



E. Early Years Computer Station

- Storage unit with rear compartment for PC
- Made from high quality maple melamine
- Pre-school size
- Work surface height 530mm
- Recommended chair height H310mm

YCRT0194 W950 x D590 x H630mm



F. Drying Rack

- 10 adjustable drying racks fit up to A2 paper
- Holds up to 20 racks (10 sold separately)
- Racks are fully removable for easy cleaning
- Wipe clean hard-wearing melamine surfaces
- Anti-scratch, low noise, lockable castors

YCRT0200 W710 x D510 x H1085mm



G. Double-sided Art Resource Unit

- Supplied with 3 clear tubs and 4 clear paint pots
- Pot holders and storage on top for additional pots
- Small shelves for baskets or resources
- Ribbon reel holder
- Anti-scratch, low noise, lockable castors

YCRT0201 W900 x D400 x H800mm

A. Tall Den Cave Set

- Includes two open storage units and the den cave roof add-on
- Baskets available separately
- W2250 x D900 x H1400mm
- Play Space: W1450 x D900 x H1400mm

YCRT0203 Blue Roof

YCRT0204 Brown Roof



B. Indoor/Outdoor Folding Den & Canopy

- Unique folding mechanism, easy to assemble and move between rooms, indoors or outdoors as required
- Endless possibilities – this Den can be decorated to match any theme
- Made from high quality, durable birch plywood
- Suitable for both indoor and outdoor use (must be stored indoors)
- Rounded corners and lacquered safety edges
- Available with a range of accessory options – see below

YCRT0207 W1700x D1120x H1160mm



C. Camouflage Den Accessory kit

- Ideal for outdoor use as a secret hideaway
- High Quality washable camouflage fabric top cover
- 4 x Camouflage side net curtains
- Fabric cover has easy access openings at the front and back
- Splash proof wipe clean Lime Green floor mat

YDKIT0C



D. Rainbow Den Accessory Set

- 3 x sensory mesh drapes (Red, Blue and green)
- 3 x Cushions (Red, Orange and Yellow)
- Large Bolster cushion (multi-coloured)
- Splash proof and wipe clean lime green floor mat

YDKITR



E. Blackout Sensory Den Kit

- Ideal for sensory play areas and quiet spaces
- High Quality washable blackout fabric cover
- Fabric cover has easy access openings at the front and back
- Splash proof wipe clean black floor mat

YDKITB0



A

Wide choice of Just Vinyl or fabric options



B

Best Seller



C

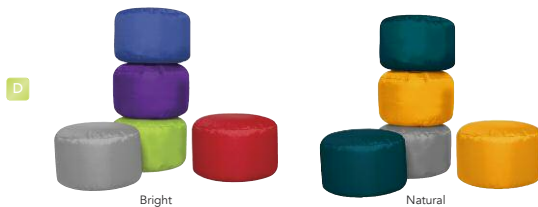

D

Bright

Natural

Soft Seating

A. Quilted tub chair & sofa

- Eye-catching tub chairs and 2-seater sofas upholstered in wipe clean vinyl
- Colours: Red, Green, Blue*
- Chair dimensions: W470 x D460 x H495mm
- Sofa dimensions: W910 x D460 x H495mm

YQTC	Chair
YQTS	Sofa

* Please specify colour

B. Toad Stool children's seats

Fun, funky, bright, colourful – great for classroom breakout areas, even better for library and play spaces.

- White vinyl base and spots. Dimensions height 650mm, chair is W600mm, 2-seater W1000mm
- Different colour tops available

Y310240	Toad Stool
Y310242	Toad Stool 3pk

C. Easy junior seating

- Modular child size soft seating
- Can be ordered as single units, or why not combine to make a cosy reading corner?
- Available in Just colour vinyl or any fabric from the Advantage range
- Dimensions: D480mm, seat height 310mm

Y310206	Single Chair W405mm	each
Y310208	2 Seater W810mm	each
Y310210	3 Seater W1215mm	each
Y310212	Corner Unit W770mm	each
Y310214	Armchair	each
Y310216	LH Arm Chair	each
Y310218	RH Arm Chair	each
Y310220	Square Coffee Table W395mm	each

D. Primary Seat Pods (Pack of 5)

- Sturdy and firm seats for children and teachers
- Seats 5 children for group or individual work
- Stackable for easy storage
- Choice of 12 different colour options
- Fully waterproof and wipe clean
- Indoor and outdoor use
- Dimensions: Width 38 x Height 20 cm

YPRIBB01	Bright Colours
YPRIBB02	Natural Colours

Tree Stump Soft Seating

- Features a realistic high-definition photographic quality printed design
- Bark print on the sides and wood grain detail on top with a plain brown fabric base
- Lightweight and can be easily transported, stacked and stored
- Made from strong durable 100% waterproof wipe clean polyester fabric for quick and easy maintenance
- Suitable for indoor and outdoor use
- Suitable for children and adult use
- Fire retardant to BS5852
- Double stitching for extra strength



A. Pack of 4 Tree Stumps

- 1 Large and 3 Small pouffes
- Small Pouffe: D380 x H200mm
- Large Pouffe: D450 x H350mm

Y4TREESTO3520



B. Pack of 2 Large Tree Stumps

- Large Size can be used by both children and teachers
- Dimensions: D450 x H350mm

Y2TREESTO35



C. Pack of 3 Small Tree Stumps

- Sturdy and firm seats for children
- Dimensions: D380 x H200mm

Y3TREESTO20



D. Multi Seat Foam Log

- Comfortably seats up to 3 children
- Ideal for one-one reading
- Size: L1000 x D400 x H250mm

YFMLG25



E. Nature Print Bean Bags

- Bring a sense of nature into your classroom with these printed bean bags in 3 designs - Autumn Leaves, Summer Meadow & Spring Grass
- Classic rounded shape provides a comfortable and supportive seat
- Made from water resistant fabric - suitable for indoor and outdoor use
- High-definition photographic printed designs
- Lightweight, portable and fire retardant to BS5852
- Wipe clean polyester for quick and easy maintenance with double stitching for strength
- Dimensions: Height 630 x Dia. 640 mm

YNBBMEAD Summer Meadow

YNBBGRASS Spring Grass

YNBBLEAVES Autumn Leaves



F. Indoor/Outdoor Carry Cushions (Packs of 10)

- Set of realistic digitally printed and natural coloured carry cushions
- Easy-grab handles make these lightweight portable cushions perfect for young learners
- Free storage bag for easy storage
- Cushions are stackable when not in use
- 100% waterproof and wipe clean polyester for quick and easy maintenance
- Suitable for Indoor and outdoor use
- Fibre pad filling provides a comfortable base to sit on or as a cushion to lean on
- Cushion dimensions: Length 430 x Width 430 mm

YNTURCC43 'Nature' Print Cushions

YSESNCC43 'Seasons' Print Cushions

YBRCC43 'Brights' Cushions



Nature

Bean Cushions & Seats

- Good value range of quilted cover, bean-filled seating suitable for younger years
- Wipe clean fabric so can be used both indoors or outdoors.
- All items meet the relevant flame retardancy standards.
- Component parts tested to BS 5852 Ignition source 5.



Best Seller



A. Quilted flopp seat

- Comfortable seat for young children
- Soft quilted cover in a range of bright colours: Aqua (AA), Lime (LI), Orange (OR), Yellow (YW), Purple (PP) or Red (RD) - please specify

YFLOP W500 x D660 x H520mm

B. Small round quilted pouffees

- Ideal for foundation stage children
- Size W300 x D300 x H340mm
- Pack of 6 assorted colours

Y330200 pk 6

C. Small square quilted pouffees

- Ideal for foundation stage children
- Size W300 x D300 x H340mm
- Pack of 6 assorted colours

Y330202 pk 6



D. Large quilted bean cubes

- Suitable for children in Key Stage 1 or 2
- Size 450 x 450 x 450mm
- Assorted Colours

Y330204 pk 6



E. Toddler beanbags

- Mini, toddler sized bean bags
- Size: W400 x D400 x H300mm
- Pack of 5 assorted colours

Y330206 Assorted pk 5



F. Quilted outdoor cushions

- Small square cushions for individual child seats with carrying handle
- Pack 10 (2 each Red, Aqua, Lime, Orange & Yellow)
- Size: W400 x D400 x H180mm

Y330208 Assorted pk 10



G. Pack of 10 Sensory Soft Cushions

- Free storage bag included
- Soft tactile fleece offering sensory experience
- Helps to calm, reduce stress and anxiety
- Machine washable for easy maintenance
- Fibre-filled for comfort

YSSCOLC30 W3000 x L3000mm



H. Primary School Bean Bag Chair

- Lightweight bean bag for use indoors or out
- Wipe clean, durable, waterproof fabric, double stitched for extra strength
- Available in Red, Blue, Lime, Purple, Light Grey, Teal, Ochre - please specify

YPRIBBCH01 D580 x H560mm



F. Dice

- Removable washable covers
- Dice has white vinyl spots

Dice D500 x H500mm

Smile Soft Seating

- Tough enough to take rough and tumble treatment, yet light enough for children to move around
- Mix colour schemes and other items from our range to create your own personal seating environment
- Choice of 3 seat heights to suit nursery & primary years - choose from 310mm, 350mm or 380mm
- Can be upholstered in any choice of vinyl colour (see page 287) or in a choice of fabrics
- Smaller orders may incur a carriage charge
- Please specify fabric colour & seat height



Now in 3 seat heights



A. Smile circular chair

- Overall height 510mm
- W400 x seat D350 Dia.400mm

YKCF001



B. Smile circular pouffe

- W400 x seat D400

YKCF003



C. Smile segment pouffe

- W310 x D400

YKCF004



D. Smile outer curved pouffe

- W350 x D400

YKCF007

Smile Shapes

- An extension to the range
- Choice of 3 seat heights - 310, 350 or 380mm & 3 shapes
- Configure into many different layouts
- Please specify fabric colour & seat height



E. Wedge stool

- W400/530 x D400mm

YKCF008



F. Quadrant stool

- 4 together form a circle (as shown)
- W300/850 x D400mm

YKCF009

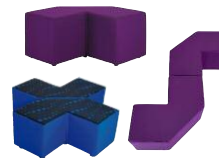

G. Tangent stool

- 2 together form a cross shape
- W560/1000 x D400mm

YKCF010



H. Block stools

YKCS001 W400 x D400mm

YKCS002 W790 x D400mm

Floor Cushions & Trolleys

- Ideal for group reading & teaching activities
- Wipe clean cushions made from high quality vinyl
- Items C & E, cushion colours may vary



Supports group discussion



Extra Value

A. Emotion floor cushions

- Pack of six cushions with multi curricular applications
- Useable as stepping stones or wipe clean story cushions

	Size each	Dia x H
Y330006	350 x 60mm	
Y330008	350 x 60mm	

B. Emotion cushion trolley

- Trolley supplied with 12 donut style cushions
- One side shows facial expression, reverse has key discussion word for group activity
- Trolley size W700 x D360 x H430mm

Y330003 Emotion Cushions & Trolley

C. Plain coloured donut cushions trolleys

- Multi-cushion trolleys comes with 12 or 24 assorted coloured 350mm diameter floor cushions
- Trolley size W700 x D360mm
- 12 seat H430mm, 24 seat H730mm

YFN0080 12 Seat Trolley

YFN0079 24 Seat Trolley

Also suitable for outdoor play.



D. Square cushion trolley

- Brightly coloured 350mm square cushions for classrooms & reading areas
- Cushions are washable at 30°C
- Trolley size W800 x D380 x H400mm comes with 32 assorted coloured cushions 350 x 350 x 20mm

Y330001

Trolleys available separately - please ask for pricing



E. Story cushions

- Durable waterproof, wipe clean cushions
- Ideal for group reading time
- Made to exacting quality standards and finished in soft touch vinyl
- Meets all relevant safety & fire standards
- Dimensions 500mm diameter x 75mm

Y330010 Pastel Assorted pk 10

Y330012 Vivid Assorted pk 10



F. Ladybird counting cushions

- Encourages numeracy skills
- Great for group activities & quiet reading times
- Pack of 13 includes 12 small ladybird cushions (390 x 40mm) numbering from 1 to 12, and 1 larger (480 x 40mm) teacher cushion
- Removable washable covers
- Includes free holdall

Y330014

pk 13

Carpets & Playmats

Carpets on this page have a compact, flatter pile than the heavy duty pile carpets on the following pages.



A. Multi-cultural welcome carpet

- This highly visual carpet has a children around the world theme showing children from different cultures and the word "welcome" in multiple languages
- A durable carpet with an anti slip backing ideal for both the school entrance or the classroom
- Size: W2000 x D1300mm

Y330308



B. Town & country road carpets set

- A set of 4 road map carpets to cover the town, a village, country, farm and airport
- Place in any combination next to each other
- Scaled for most model vehicles, the roads line up to make one large network
- Tightly woven Durable Loop Pile enables easy movement of model vehicles
- Size: W1000 x D1000mm, 4 x squares

YMAT049

set 4



C. Rainbow numbers carpets

- 2 sizes of brightly coloured number carpet
- Ideal for teaching basic numeracy skills
- Choose from 1-100, size: W2 x D1.5m, or smaller 1-24, size: W1.5m x D1m
- Durable tuf-loop

Y330300 1-100 Carpet

Y330302 1-24 Carpet



Outdoor Carpets

- Great for teaching children about the natural world around them, or for outdoor play
- A lighter weight pile making them easier to move
- Include hardwearing, waterproof backing for outdoor use
- For outdoor playgrounds or grass areas



D. Minibeasts indoor mat

- 2.4m x 2m

Y330312



E. Outdoor hopscotch mat

- Ideal for group activities and outdoor play
- Size 3 x 1m
- Outdoor tuf loop

Y330304



F. Garden outdoor mat

- 3m x 2m

Y330306

Please ask for details on our range of outdoor mats

Activity Rugs

- High quality and heavy duty tufted pile, soft texture rugs
- Non crease with a non-slip back
- Stain-resistant coating and washable
- Distinctive and brightly coloured classroom relevant designs
- Stitch binding on all edges to prevent fraying
- Heavy duty pile for comfort

Large range of mats available. Please ask if you cannot find the design you need.

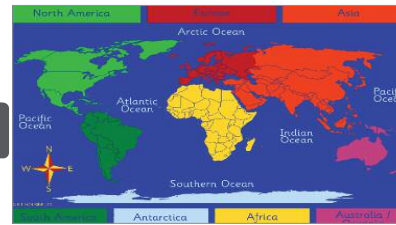

Extra Value

A. Primary world multi-cultural rug

- Brightly coloured, circular rug accurately depicting children from around the world
- Designed to engage discussion into ethnicity and develop cultural and religious awareness
- Ideal group learning aid to introductory multicultural studies
- Size 2m x 2m, circular
- Heavy duty pile

Y330314



B. World carpet

- 3m x 2m brightly coloured rectangular carpet
- Each continent colour coded and labelled
- Ideal group learning aid to introductory Geography
- Heavy duty tufted pile with anti-skid backing

YMAT021



C. Rainbow abc rectangle carpet

- A bright addition to the classroom or nursery environment
- Features 20 brightly coloured ovals surrounded by the alphabet in upper and lower case
- Size: 3m x 2m

YMAT1014



D. Emotions interactive carpet

- Distinctive rectangular carpet W3m x D2m
- Encourages group discussion about feelings & interaction
- Children can choose an expression to sit on during reading or group lessons
- Features 24 x placement spots

Y330318



E. Ladybird numeracy & literacy carpet

- Large 3m x 2m rectangular indoor mat with heavy duty soft pile
- Ideal for cross-curricular use, providing opportunities for developing both numeracy & literacy skills
- Can also be used with the ladybird counting cushions on page 117

Y330320



F. Seasons carpet

- Colourful circular floor carpet covering the seasons, weather and months
- Functional, hard-wearing carpet ideal for group floor reading activities and discussions
- Heavy duty thick soft pile
- Anti-slip rubber backing
- Size: 2 x 2m

YMAT1202

Activity Rugs

- Heavy duty pile for comfort



A. Alphabet mini placement rugs

- 26 square alphabet rugs ideal for temporary classroom floor soft seating activities like reading and group play
- With FREE holdall
- Each rug: W400 x D400mm

YBN0102

set 26



B. A to Z carpet

- Large colourful visually stimulating carpet.
- Designed with KS1 Literacy relevance in mind
- Perfect for children to sit and enhance learning word and letter recognition/ association
- Lowercase and uppercase
- Size: W3m x D2m, rectangular
- Heavy duty pile

YMAT092



C. Rainbow semi-circle carpet

- Extra large carpet for large groups
- Size W2m x D4m
- Features 24 placement spots and 1 teacher spot

Y300308



D. Oval pencils alphabet carpet

- This highly visual oval carpet depicts pencils and the alphabet
- Excellent for group use & word recognition
- Size W3m x D2m
- Heavy duty pile

YMAT1007



E. Fruit placement carpet

- Large square 3m x 3m carpet with soft, heavy duty pile for comfort
- Colourful fruit icons
- To seat 30 children
- Ideal for healthy eating topics

Y300312



F. Life cycle carpet

- Colourful circular carpet showcasing 4 examples of life cycles in the animal and plant kingdoms
- Functional, hard-wearing carpet ideal for group floor reading activities and discussions
- 2 x 2m; heavy duty thick soft pile
- Anti-slip rubber backing

YMAT1213

Sand & Water Play



- Encourages outdoor play
- All sand & water trays have sturdy plastic trays with robust, powder-coated metal frames

Page Link - see page
For wooden sand & water play 129-133



A. Sand & Water Play Table

- Set includes tray with handles, stand with locking castors, breathable lid and plug for drainage
- Tray Colour: Blue

YEY10340BL	Height 40cm
YEY10358BL	Height 58cm

B. Oval Sand & Water Table

- A tinted clear sand and water table with a multi level design and screw-on water valve
- Height 58cm

YFSWTB

C. Circular Sand & Water Play Table

- Durable plastic multi level tray table with a heavy duty steel frame and plastic lid
- Height 58cm

YEY02398



D. Water Tray & Stand

- Sturdy plastic tray with frame and wheels
- Tray available in Red or Clear
- Lid sold separately

YFY02530	Red
YFCROCK	Clear
YFSLID	Lid



E. Creative! Sand & Water Stations

- Suitable for 2 years+
 - Sturdy frame with two wheels & two fixed legs
 - Polycarbonate tray for sand or water
 - Suitable for use with Canopy & Accessory Kit YCRT0199
 - YCRT0198 has room underneath for clear tubs
- | | |
|----------|-----------------------|
| YCRT0197 | W1100 x D620 x H440mm |
| YCRT0198 | W1100 x D620 x H590mm |



F. Creative! Canopy and Accessory Kit

- Canopy made from washable, wipe clean fabric
 - Suitable for 440mm and 590mm units
 - Easy to attach to Sand & Water stations using the Allen key & bolts supplied
 - Incl.: 2 x funnels, plastic tubing & activity shelf
 - Height when attached to YCRT0197: H1440mm and YCRT0198: H1590mm
- | | |
|----------|------------------------|
| YCRT0199 | W1200 x D560 x H1100mm |
|----------|------------------------|

Height Adjustable Mobile Classroom Easels

- These mobile easels with magnetic whiteboards are a perfect teaching aid for front of class
- Sturdy A frame construction guarantees safety & stability at all heights
- Each easel has quick & easy height adjustments to accommodate all age groups - simply click on and off at the height required
- Full length integral pen & book tray and adjustable flipchart fittings
- Castors are fully locking
- Choice of Red-RD or Blue-BL high gloss powder coated metal frame



A. Large a-frame mobile easel

- 4 height adjustments from 1110mm up to 1790mm
- 900 x 900mm magnetic whiteboard
- Two plastic storage trays

Y300400*

*Please specify frame colour Red-RD, or Blue-BL



B. Small a-frame mobile easel

- Smaller version of the large easel for younger years
- Height adjustable from 820 - 1190mm
- Magnetic whiteboard size is 600 x 600mm
- Supplied with 1 x storage tray

Y300402*

*Please specify frame colour Red-RD, or Blue-BL



C. Landscape style easel

- Adjusts from 785 - 1460mm in 5 increments
- Single boarded easel comes c/w 3 storage trays, double boarded with 2 storage trays
- Board size: 900 x 900mm

Y300404* Single Boarded Easel

Y300406* Double Boarded Easel

*Please specify frame colour Red-RD, or Blue-BL

Table Easels

- Solid beech table frames with holes for paint pots etc.
- Magnetic easel sections can be removed & used as floor easels for younger children
- Add paper for drawing & painting by loosening the wheels at the top
- Supplied flat pack for easy self-assembly



Easy Self Assembly



D. 2-person table easel

- Dimensions H1180 x W900 x D600mm

YEAS6592



E. 4-person table easel

- Allows 2 children to work side by side
- Dimensions H1180 x W1480 x D600mm

YEAS6542



F. 4-sided table easel

- 4 easel faces in a square making a more compact easel
- Dimensions H1180 x W900 x D600mm

YEAS6552

Play Corners

- Extensive range of solid beech modular furniture with scratch resistant clear lacquered finish
- Designed to bring storage units and creative play areas together
- Modules fix together with solid beech connecting posts
- Ideal for creating "areas" from larger rooms and establishing boundaries
- Supplied flat packed for easy self-assembly, please ask for pricing for assembly if required
- Accessories and soft furnishings shown are for photographic purposes only and are not included



Some items are available separately as single units – please ask for prices & details

A. Reading corner

- 2 x 1200mm wide shelf units
- 2 x Curved shelf units
- 1 x Corner seating unit with lime cushions
- 1 x 600mm entrance arch
- 2 x Pk2 90 degree posts

Y320101



B. Book corner

- 2 x Curved Shelves
- 1 x Open Bookcase/Shelf
- 1 x Storage Unit
- 1 x Entrance Frame
- 2 x (2 x 90 Degree) Posts
- Seating and kinderbox with mirrors not included

Y320110

set



C. Shopping corner

- 2 x Curved Shelves
- 1 x Entrance Frame
- 1 x Shop Theatre
- 1 x Role Play Panel
- 1 x Angled Tidy Store
- 1 x (2 x 90) Degree Posts
- 1 x 2 x Wallplate
- Tables & chair not included, see page 130 for pricing

Y320109

set

Many components are available separately if required - please ask for pricing



D. Display/store unit

- 2 x Corner Shelf Unit
- 1 x Cork Room Divider
- 1 x Storage Unit with Baskets
- 1 x Room Divider Cork
- 2 x 90 Degree Posts
- 1 x 90 Degree Double Posts

Y320115

set

Wooden Play Furniture

Play modules

- Provides hours of fun for children in Nursery & Primary years
- Frame is free standing so easy to lift & move
- Also ideal for use on stage for school productions
- Arched frame & side panels 15mm beech plywood
- 25mm solid beech dowels form the frame
- Dimensions: W1800 x D1200 x H1200mm
- Supplied flatpacked for easy self assembly (or please ask for pricing for assembly)
- Canopy included in a choice of 3 colours: lime, orange & black
- Please specify colour when ordering



Available in:

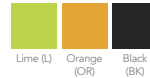

A. Play module

Y320150



B. Play module with 2 sets of curtains

Y320152



C. Play module with 2 sets of curtains, 6 scatter cushions & large mat

Y320154



D. Stage play module

- Useful module for stage productions
- Also provides hours of fun in nursery or early years classrooms for role play
- Solid beech frame with MDF panels
- Open back and half height sides
- Curtains & accessories not included
- Dimensions W1800 x D1040 x H1700mm
- Supplied flat packed for easy self assembly

Y320156



E. Shop canopy with angled tidy

- Choice of wicker baskets or trays, other contents not included
- Supplied flat packed for easy self-assembly

Y1394402 With Trays

Y1394412 With Wicker Baskets



F. Shop canopy with open bookcase

- Contents not included
- Supplied flat packed for easy self-assembly

Y1394422



Please ask for costings for assembly

Natural Beech Storage Units

Double sided beech units

- Uniquely designed double sided units
- Made from 18mm Beech Faced MFC with ABS Edging
- The top of the units can be used as a Play Table and the solid beech frames surrounding the tops prevent items from rolling off onto the floor
- One side has opening doors, or trays, reverse is open shelving
- Supplied flat pack with trays as shown
- Dimensions W940 x D610mm. Accessories not included



Easy Self Assembly

Please ask for costings for assembly



Reverse of items A-D is open shelving



A. Resource unit with doors
• Doors / open shelving reverse

Y1392002



B. Display unit with mirror/top shelves
• Please choose tray colour

Y1392292 With Trays

Y352282 With Baskets



C. Book display unit
• Please choose tray colour

Y1392422 With Trays

Y352412 With Baskets



D. Storage unit with easel
• Please choose tray colour

Y1392232 With Trays

Y352222 With Baskets



Front View



With Trays Sold Separately

E. Mobile art trolley

- Double sided mobile Art Resource trolley made from beech faced MFC with ABS soft edging.
- Incorporates solid beech beadings & rails
- Built-in scissor block & sections for paper, paints, art resources & ribbon rail
- One side has 9 storage compartments to hold plastic trays or willow baskets (sold separately)
- 24 assorted pots & art trays included

Y1393102 H960 x W965 x D600mm



Art Trolley with Baskets sold separately

Choose from baskets or plastic trays

Trays available in:



F. Deep wicker baskets

- W370 x D270 x H200mm
- Pack of 6

YBASKET

pk 6

Single Sided Storage

- Large range of interesting storage units in beech faced MFC with solid beech beading & ABS lippings
- Supplied flat packed for easy-self assembly
- Please ask for costings for assembly if required
- Units supplied with baskets or trays as shown

Please ask for costings for assembly



Contents not include

A. Tiered access unit with 6 trays

- Supplied comes with 6 trays - please specify colour
- Dimensions H870 x W1015 x D460mm
- Also available with wicker baskets - ask for pricing

Y1381492 Right Hand Tiered Unit

Y1381502 Left Hand Tiered Unit

Trays available in:

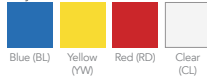

Blue (BL) Yellow (YW) Red (RD) Clear (CL)



B. Tray & shelf unit

- Dimensions W1015 x D500mm

Y1360572 6 Shallow Tray Unit w/cork Pan

Y350372 3 Deep Tray Unit w/flat Top



C. Open display units

- H650mm x D425mm, curve unit W735mm, straight W960mm

Y354002 45 Degree Curve Unit

Y354022 Straight



Page Link - see page
Lunchbox & Bag Storage
77-76



Classroom Tidy Trolleys



- New range of high quality classroom tidy trolleys made from solid beech, finished in a clear natural lacquer
- All units supplied with castors for easy mobility
- Choose from plastic tubs (choice of Clear-CL, Red-RD, Blue-BL, or Yellow-YW), or wicker baskets for a more natural look
- Supplied flat packed for easy self-assembly - please ask about our assembly service if needed
- Single sided or double sided options

Please ask for costings for assembly



D. Single tidy trolley

- Dimensions W860 x D410 x H810mm
- Supplied comes with 9 baskets, or tubs (please specify colour)

Y350000 Single Tidy with 9 Tub*s

Y350002 Single Tidy with 9 Baskets



E. Double-sided tidy trolley

- Dimensions W860 x D740 x H810mm
- Supplied comes with 18 baskets or tubs (please specify colour)

Y350008 Double Tidy with Tub*s

Y350010 Double Tidy with Baskets

Solid Beech Nursery Tables

- Fixed height, solid beech tables with smooth rounded corners in H530mm (suitable for age 4-6) and chunky 45mm solid beech legs
- Stronger table construction with underframe
- Finished with clear lacquer
- Other heights available to order
- Also can be supplied with beech veneer tops at a lower cost POA.

Suitable for Ages 2-8



A. Circular

Y353032	1000mm dia
Y352112	1200mm dia



B. Rectangular

Y353012	960 x 690mm
Y353022	1200 x 690mm
Y352022	1500 x 690mm



C. Square

Y353002	690 x 690mm
---------	-------------



D. Trapezoid

Y353062	1200mm
---------	--------

Adjustable Height Nursery Tables & Chairs

- Height adjustable Beech top tables
- Height adjustable to 4 heights: 400mm, 460mm, 520mm & 580mm
- With solid beech frames, rounded corners and high quality coloured laminate tops with ABS edging, these tables are built to last!

- These tables coordinate with our nursery chairs (see below)

Suitable for Ages 2-8



E. Rectangular tables

- Size W1200 x D800mm

YMRECTBNA



F. Square tables

- Size W800 x D800mm

YMSQTBNA



G. Round tables

- Size W1000 x D1000mm

YMROUTBNA



H. Hexagonal tables

- Size W1020 x D800mm

YMHXETBNA

Nursery chairs

- Stackable, solid hardwood with a natural beech finish
- A pack of 4 in a range of 3 heights



I. Assorted chairs

- 1 each red, yellow, green & blue

YSTCHMIX1	H260mm
YSTCHMIX2	H310mm
YSTCHMIX3	H350mm



J. Beech chairs

YSTCHBCH1	H260mm
YSTCHBCH2	H310mm
YSTCHBCH3	H350mm

Height Adjustable Themed Tables

- Height adjustable themed tables, perfect for group work & very popular in nurseries, primary schools & special schools
- Hardwearing, easy clean 25mm laminate tops with black PVC moulded edging and rounded corners
- 50mm black powder coated frame for scratch resistance and stability, with grey self-levelling feet
- All tables are height adjustable from 430 - 635mm in 25mm increments and suitable for wheelchair users
- The unique Tri-Lock™ leg strengthening system provides maximum leg strength in all heights and protects against multidirectional impacts



Please note that these tables are built to exacting standards and are tested to BS EN 1729-2:2006. Tested by FIRA, these tables are structurally suitable and sufficiently stable for heavy educational use.



Best Seller

A. Horseshoe table

- Top dimension of 1675 x 1520mm

YFN0013A	Red
YFN0014A	Blue
YFN0015A	Yellow



Best Seller

B. Clover table

- Top dimension of 1026 x 1026mm
- Suits group work & student interaction. Seats 4

YFN0007A	Red
YFN0008A	Blue



C. Arc table

- Top dimension of 1600 x 800mm

YFN005A	Red
YFN006A	Blue
YFN0149	Yellow



Best Seller

D. Flower table

- Top dimension of 1525 x 1525mm
- Suits group work & student interaction. Seats 6+ students

YFN0010A	Red
YFN0011A	Blue
YFN0012A	Yellow



E. Rectangular table

- Premium quality rectangle table helping facilitate creative student teacher interaction
- Top dimension of 1500 x 750mm

YFN0156	Red
YFN0157	Blue



F. Teacher's flower table

- Designed for larger group teaching and is perfect for teacher student interaction
- Top dimension of 1525 x 1525mm

YFN0153	Red Table
YFN0154	Blue Table

Outdoor Learning

- Solid wood outdoor play furniture to create a living classroom.
- Helps children to explore & develop their potential through role play learning
 - Encourages healthy outdoor play
 - Made from durable, weather-resistant solid eucalyptus timber: a sustainable product from FSC certified sources
 - Naturally occurring oils contain insect repelling properties
 - Furniture can be left outside



A. Outdoor kitchen with water pump

- Excellent for exploratory & water play
- Features a stainless steel kitchen sink allowing children to play with water coming from the water pump that looks like a real water tap
- H1110 x W1200 x D420mm

Y300162



B. Outdoor kitchen set

- Consists of 1 each outdoor sink, oven & stove, washing machine, refrigerator & microwave
- Dimensions 450 x 350mm x height 620 – 850mm
- Some items can be purchased separately

Y300150



C. Mud mixing table

- Outdoor table c/w 4 x metal inset dishes for mixing
- Great for outdoor teaching or nature studies
- Dimensions 1100 x 1100 x H600mm

Y300152



D. Sorting table

- Outdoor wooden bench c/w lid and undershelf
- Ideal for nature studies, or curriculum activities
- Dimensions H600 x W1200 x D400mm
- Wooden sorting boxes available separately to fit into top of bench.

Y300154 Sorting Table

Y300156 Wooden Sorting Boxes pk 6



E. Outdoor table with stacking benches

- Low table with 2 benches for outdoor use
- Table dimensions W570 x 1060mm
- Requires some assembly
- Parasol sold separately

Y300160 Bench Height 310mm pk 2

Y300164 Table Height 480mm each

Y300165 Parasol each



F. Water & sand table with pump

- Encourages exploratory water play
- Teaches children about water and its effects
- Includes stainless steel sink with pump that looks like a real water tap
- Tables can be repositioned in different layouts
- L1040 x W340 x H560-850mm

Y300170 Set of 3 Tables

Outdoor Play

Outdoor play equipment designed to suit your space

The chance to connect with the natural world; first hand experiences of life and growth; endless opportunities for creativity and imagination; improved fitness and physical development – the countless benefits of outdoor play have a real positive impact on children's lives.

Outdoors is the perfect place to learn through movement, which is one of the four vehicles through which children can learn, the others being play, talk and sensory experiences. All of these happen more naturally outside, but with so much space and so many opportunities to move in different ways, the setting supports learning through movement particularly well.

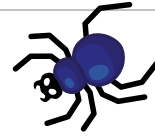

Tiny Castle

Our Tiny Castle is another popular choice for school playgrounds and will help with physical development. Whether pretending to be dragon-slaying knights or kings and queens, castles provide children with oodles of role playing fun. This unit is free standing and can be moved around your outdoor area.

L250 x W150 x H154cm. Platform H60cm

Castle Tower 1800001

Water Wall

Water is a fun and essential element of any playground. Our Water Wall features chutes and tubes and can be fully customised to suit your play area. You can either have a wall without a tank or pump, or you buy the unit with a water tank for storage, or with a tank and pump for the complete Water Wall experience.

L200 x W80 x H150/190cm

Water Wall & Tank 14000301



We offer a complete bespoke service to meet your specific requirements.
Please ask for details
Prices are subject to a site survey and quotation.

Kitchen Units

We've included all the ingredients they need for hours of play in this kitchen set. This handcrafted kitchen includes a Sink, Cooker and Washing Machine. Perfect for small groups of budding homeowners.

L150 x W50 x H50cm 13000101



Messy Kitchen

The messy kitchen is ideal for all those budding cooks and chefs. The unit features bowls for mixing up all sorts of wonderful and messy concoctions. We've made the bowls removable to make cleaning up the mess as easy as possible. Just because children like to get their hands dirty doesn't mean you have to!

L120 x W40 x H68cm

14000101

Play Blocks

Children learn many concepts, especially math concepts, through block play. Play with blocks provides an excellent opportunity for social and physical development and enhances creativity. Not only are they fun and exciting, but they help kids develop a wide variety of skills and abilities. Set of 20 blocks.

21000101



Magnify Table

Encourage children to explore the natural world around them. By incorporating a magnifying table into your play area, you'll be encouraging children to get up close to bugs and insects in a safe and controlled environment. You can even use the table to take a closer look at drawings and artwork.

L35cm x W35cm x H50cm

10000201



Bugs Life

Study mini beast activity throughout the seasons with this attractive, durable and sturdy unit. The Bugs Life consists of multi-habitats allowing children to monitor different insects and spiders.

L50 x W50 x H100cm 10000301



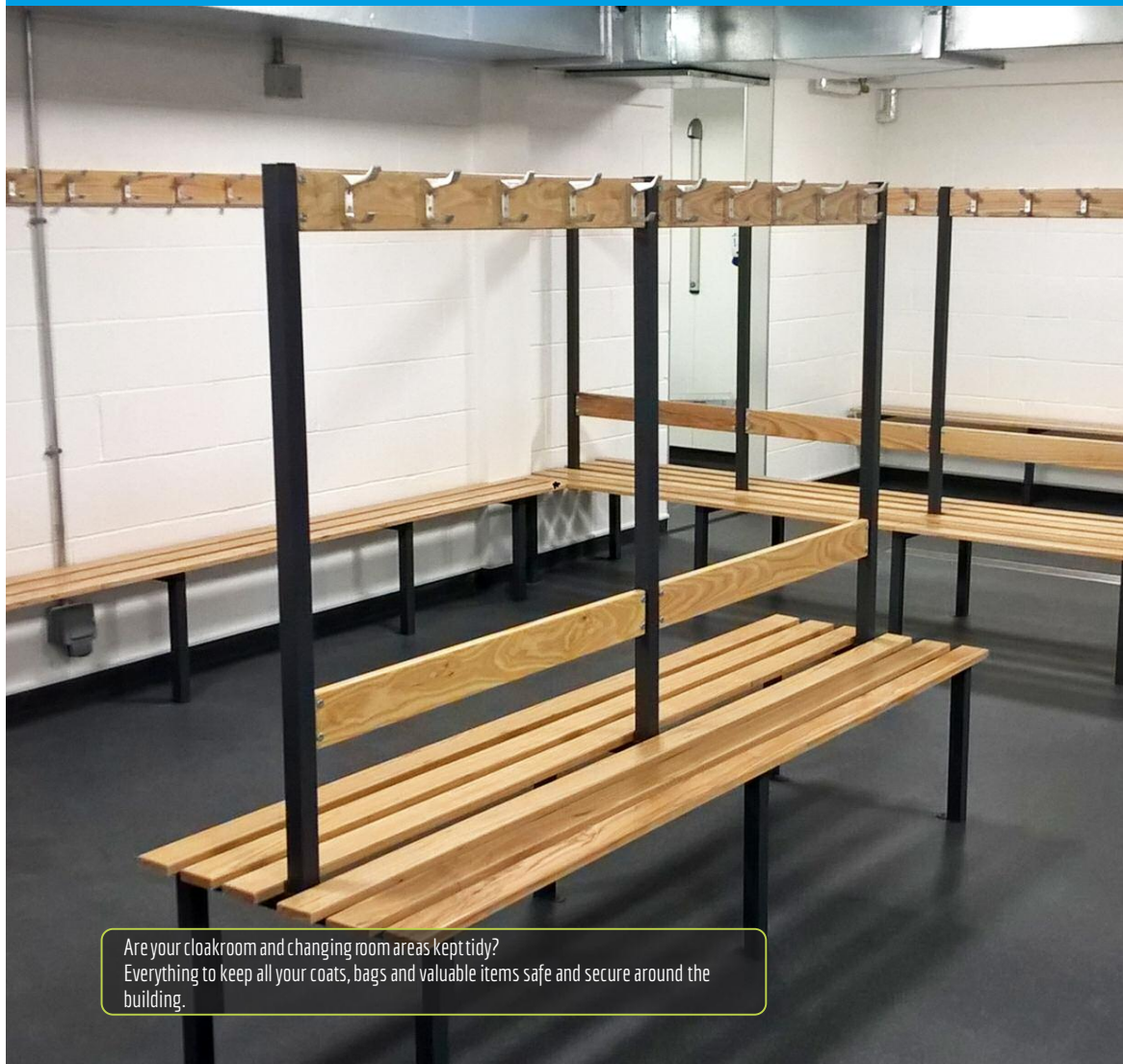

Are your cloakroom and changing room areas kept tidy?
Everything to keep all your coats, bags and valuable items safe and secure around the building.



SPACES TAYLORED

Cloakrooms & Lockers

Bespoke Cloakrooms	134-135
Candy Colours Range	136
Coat Hooks & Rails	137
Lockers	138
DuraStore Interior Lockers	142
DuraStore Exterior Lockers	143
MyLockers	144-145

[Main Content Page](#)

Cloakrooms & Lockers

Keep your cloakrooms tidy with items from our high quality range of cloakroom furniture and lockers.

Secure storage options for changing rooms, staff rooms, receptions and other open areas where valuables are kept.

Many configurations of lockers and benching, including bespoke manufacturing, providing a solution for every requirement.





Standard Bench Options

- Black Frame, Ash Slats
- Other timber finishes available on request.

N1

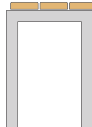

N1	1m	£165.00
N1	2m	£285.00
N1	3m	£400.00

R1



R1	1m	£140.00
R1	2m	£250.00
R1	3m	£355.00

H2

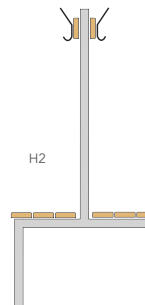

H2	1m	£415.00
H2	2m	£730.00
H2	3m	£990.00

Cloakrooms & Changing Rooms

Other standard bench options, please call for prices.

Many configurations of frames and bespoke manufacturing are available to provide a solution for every requirement.





Page Link - see pages
For
coat
hooks

137



- Heavy duty steel frames
- Free standing or fixed to wall/floor
- Supplied assembled or fitted on site
- Optional shoe rack

- Optional bag rack
- Optional peg rail
- Unique fold down frame for narrow corridors
- Heavy duty ash slats or solid grade laminate

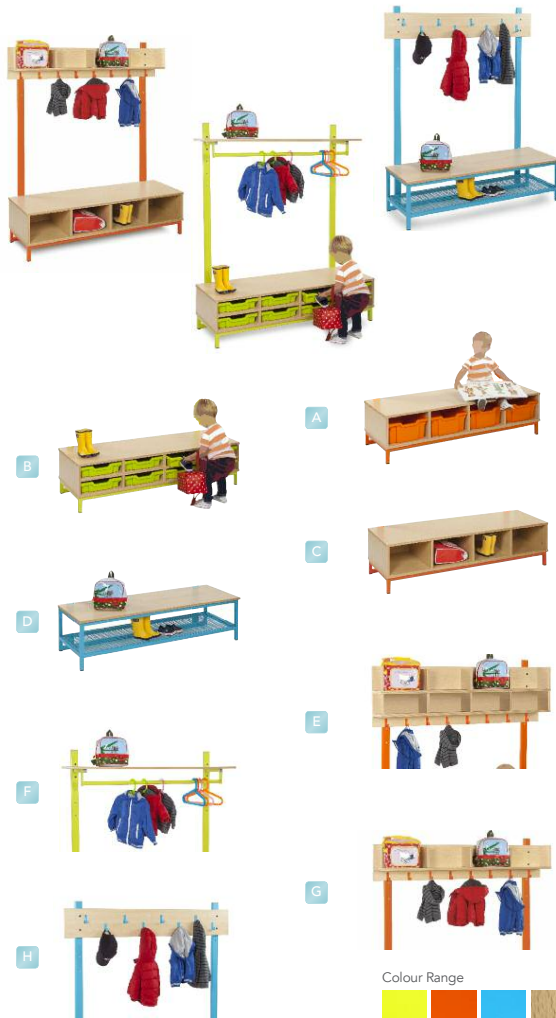

Colours Cloakroom Range



- Mix & match the tops & bottoms of the cloakroom units
- Tops come complete with two height-adjustable upright bars
- All units supplied complete with Grattnell's trays within the price. See page 50 for colour and size options
- Please specify colour at time of ordering
- Choice of Beech, Maple or White

MIX & MATCH!

Use these bases as stand alone units or combine them with any of the top units shown below. Top units come with supporting upright bars.

Cloakroom Bases

- Mix and match these bases with the tops shown below
- Bases supplied without upright bars
- W1360 x D345 x H455mm

A. YCLK002	4 Deep Trays
B. YCLK004	8 Shallow Trays
C. YCLK006	4 Open Compartments
D. YCLK008	Boot Rack

Cloakroom Tops with Upright Bars

- Height adjustable
- Mix and mach with bases shown above
- Supplied with upright bars to attach to bases

E. YCLK001	8 Compartments W1360 x D170 x H410mm
F. YCLK003	Hanging Rail W1360 x D250 x H138mm
G. YCLK005	4 Compartments W1360 x D170 x H250mm
H. YCLK007	8 Hooks W1360 x D40 x H200mm

Colour Range



Coat Hooks & Rails



A. Coat hook rails

- Straight coat hook rails with indented space above hooks for personalisation
- Rail size W1200mm x H195mm
- Comes with 10 assorted coloured hooks
- Natural beech finish

Y91412 Beech Coat Hook Rail



B. Cloakroom hooks & rails

- Colourfull metal coat hooks pre-mounted onto 180mm depth MFC boards
- Choice of 3 finishes: Beech-BE, Maple-MP or White-WH
- Hooks supplied as assorted colours, or specify single colour

320300 8 Hook Rail W1200mm

320302 16 Hook Rail W1500mm

320304 20 Hook Rail W1800mm

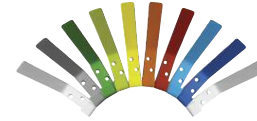

C. Metal hooks only

- Choose from assorted pack or single colours
- Please specify colour for single colour packs
- Packs of 10

320320 Assorted Coat Hooks

320322 Single Colour Hooks



D. 8/16 Compartment cloakroom bench

- Cloakroom storage unit with open compartments
- 3 carcass & 9 frame finishes as below
- 8 compartment: D350 x H515 x W1200mm; compartment size W276 x D174mm
- 16 compartment: D350 x H515 x W1500mm; compartment size W166 x D174mm

320350 8 Compartment

320352 16 Compartment

Colour Range



Beech Maple White

Hook & Frame Colours

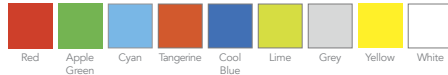

Red Apple Green Cyan Tangerine Cool Blue Lime Grey Yellow White

Page Link - see pages

For bag storage 77



E. Brighthooks

- Strong and colourful plastic hooks
- Packs of 10 single colour
- Please specify colour

320330 Brighthooks pk 10

Brighthooks Colours



Black Dark Grey Light Grey Dark Blue Light Blue Purple Red Orange Green Yellow Pink White



Lockers

ACTIVECOAT anti-bacterial technology

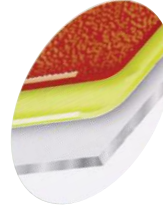

- The hard wearing anti-bacterial powder coating for the most stringent hygienic environment
- Iron Phosphate Key Coat
This anti-rust, key coat bonds to the steel in readiness for the final active coating
- Prepared Steel Surface
Chemical cleaning ensures an ideal surface for further coatings

A. Single compartment

- Including top shelf and double coat hook

Y16100*	H1780 x W305 x D305mm	POA
Y16106*	H1780 x W305 x D380mm	POA
Y16112*	H1780 x W305 x D460mm	POA
Y16118*	H1780 x W380 x D380mm	POA
Y16124*	H1780 x W460 x D460mm	POA

C. Three compartment

Y16156*	H1780 x W305 x D305mm	POA
Y16162*	H1780 x W305 x D380mm	POA
Y16168*	H1780 x W305 x D460mm	POA
Y16174*	H1780 x W460 x D460mm	POA

E. Five compartment

Y16206*	H1780 x W305 x D305mm	POA
Y16212*	H1780 x W305 x D380mm	POA
Y16218*	H1780 x W305 x D460mm	POA

B. Two compartment

- Including double coat hook per compartment

Y16128*	H1780 x W305 x D305mm	POA
Y16134*	H1780 x W305 x D380mm	POA
Y16140*	H1780 x W305 x D460mm	POA
Y16146*	H1780 x W380 x D380mm	POA
Y16152*	H1780 x W460 x D460mm	POA

D. Four compartment

Y16178*	H1780 x W305 x D305mm	POA
Y16184*	H1780 x W305 x D380mm	POA
Y16190*	H1780 x W305 x D460mm	POA
Y16196*	H1780 x W380 x D380mm	POA
Y16202*	H1780 x W460 x D460mm	POA

F. Six compartment

Y16224*	H1780 x W305 x D305mm	POA
Y16230*	H1780 x W305 x D380mm	POA
Y16236*	H1780 x W305 x D460mm	POA
Y16242*	H1780 x W380 x D380mm	POA

* Please specify colour

Call us now for our best prices!

Door colours



Autumn door colours (305mm width only)



When ordering your lockers please specify:
1. nesting 2. carcass colour 3. door colour

Carcass colours



Lock options: Cam lock or Hasp & Staple
supplied as standard

A. Cam lock with key



B. Hasp and Staple (accepts padlock)



Cloakrooms & Lockers

Lockers

- All lockers come as standard with Activecoat anti-bacterial powder coating
- All plastic components used in the manufacturing incorporate a silver based anti-bacterial agent
- Activecoat developed in conjunction with Dupont

All lockers meet:



MEETS BS 4680:1996
excluding size specification



Lock options:



Combination Lock
4 Digit



Digital
Combination Lock



Coin Return
Lock

- Ergonomic Card Holder incorporating a lock cover which protects the lockers from key scratches



- Vent system allows each compartment to 'breathe'



- Between each compartment the locker has a welded plinth. This makes each compartment totally separate and increases structural rigidity



- High visibility key, making identification easy. Hasp and staple locks for padlocks are also available



- Even the standard lock has a micro sprung 10 lock featuring a massive 3000 key combinations



- Every locker has a full strengthener welded into each door to increase security



A. Low lockers single tier

- Including top shelf and double coat hook

Y16400L	H1220 x W305 x D305mm	POA
Y16406L	H1220 x W305 x D460mm	POA

B. Low lockers double tier

- Including top shelf and double coat hook

Y16412L	H1220 x W305 x D305mm	POA
Y16418	H1220 x W305 x D460mm	POA

C. Cube lockers

Y16248	H305 x W305 x D305mm	POA
Y16250	H380 x W380 x D380mm	POA
Y16252L	H460 x W460 x D460mm	POA

Nesting available - please ask for details

D. Janitors lockers

- Including double coat hook

Y16424L	H1780 x W460 x D460mm	POA
---------	-----------------------	-----

POA Price On Application





Numbering System

Available at additional cost.
Number plates will be recessed into door if ordered with lockers.

Lock Options

High Security

Welded Compartment divider incorporates internal door stop and sill

New 180° Opening

This strong hinge offers 180° wide opening.

Hinge Securing Plate

This strong hinge incorporates an integral securing plate which clamps the door to the hinge giving added security.

Activecoat

Anti-bacterial technology



Available in 1, 2, 3 and 4 tier

Single and two tier doors subject to minimum quantity.

Cloakrooms & Lockers



overlay doors

New 180° Opening Hinge

This hinge offers unparalleled levels of access to each compartment making full use of clear entry.



Trespa Athlon Fire Classification

Type: Standard (Non-FR): Euroclass D-s2, d0EN 13501-1
 Type: FR (Fire Resistant): Euroclass B-s2, d0EN 13501-1
 (available at additional cost)



Stock Door Colours

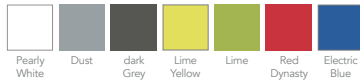

Single and two tier doors subject to minimum quantity.

Non stock colours subject to minimum quantity of 25 doors.



Laminate doors

10mm solid grade laminate inset doors.



DuraStore - interior plastic lockers

10 Year
Warranty

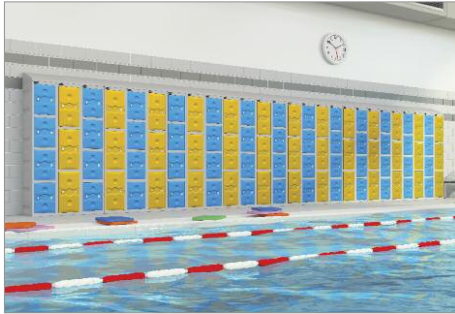

Call us now for
our best prices!

Locks



Interior Lockers



For use inside buildings, including near humid areas, near showers and swimming pools.

- Strong and dent resistant
- Cannot rust
- UV resistant
- Plastic contains additive to resist bacteria, moulds and yeasts
- Recyclable
- Locker floors slope to the door and drain channels
- Quick installation - one piece unit saves assembly time
- 10 year warranty under normal use
- Frame - speckled light grey

EDP001	4 Doors H1800 x W325 x D450mm
EDP002	3 Doors H1800 x W325 x D450mm
EDP003	2 Doors H1800 x W325 x D450mm
EDP005	1 Doors H450 x W325 x D450mm
EDP006	2 Doors H900 x W325 x D450mm

Lock Options: Lockers supplied with water resistant cam lock or hasp lock. Other options listed below.

EDP015	Water Resistant Cam Lock Type 1
EDP016	Water Resistant Hasp & Staple Lock
EDP017	Full Waterproof Cam Lock Type 2
EDP018	Re-programming 4 Digit Number Finding Key
EDP019	Water Resistant Budget Combination Lock 4 Digit Override Key
EDP020	Waterproof Coin Return Lock ASSA
EDP021	Waterproof Coin Retain Lock ASSA
EDP022	Waterproof Digital Combination Lock
EDP023	Simple RFID Lock

- Doors available in Red, Yellow, Blue, Graphite Grey - please specify door colours and door colour order



DuraStore - exterior plastic lockers

Exterior Lockers



For exterior use. Fitted with neoprene interior door seals and IP waterproof cam locks or hasp.

- Site lockers outside - never run out of space again
- Strong and dent resistant
- Cannot rust
- UV resistant
- Plastic contains additive to resist bacteria, moulds & yeasts
- Recyclable
- Locker floors slope to the door and drain channels
- Quick installation - one piece unit saves assembly time
- 10 year warranty under normal use
- Frame - speckled light grey

EDPX007	4 Doors H1800 x W325 x D450mm
EDPX008	3 Doors H1800 x W325 x D450mm
EDPX009	2 Doors H1800 x W325 x D450mm
EDPX010	1 Doors H450 x W325 x D450mm
EDPX011	2 Doors H900 x W325 x D450mm

Lock Options: lockers are fitted with neoprene internal door seals and IP waterproof locks or hasp but other waterproof locks are available as follows:

EDP017	Full Waterproof Cam Lock Type 2
EDP020	Waterproof Coin Return Lock ASSA
EDP021	Waterproof Coin Retain Lock ASSA
EDP022	Waterproof Digital Combination Lock

- Doors available in Red, Yellow, Blue, Graphite Grey - please specify door colours and door colour order



10 Year Warranty



DuraStore options

These options are available for both interior and exterior lockers

EDP011	Sloping Top W325 x D450mm
EDP012	Engraved Number Disc
EDP013	Nesting Nuts & Bolts with Rubber Washers
EDP014	Adjustable Feet - Set of 4
EDP024	Locker Stand - Nest 2
EDP025	Locker Stand - Nest 3
EDP026	Locker Stand - Nest 4





Anti-Bacterial Powder Coating 
An effective secondary support to existing cleaning practices

Options

- Sloping top option
- Lockerstands to raise off floor
- Numbered plate and key fob
- Masterkey
- Combination lock
- Electronic lock
- £1 coin Coin return lock



Sloping top option



Lockerstands

Lockers are supplied complete with key lock. Padlock fittings can be supplied (does not include actual padlock) at no extra charge - must be specified at time of order.

550mm deep lockers available - ask for details
Special requirements eg. - Non-standard sizes, internal fittings - ask for details

Mylockers

Single door locker

Code	Size (h x w x dmm)	Opening (h x w x dmm)	Single	Nest 2	Nest 3
YMY8331	1800 x 300 x 300	1410 x 235 x 275	✓	✓	✓
YMY8341	1800 x 300 x 450	1410 x 235 x 425	✓	✓	✓
YMY8441	1800 x 450 x 450	1410 x 385 x 425	✓		

Supplied with shelf and double coat hook

2 door locker

Code	Size (h x w x dmm)	Opening (h x w x dmm)	Single	Nest 2	Nest 3
YMY8332	1800 x 300 x 300	835 x 235 x 275	✓	✓	✓
YMY8342	1800 x 300 x 450	835 x 235 x 425	✓	✓	✓
YMY8442	1800 x 450 x 450	835 x 385 x 425	✓		

Supplied with double coat hook in each compartment

3 door locker

Code	Size (h x w x dmm)	Opening (h x w x dmm)	Single	Nest 2	Nest 3
YMY8333	1800 x 300 x 300	540 x 235 x 275	✓	✓	✓
YMY8343	1800 x 300 x 450	540 x 235 x 425	✓	✓	✓

Supplied with no internal fittings

4 door locker

Code	Size (h x w x dmm)	Opening (h x w x dmm)	Single	Nest 2	Nest 3
YMY8334	1800 x 300 x 300	400 x 235 x 275	✓	✓	✓
YMY8344	1800 x 300 x 450	400 x 235 x 425	✓	✓	✓
YMY8444	1800 x 450 x 450	400 x 385 x 425	✓		

Supplied with no internal fittings

5 door locker

Code	Size (h x w x dmm)	Opening (h x w x dmm)	Single	Nest 2	Nest 3
YMY8335	1800 x 300 x 300	310 x 235 x 275	✓	✓	✓
YMY8345	1800 x 300 x 450	310 x 235 x 425	✓	✓	✓

Supplied with no internal fittings

6 door locker

Code	Size (h x w x dmm)	Opening (h x w x dmm)	Single	Nest 2	Nest 3
YMY8336	1800 x 300 x 300	260 x 235 x 275	✓	✓	✓
YMY8346	1800 x 300 x 450	260 x 235 x 425	✓	✓	✓

Supplied with no internal fittings

8 door locker

Code	Size (h x w x dmm)	Opening (h x w x dmm)	Single	Nest 2	Nest 3
YMY8338	1800 x 300 x 300	185 x 235 x 275	✓	-	-
YMY8348	1800 x 300 x 450	185 x 235 x 425	✓	-	-

Supplied with no internal fittings

Mylockers

Single door low height lockers

Code	Size (h x w x dmm)	Opening (h x w x dmm)	Single	Nest 2	Nest 3
YMY13331	1370 x 300 x 300	1250 x 235 x 275	✓	✓	✓
YMY13341	1370 x 300 x 450	1250 x 235 x 425	✓	✓	✓

Supplied with a shelf and double coat hook

2 door low height lockers

Code	Size (h x w x dmm)	Opening (h x w x dmm)	Single	Nest 2	Nest 3
YMY13332	1370 x 300 x 300	610 x 235 x 275	✓	✓	✓
YMY13342	1370 x 300 x 450	610 x 235 x 425	✓	✓	✓

Supplied with double coat hook in each compartment

3 door low height lockers

Code	Size (h x w x dmm)	Opening (h x w x dmm)	Single	Nest 2	Nest 3
YMY13333	1370 x 300 x 300	400 x 235 x 275	✓	✓	✓
YMY13343	1370 x 300 x 450	400 x 235 x 425	✓	✓	✓

Supplied with no internal fittings



Special Low Height



Bridge Lockers

Bridge units

Code	Size (h x w x dmm)	Number of Compartments
YMY811AR	1800 x 1500 x 450	11
YMY818AR	1800 x 2100 x 450	19

Call us now for our best prices!

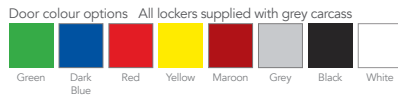

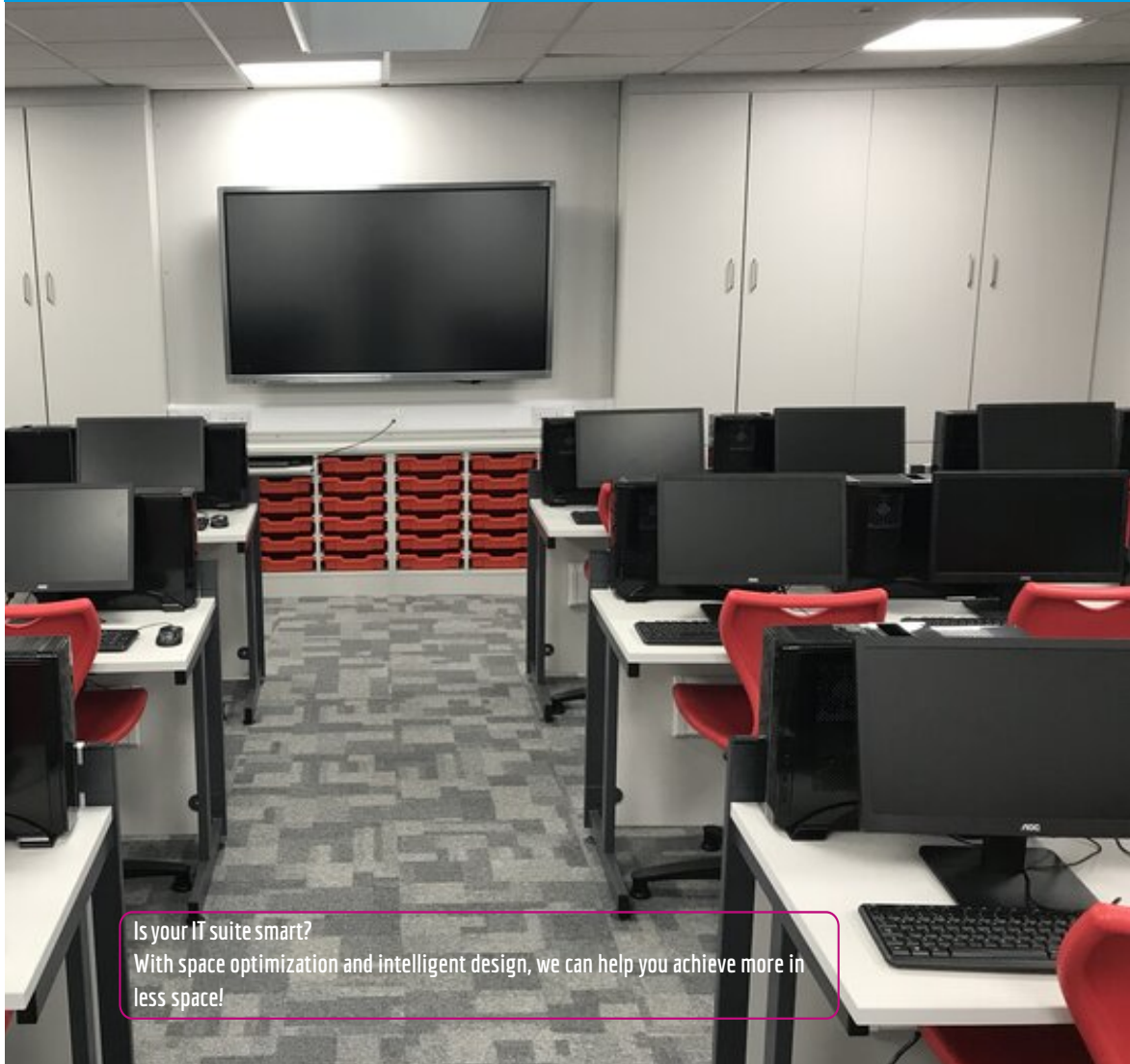

Is your IT suite smart?
With space optimization and intelligent design, we can help you achieve more in less space!



SPACES TAYLORED

IT Suites

Bespoke IT Benching Solutions	148-149
IT Poly Seating	150-152
IT Upholstered Seating	153
Stools	154
Computer Trolleys	155-156
Charge Lockers	156-158
Laptop Storage	159
AV Collaboration Tables	160

[Main Content Page](#)

IT Suites

When it comes to creating your ideal IT suite we can design a unique solution for your requirements.

Whatever surface, size or colour, we have a range of standard units and bespoke solutions that will meet the most demanding needs and technical requirements for the most effective IT teaching space.

From built in lap top charging units down to individual chairs, we can tailor your IT suite to your own needs and we don't stop with the delivery, we can fit them, wire them and commission on site.



Due to limitations in the printing process, wood and colour finishes shown throughout the catalogue may not be representative of actual colour. Samples are available on request.

IT BENCHING SOLUTIONS



Ask about our
FREE space planning
& design service



Flat Panel & Goal Post Legs

Panel Leg

Heavy duty panel leg for a solid timeless look that can be scribed to fit many room requirements. Options include a full range of popular frame finishes/colours with strong matching edging for a quality finish, and additional cable management. Available in any dimension to suit your space – please enquire!

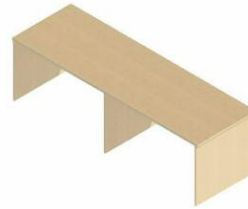

Goal Post Style Leg

Very strong and stable leg option – an adjustable style for accurate lengths in any room, provides extra cable management options. Available in a full range of popular frame finishes/colours, and any height or depth dimension to suit your space - please enquire!



IT BENCHING SOLUTIONS

Adjustable Front Legs & Cantilever Legs

Aluminium Adjustable Track Leg Benching

The ultimate benching system, with highly flexible features to suit most rooms. Incorporating clever rail systems that allow for accurate adjustment and easy reconfiguration options. Options include cable management and a range of popular frame finishes/colours. Available in a range of depths and heights to suit your space - please enquire!



Ask about our
FREE space planning
& design service

Cantilever Leg

The cantilever leg is a strong and smart option. The desk-style leg provides good knee space and allows for modesty panel option. Other options include additional cable management as well as a full range of frame finishes/colours to match. Many height and depth options to offer - please enquire.



5 Year
Warranty

A



A. Flow IT chair

- Virtually indestructible shell
- Tamperproof - all metal height adjustment lever
- Suitable for junior or adult use
- In stock for rapid delivery
- Seat height 390 - 520mm
- Available with glides or castors
- Small order charge applies

YENIT50 each



B



B. Profile swivel chair

- Profile is a modern, comfort designed, swivel chair certified for education and suitable for a wide range of applications
- Available with casters or glides
- Seat is available in a range of colours to suit the clients space
- Seat height 430-560mm
- Overall width and depth: 600 x 600mm

YCONTX2-B With Black Nylon Base
YCONTX2-C With Chrome Base

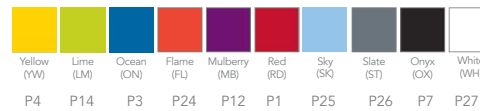

A. Vogue IT chair

- Ergonomic and dynamic Swivel Chair that supports the user in all directions
- One Piece 100% Recyclable shell
- 5 Year guarantee
- Ergonomic and strength compliant to education standard
- 12 Vibrant Shell colours
- Available with castors or glides (please specify)

YVG3601

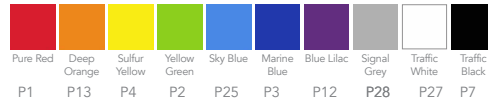

5 Year Warranty

A



Phone For Bulk Prices

Page Link - see page
For more Positive Posture 37

B. Positive Posture IT chair

- Stylish chair with chrome base, complements the positive posture 1 piece polypropylene chairs
- Junior colours: Green, Yellow, Red, Blue, Purple, Lime, Sky, Orange
- Additional adult colours: Grey, Charcoal, Black, Burgundy
- Fabric seat pads also available - POA
- Available with glides or castors (please specify)
- Small order charge applies

	seat height
YPP101J Junior Height	405 - 460mm
YPP102A Adult Height	465 - 555mm

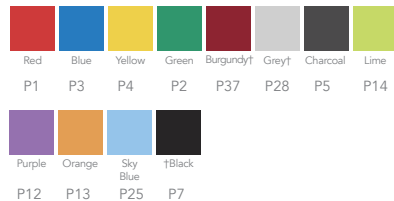

B



5 Year
Warranty

A



A. FourStar Educational Chair

- 5 standard colours
- Large writing tablet mounted on gas column caters for left and right-handed users
- 5-star black base on black castors

FOUR/TAB

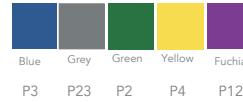

Phone
For Bulk
Prices

5 Year
Warranty

B



B. Pennine swivel chair

- Innovative design for perfect postural support
- Seat back with pelvic support relieves Pressure
- Black 5 star base with Gas lift
- Seat height range of 420-555mm
- Available with castors or glides (please specify)

Y100166



Phone For Bulk Prices

A



A. IT mid back operator chair

- Medium back operator chair
- Built in the UK for the educational market
- Non marking wheels to protect floors
- Black 5 Star base as standard
- 5 year guarantee
- Dimensions: W500 x D550 x H860mm
- Seat height range: 475 - 605mm
- Available with castors or glides
- Available in 3 standard fabric colours: charcoal, royal blue and burgundy – for other fabrics POA



Glides Castors

Y20106IT

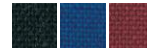

Charcoal Royal Blue Burgundy

Best Seller 5 Year Warranty

B

Colour Options

Choose
1. Colour see pages 281-284
2. Castors or glides



B. Student IT tamperproof



- This strong and comfortable chair is proven in education, and is one of the most popular IT chairs on the market
- The seat and back are joined with two robust metal struts either side, with a very strong underseat frame and just one tough height adjustment ring
- The chair is designed and built for this purpose and offers great value for money



Glides Castors

		Height Range
Y15066	With Castors	400-600mm
Y15068	With Glides	400-600mm
YTWOT	Addn. Charge for 2-Tone Fabrics from Band 1	

Fabric ranges shown on page 276-279 or ask for a swatch

C



C. IT tamperproof operator chair

- Medium sized back operator chair with tamperproof fixings
- Built in the UK for the educational market
- Available with castors or glides – please state
- Black 5 star base
- 5 year guarantee
- Dimensions: W500 x D460 x H890mm
- Seat height range: 465 – 595mm
- Available in 3 standard fabric colours – charcoal, royal blue and burgundy
- For other fabrics POA



Glides Castors

Y32013TP



Charcoal Royal Blue Burgundy

A. Junior small IT swivel chair

- Heavy duty junior size operator
- Built in the UK for the educational market
- Flame retardent foam
- Black 5 star base as standard
- Available with castors or glides
- Dimensions: W450 x D560 x H810mm
- Seat height range: 470-570mm
- Available in a wide range of fabrics

Y32013



A

B. IT stool

- Available with black/chrome components
- Castors available: standard castors (as shown on image), rubber castors, brake loaded castors, manual locking castors, or glides
- A choice of 90 Advantage and Phoenix colours



Choose:
1. Colour see pages 281-284
2. Castors or glides

Gas Lift

YTSB Standard Stool Black Base

YTSC Chrome Frame

Phoenix, Era and Rivet fabric ranges shown on pages 284-287 or ask for a swatch.



B

C. Saddle stool

- Soft touch polyurethane seat on PU Saddle
- Black 5-star base on Saddle and Perch
- Castors as standard on Saddle and Perch.
- Glides available as option
- BS 5459 Part 2: 2000

292/B/P



▲ Laboratory



▲ Industrial Technical



Choose:
1. Colour see pages 281-284
2. Castors or glides



C

A



A. Trike

A perfect option for student and training environments with an extra-large tablet and bag storage tray.

Product Information

- Injection moulded polypropylene frame in white or grey
- Polypropylene seat in 4 standard colours
- Large tablet suitable for laptop
- Upholstered seat pad available
- Anti-Panic mechanism on writing tablet tested to 50kg loads (right-hand available only)
- Tripod base 600mm diameter in grey

TRIKE2/T



Page Link - see pages
For Laptop Tables
247



5 Year
Warranty

B



B. Mobile+ chair

- A unique, adjustable multi-functional chair designed to offer maximum comfort & ergonomic support to the user
- Integrated rotating writing tablet, dashboard and storage facilities for a cooperative and agile learning experience
- Moulded one piece flexible seat shell with a U-shaped back offering superb lumbar support
- Fabric seat pad option
- Integrated tilt mechanism and gas lift
- Black 5 star base with castors
- Available in 4 shell colours
- 5 year warranty

Campus 350

Campus 351



Aqua P25 Red P1 Green P2 Grey P28

Computer Trolleys

A. Mobile computer work station

- Fixed printer shelf
- Fixed bottom Shelf
- Compact and mobile workstation solution
- Dimensions: W675 x D470 x H815mm

YCF7038



New Product

A

B. Mobile computer work station with sliding keyboard shelf

- Fixed printer shelf
- Fixed bottom Shelf
- Compact and mobile workstation solution
- Includes sliding keyboard shelf
- Mouse shelf included
- Height adjustable version also available
- Dimensions: W675 x D470 x H815mm

YCF0716



New Product

B

C. Equipment storage locker

- 16 compartment locker for flexible charging and storage of smaller costly items.
- Useful for the distribution of multiple IT devices
- Each shelf has 1 socket included for charging purposes
- Offers efficient use of space
- Robust and sturdy steel construction
- White carcass with a choice of door colours – choose from blue, red or white
- Key options available

YLK16TE

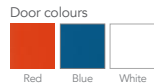

C

A



Single power socket located at the rear of each compartment

Charge Lockers

Charging and security solutions for laptops, netbooks, tablets, Apple devices and other IT equipment.

- All charging units are CE marked (marking on a product is a manufacturer's declaration that the product complies with the essential requirements of the relevant European health, safety and environmental protection legislation)
- All doors are secured to a welded locker frame by a solid vertical rod acting as the hinge
- All the units are manufactured from 0.9 mm steel for the doors and frame and 0.7mm for the backs and sides.
- All compartments have a transparent lock cover incorporating the facility to number each door to help identification
- Each charging compartment has a rear perforated panel to allow excess heat to dissipate

B



A. 16 Compartment mobile charge trolley

YCH16M Locker 1200 x 760 x 525mm

C



B. 15 Compartment charge

YCH15 Locker 1780 x 380 x 525mm

C. 4 Compartment charge

YCH04 Locker 1780 x 380 x 460mm

Door colours

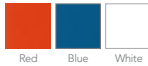

Red Blue White

Carcass colours



White

Charge Lockers



Power 2 Learn charging trolley & charging inserts

- This slim-line trolley has one of the smallest footprints in the market which makes this a perfect low cost and practical device charging option for smaller classrooms or learning areas
- The trolley can hold either 2 extra deep power trays or 3 deep power trays (see ordering options below)
- Each tray can charge a variety of USB devices in lightning fast speed using dynamic device recognition
- Lockable trolley to securely store and charge tablets and small devices
- Trays available to order separately (not recommended for secure storage of devices)
- Each tray comes with a UK socket adaptor – simply plug in, switch on and connect up to 10 USB devices to charge
- Trays available only in silver grey or white
- Steel trolley available in 5 modern bright colours: silver, white, power blue, power pink and power yellow
- W423 x D454 x H957mm (inc. handle)



YP2L102	Trolley with 2 Extra Deep Charging Trays
YP2L103	Trolley with 3 Deep Charging Trays
YPTCF02	Deep Charging Tray ONLY
YPTCF02.5	Extra Deep Charging Tray ONLY





Laptop Storage

Lapcabby - vertical

- 10, 15 (includes projector and printer storage), 16 and 20 port laptop trolley
- Lockable unit to securely store and recharge laptops - sequential power supply included
- Specifically designed and tested air venting system maintains the security of the unit whilst increasing ventilation
- Soft rubber grips cushion and protect laptops when in storage and large L-shaped doors and sliding shelves provide easy, clear access to laptop storage compartment

a. YLAPC10V	LapCabby 10V W616 x D703 x H1115mm
b. YLAPC15V	LapCabby 15V W1015 x D703 x H1115mm
c. YLAPC16V	LapCabby 16V W1015 x D703 x H1115mm
d. YLAPC20V	LapCabby 20V W1015 x D703 x H1115mm

Lapcabby Colours



Lapcabby - horizontal

- 16 and 32 laptop trolley
- Stored on an individual sliding tray for improved accessibility
- Lockable unit to securely store and recharge laptops - sequential power supply included
- Rear facing doors allows easy access to the individual AC adapters supplied with laptops
- The Power7 timer allows schools to program which time each day they would prefer to charge their laptops according to the class schedule or Economy 7 to reduce energy bills
- An innovative cable storage system that keeps cables compact, neat and tidy

e. YLAPC16H	LapCabby 16H W857 x D703 x H1215mm
f. YLAPC32H	LapCabby 32H W1291 x D703 x H1215mm



SYNERGY BLADE

Standard Paint Finishes



Standard Worktop & Edge Banding Finishes

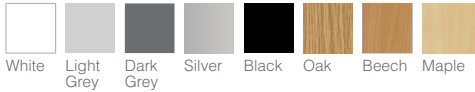

Make it your own!
We offer a range of non-standar



Collaboration is key
Creating active learning environments to enhance student collaboration.



Communicate & share
Our table shapes help promote discussion and enhance engagement



Models

BLADE 4	SY4BE04	POA
BLADE 6	SY4BE06	POA
BLADE 8	SY4BE08	POA
BLADE 10	SY4BE10	POA

Dining Rooms



Are your dining facilities inspiring and inviting?
Stylish, robust dining solutions give more capacity, better flexibility and
stunning looks.



SPACES TAYLORED

Dining Furniture

Tilt Top Tables	163	Folding Tables	171
Benchmark Folding Tables	164	Fresco Benches & Tables	172
Folding Tables with Stools	165	Dining Chairs	173-178
ConverTable	166	Stools	180
Wall Pocket Tables	167-168	Cafe Tables	180-181
Ultimate Table/Bench	169	Statik Range	182-183
Concept Table/Bench	170		

[Main Content Page](#)

Dining Furniture

Dining areas are much more than just places to feed students. They need to be welcoming and desirable places to eat and socialise, places that students feel comfortable in and spaces that attract them.

With our extensive experience we can help you create just the right ambience that will appeal to students and staff alike.

Whether it's a modern, sleek look for a new facility or a more traditional style to suit existing surroundings, we can help you achieve just the right effect that is hygienic, effective and inspiring. Whatever your requirements, we have a feast of ideas and valuable experience!





Flip Top Tables

- These premium quality flip-top tables are built to endure years of daily treatment
- Suitable for education environments and multi-use dining halls
- A full-length release mechanism and 4 braked castors ensure tables are safe and secure to use
- The flip-top functionality allows the tables to be easily stored away after use
- The tops are well balanced, robust and reliable, whilst the all-steel frame ensures a highly durable construction
- Comes as 71.5cm height as standard

A. Rectangular Flip-Top Table

Y360354	1000 X 800mm
Y360356	1200 X 800mm
Y360358	1400 X 800mm
Y360360	1600 X 800mm

B. Semi-Circular Flip-Top Table

Y360362	1000 X 800mm
Y360364	1200 X 800mm
Y360366	1400 X 800mm
Y360368	1600 X 800mm

C. Trapezoidal Flip-Top Table

Y360370	1000 X 800mm
Y360372	1200 X 800mm
Y360374	1400 X 800mm
Y360376	1600 X 800mm



Benchmark folding table with benches

- Folds flat for compact storage
- Height-adjustable
- Lift assist system
- Clears standard doorways
- Patented DoubleGuard® protects against tipping while table is being moved into storage position
- Tables nest compactly, requiring only 28cm of space centre-to-centre
- Tables feature compression spring Lift Assist for smooth, controlled operation
- Top design allows continuous end-to-end table placement
- Folded table easily clears standard door frames. Folded heights range from 1310 to 1920mm
- Edges are finished with EdgeGuard™, providing superior resistance to moisture and eliminating unsanitary food traps
- Width: Top 762mm; Bench 229mm; Total 1400mm
- 15 year warranty

	Table length cm	Seat capacity	Table & Bench height cm	Folded height cm
Y16074	247	10 - 12	69/43	131
Y16076	308	12 - 14	69/43	162
Y16078	369	16 - 20	69/43	192
Y16080	247	10 - 12	74/43	131
Y16082	308	12 - 14	74/43	1628
Y16084	369	16 - 20	74/43	192



Table Colours

Most popular - more available on request at no extra cost



Frame Colours

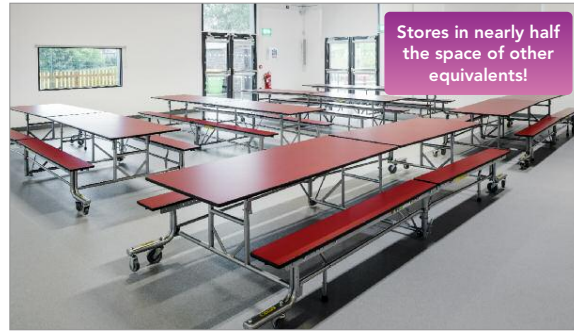
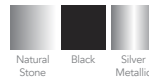

Image shows Port laminate tops – many colours available, please ask

Ask
For A
Demo

15 Year
Warranty



- ✓ Folds flat for compact storage
- ✓ Height-adjustable

- ✓ Lift assist system
- ✓ Clears standard doorways

Stores in nearly half the space of standard folding dining furniture

- Stores in 44% less space
- Seats up to 20 students
- Reduces lunchtime set-up



Folding dining tables with stools

- 18mm MDF core top with hard wearing high-pressure laminate surface for high endurance
- Tops have a seamless edging making them moisture resistant and resilient to damage
- All moving parts are secured with locking nuts and bolts to prevent detachment over time
- Units come with patented centre lock bar system which includes override mechanism for compact storage and transit position for safe handling and set-up
- Choice of two heights (primary and secondary) The folding rectangular table is also available with 16 stools x H160mm for infant schools only
- 14 table top colours to choose from and 11 stool colours to choose from
- 15 year warranty on welds and mechanisms and lifetime warranty on all welded parts



Folding Rectangular Tables

Y360640 With 8 Stools x H690mm

Y360642 With 8 Stools x H740mm

Y360644 With 12 Stools x H690mm

Y360646 With 12 Stools x H740mm

Folding Round Tables

Y360650 With 8 Stools x H690mm

Y360652 With 8 Stools x H740mm

Folding Oval Tables

Y360614 With 12 Stools x H690mm

Y360616 With 12 Stools x H740mm

Folding Octagonal Tables

Y360654 With 8 Stools x H690mm

Y360656 With 8 Stools x H740mm

Folding Wheel Chair Access Tables

Oval or Rectangular with Stools POA

Table height guide

740mm 11 years to adult

690mm 7 to 11 years

660mm 4 to 11 years

610mm 4 to 7 years

Colour Options When ordering please specify:
1. Table colour
2. Stool colour

Stool colours

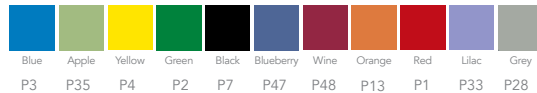

Table top colours



ConverTable bench table

- Converts easily from a single-sided table to a comfortable bench. Two tables together make a full size cafeteria table
- Ideal for auditorium, lunchroom and additional classroom seating
- New 64cm high model available for early childhood applications
- Optional linking mechanism connects tables together securely.
- Dimensions – Back / Top width 38cm / Seat width 31cm
- 15 year warranty

Ask
For A
Demo

Phone
For Bulk
Prices

	Table length cm	Seat capacity children	Table & Bench adult	height cm
Y16050	122	3	2	64/38
Y16052	183	4	3	64/38
Y16054	213	5	4	64/38
Y16056	244	6	5	64/38

Y16058	122	3	2	69/38
Y16060	183	4	3	69/38
Y16062	213	5	4	69/38
Y16064	244	6	5	69/38

Y16066	122	3	2	74/43
Y16068	183	4	3	74/43
Y16070	213	5	4	74/43
Y16072	244	6	5	74/43

Approximate seat widths: 406mm per child, 483mm per adult



New space-saving
frame style as shown

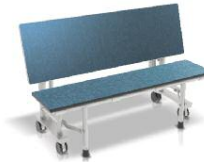

Auditorium Seating
Arranged in rows, these units can convert a rarely used room to a useful auditorium.



Cafeteria Seating
Two tables placed back-to-back become a standard sized table.

Picture shows two tables



Classroom Seating
Reconfigure tables in rows for study or exams.



Folds up easily
for storage

When ordering please specify:
1. frame colour
2. table colour

Frame Colours



Natural Stone Black Silver Metallic

Please ask for our full colour chart at no extra charge

Table colours - more available on request



Grey Nebula Lapis Blue Cool Wind Island Green Orange Grove Fusion Maple



Suitable for installation to existing as well as new build halls

Ask For A Demo
15 Year Warranty

Custom table design available



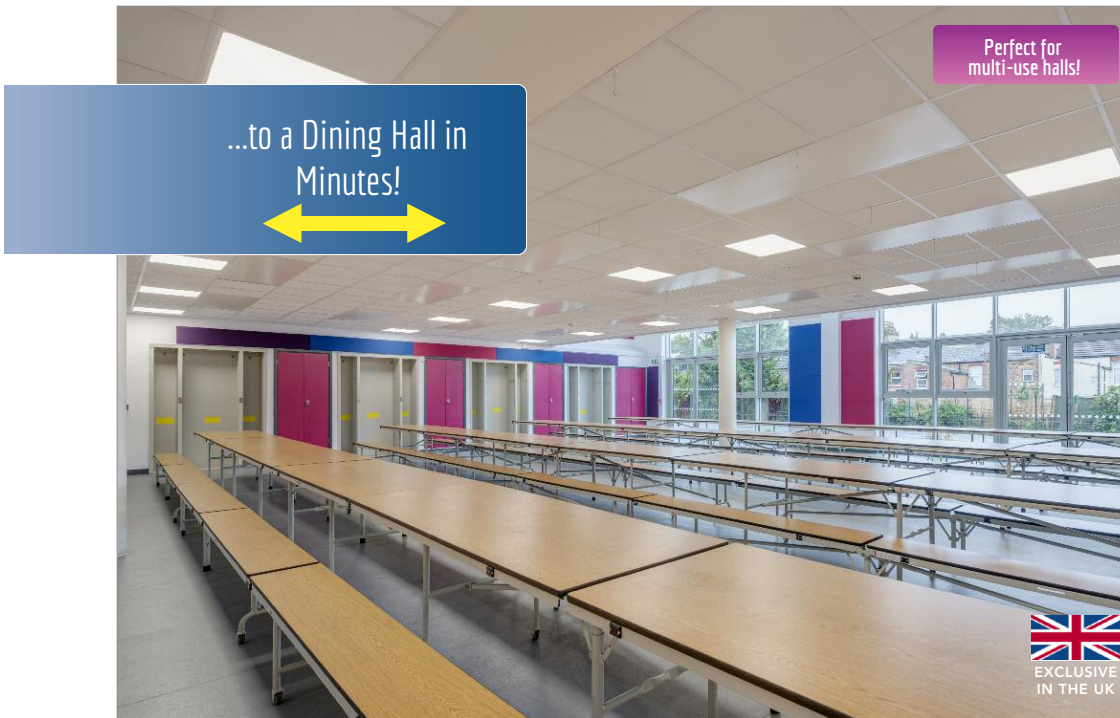

...to a Dining Hall in
Minutes!



Perfect for
multi-use halls!



EXCLUSIVE
IN THE UK

15 Year
Warranty

Wall pocket dining system

The perfect answer to dining furniture in multi-use school halls!

The space-saver wall pocket tables are the best solution for schools that use their halls for PE, dining and assemblies as these tables simply fold away into the walls when not in use. Seating up to 20 children per table, the wall pocket table folds down when required and it takes just seconds to convert your hall into a full dining facility.

When finished they fold away taking up less than 2½ square feet of floor space!

- Secure locks and counter-balance sprung for safety and control
- Benches and tables can be used independently for assemblies, community use, tabletop sales and lectures
- Pocket storage unit available as surface mounted or flush fitting for optimum space efficiency
- Optional filler panels between multiple units create a flat safe surface, facilitating multi-use activities
- Available as single, double, triple and quadruple pockets for up to 4 tables and 8 benches in one pocket!
- Special 'EdgeGuard' finish to table top for hygiene, strength and long life
- 15 year manufacturer's warranty
- Call for free survey, references and quote
- Customise your table tops with your school logo

Best Seller



A

Must be stacked vertically

When ordering your tables and benches please specify:
1. length 2. height 3. laminate colour



B

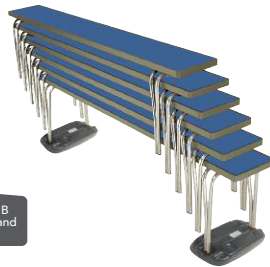

We recommend using B on page 171 for safe and easy transportation

Bench & Table Heights

When ordering, please add the height code (A-I)
e.g. code Y14014 would be Y14014B for the 698mm height.

Table heights and codes:		Bench heights and codes:	
A Buffet	760mm (30")	G Buffet	483mm (19")
B Adult	698mm (27.5")	H Adult	432mm (17")
C Junior	635mm (25")	I Junior	381mm (15")
D Infant	584mm (23")		
E PreSchool	546mm (21.5")		
F Nursery	508mm (20")		

A. Ultimate tables with polyedge™

The Premier range of folding tables features the superb polyurethane edge. The table top surface is durable, hygienic and of the highest quality.

- Suitable for dining, social gatherings, and community use
- Folds flat for storage and is easily transported, enabling this product to be used in a multi-functional environment
- Strong in construction, all 760mm and 685mm high tables are supplied with aluminium clad steel legs for stability
- Select the height of table you require from 6 heights
- 4 table lengths available 92cm, 122cm, 152cm, 183cm
- 3 table widths available 61cm, 69cm 76cm
- 17 colours to choose from

Premier folding tables

	Length		Width		Approx weight kg
	mm	Inches	mm	Inches	
Y14014*	915	36	610	24	9.00
Y14016*	915	36	685	27	9.75
Y14018	915	36	760	30	12.00
Y14020	1220	48	610	24	11.25
Y14022	1220	48	685	27	12.75
Y14024	1220	48	760	30	13.00
Y14026	1520	60	610	24	15.25
Y14028	1520	60	685	27	16.50
Y14030	1520	60	760	30	17.25
Y14032	1830	72	610	24	17.50
Y14034	1830	72	685	27	18.75
Y14036	1830	72	760	30	19.50
Y14038	FastFold Speedy Folding Tool				

* Not available in height size A

B. Ultimate stacking benches with polyedge™

- Stacking benches feature the superb polyurethane smooth sealed edge for ultimate hygiene and easy cleaning
- These benches are of the highest quality and when combined with a Premier table they transform any dining area or canteen
- A popular alternative to stacking chairs
- Available in 3 lengths 122cm, 152cm 183cm, and 3 heights 48cm, 43cm, 38cm
- Strong and robust, durable and hygienic
- Stacks for storage - use the Bench Skate Set comprising two ABS plastic moulded skates, to move your stack of benches with ease

Premier folding benches

	Length		Width		Approx weight kg
	mm	Inches	mm	Inches	
Y14002	1220	48	254	10	6.25
Y14004	1520	60	254	10	7.00
Y14005	1830	72	254	10	8.80
Y14008	Bench Skate Set				3.00

Colour Options

When ordering your tables and benches please specify:
1. length 2. height 3. laminate colour (see opposite page)

A. Concept folding tables and stacking benches

- The Concept range of folding tables and stacking benches are recommended for Dining & Canteen Halls, Youth Organisations and Outdoor Catering
- Lightweight and versatile, with a wide range of sizes available

Best Seller

Must be stacked vertically

Concept folding tables

	Length		Width		Approx weight kg
	mm	Inches	mm	Inches	
Y14040	915	36	610	24	6.75
Y14042	915	36	690	27	7.25
Y14044	915	36	760	30	7.25
Y14046	1220	48	610	24	8.00
Y14048	1220	48	690	27	8.25
Y14050	1220	48	760	30	9.50
Y14052	1520	60	610	24	9.75
Y14054	1520	60	690	27	10.25
Y14056	1520	60	760	30	11.25
Y14058	1830	72	480	19	11.00
Y14060	1830	72	610	24	11.50
Y14062	1830	72	690	27	12.00
Y14064	1830	72	760	30	13.00
Y14038	FastFold Speedy Folding Tool				

Concept folding benches

	Length		Width		Approx weight kg
	mm	Inches	mm	Inches	
Y14066	1220	48	254	10	5.00
Y14068	1520	60	254	10	5.75
Y14070	1830	72	254	10	6.75
Y14008	Bench Skate Set				3.00

When ordering your tables and benches please specify:
1. length 2. height 3. laminate colour



We recommend using B on page 171 for safe and easy transportation

Bench & Table Heights

When ordering, please add the height code (A-I)
e.g. code Y14014 would be Y14014B for the 698mm height.

Table heights and codes:		Bench heights and codes:	
A	Buffet 760mm (30")	G	Buffet 483mm (19")
B	Adult 698mm (27.5")	H	Adult 432mm (17")
C	Junior 635mm (25")	I	Junior 381mm (15")
D	Infant 584mm (23")		
E	PreSchool 546mm (21.5")		
F	Nursery 508mm (20")		



Phone
For Bulk
Prices

Colour
Options
Choose
1. table diameter
2. table height
3. laminate colour see page 170

A. Round folding tables

- The Round folding tables and stacking benches are recommended for school dining, from pre-school up to adult use
- Easy to carry and open with a simple to fold clasp the tables are strong and robust, folding flat for storage
- A wide range of sizes available with 14 choices of laminate and sealed ply see page 170



Storage
Trolley

Round Folding Tables

	Table diameter	Table Finish	Approx weight	A Buffet 76cm (30")	B Adult 70cm (27.5")	C Junior 64cm (25")	D Infant 58cm (23")	E PreSchool 55cm (21.5")	F Nursery 51cm (20")
Y14072	4ft Round	122cm	Laminate	20.00kg	•	•	•	•	•
Y14074	5ft Round	152cm	Laminate	27.50kg	•	•			
Y14078	Storage Trolley								



B. Trolley

- Table trolleys in 2 sizes to suit all needs
- Takes up to 14 tables through a standard doorway for easy storage
- Locking castors for safety

Y14010	Up to 7 Tables	each
Y14012	Up to 14 Tables	each

Only use the products on
pages 169-171 with
these trolleys

Fresco

Fresco indoor tables and benches are revolutionary in their design and construction. The special design means they are strong, robust and stable yet incredibly light and durable making them perfect for canteens, cafes and dining areas. Fresco tables and benches are delivered flat packed and require simple assembly using an allen key.

A. Fresco dining benches & tables

- Available in 8 top colours and 6 edge colours
- Strong, stable and very durable
- Also available in 900 & 1200mm round
- Ideal for educational use
- 3 bench sizes and 6 heights
- Table heights: 71cm, 64cm, 59cm
- Bench heights: 46cm, 43cm, 38cm, 35cm, 31cm, 26cm
- Please specify height when ordering
- Powder coated black and grey frame available

Benches

Code	Size l x w	Weight Kg
YDENDF35	100 x 33cm	8.00
YDENC35	120 x 33cm	10.00
YDENAF35	160 x 33cm	12.00

Tables

YDENDA35	120 x 75cm	17.50
YDENCA35	140 x 75cm	19.50
YDENAA35	180 x 75cm	25.00

Dining colour range

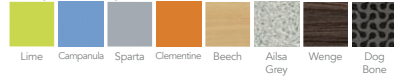

Plastic & Metal codes can be found from page 8 onwards

B. Fresco outdoor benches & tables

- Perfect for playgrounds, dining or outdoor learning
- Mahogany look synthetic wood with silver anodised aluminium frames
- Benches fit neatly under the tables for storage
- Available in 3 heights: 43cm, 38cm or 35cm
- Please specify height when ordering

Benches

Code	Size l x w	Weight Kg
YDENDF36OD	105 x 33cm	8.5
YDENAF36OD	160 x 33cm	13

Tables

YDENDE36OD	125 x 90cm	18.75
YDENDD36OD	125 x 125cm	27.0
YDENAE36OD	180 x 90cm	27.0



A



Fresco benches are easily assembled using an allen key



Anodised Silver Frame

Edge colours

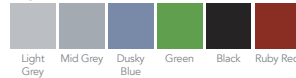

B



10 Year Warranty



Stacks up to 25 high using dolly

Frame Options



* Colours depicted are only a guide. For an exact swatch sample or alternative colour please call us to discuss your requirements.
* Black seat shell only available in sizes 380, 430 & 460mm.

A. Atlas skid base chair



- An extremely strong yet compact chair
- Ideal for use in school halls or where space is limited
- Linking attachment available

Code	Seat Height	Overall Width
Y16500	260mm	370mm
Y16501	310mm	370mm
Y16502	350mm	410mm
Y16503	380mm	460mm
Y16504	430mm	460mm
Y16505	460mm	460mm
Y16506	Dolly for Atlas Skid Base Chair	
Y16507	Linking Attachment	

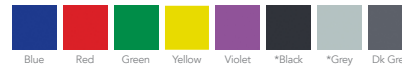

6 Year Warranty



B. The Profile chair



- Modern contoured style
- Meets EN1729 Parts 1 & 2
- Can be stacked 8 high with great stability
- Orders of less than 10 chairs may carry a carriage charge

Code	Details	Seat Height	Width
Y100186	4 Legged Chair	430	480
Y100187	4 Legged Chair	460	480
Y100188	Skid Base Chair	430	530
Y100189	Skid Base Chair	460	530
Y100190	Cantilever Chair	430	530
Y100191	Cantilever Chair	460	530
Y100192	Optional Seat Pad	POA	

Shell colours:

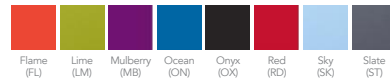

Frame colours

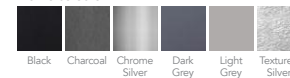

Plastic & Metal codes can be found from page 8 onwards

New Product



Back colour options



C. SE Plywood

- This version takes the incredibly comfortable backs of the SE Classic and Curve chairs and adds a beautifully crafted plywood seat section. The result is an incredibly comfortable, durable and affordable option for café, bistro, breakout and office areas, with a great range of colours and wood finishes.

	Seat Height
SEC5 Side Chair - 4 Leg Frame	430mm
SEC6 Side Chair - Skid Frame	460mm

Plywood seat options



Frame colours



A



2 Year Warranty

A. Tuscany polypropylene dining chair & stool

- The Tuscany brings a modern, lively look to dining and study areas, whilst the strong polypropylene seat and chrome frame are very wear resistant
- Available in 16 distinctive colours
- Stackable
- 2 year warranty

		Seat Height
YD565	Chair	460mm
YD566	Stool	760mm

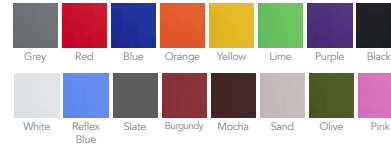

B



B. Freeway dining chair and stool

- Freeway combines durability, comfort and style in one refined chair
- Available in 9 vibrant colours and 2 heights
- Manufactured with a 12mm quality plyform shell for longevity

		Seat Height
Y360350	Dining Chair	460mm
Y360351	Dining Stool	750mm

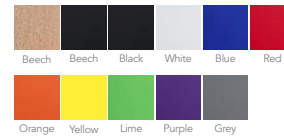

Plastic & Metal codes can be found from page 8 onwards

New Product

C



C. Curve dining chair & stool

- The Curve shell shape offers optimum comfort and practicality for your dining areas
- Steel 4 leg frame with stylish chrome plated finish. Also available with skid frame
- Polypropylene, wipe clean shell. Easy to clean and sanitise
- Stackable design ideal for storage in high-use dining areas
- Available in four colours

		Seat Height
Y360802	4 Leg Frame	450mm
Y360804	Skid Frame	450mm
Y360806	High Stool	760mm



A. Flow dining chair

A robust, durable and extremely popular chair which will work hard in your dining room giving years of dependable service. The iconic shape and chrome frame looks great and the angled rear legs discourage tilting.

- Available in 16 colours
- Stacks 6 high
- 15 year warranty for complete peace of mind
- Seat height 460mm

		Seat Height
Y360124	Chrome Frame	460mm
Y366326	Silver Frame	460mm

For critical colour matching please ask for a sample

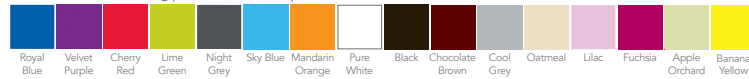

New Silver Frame Option

A

B. Polka dining chair

- Bring a vibrant pop of fun to your dining area with the Polka chair and give your students something to shout about!
- Amazingly strong, ergonomic design tested to EN1729 to give an improved dining experience for students
- Stackable, stable design, which is hard to tilt
- Available in 8 colours
- Frame colours are Black, Light Grey, Dark Grey, Silver, Chrome

	Seat Height	Width
Y360128	430mm	490mm
Y360129	460mm	490mm



B

C. Poly Side Chair

- The La Rocca chair is guaranteed to bring an urban look to your dining hall with its striking elegant design
- This affordable chair is one of the strongest polypropylene chairs on the market with a steel frame that extends up the back of the chair
- Available in 4 shell colours
- Frame colours are Black or Chrome
- UK made with a 10-year guarantee

	Seat Height	Width
Y360130	440mm	463mm

Top colours



Flame Blue Light Grey Charcoal

Frame colours



Matt Black Chrome



C

Plastic & Metal codes can be found from page 8 onwards

A. Seattle

- The Seattle conference chair with it's slim profile is a subtle addition to the modern workspace.
- Stackable up to 4 high, the practical design makes it a flexible option for conferences, breakout spaces or canteens. The choice of tones add subtle colour with a plastic finish that makes this chair easy to sanitise.

		Seat Height
SCSFP	4 Leg Side Chair	450mm
SCSLP	Skid Side Chair	450mm

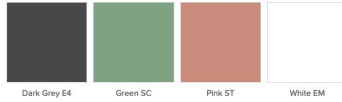

New Product

B. Palermo chair

- Ideal for breakout areas and canteens the Palermo chair's contemporary moulded shape and subtle muted colour choice bring vitality to any workspace.
- Choose the standard form or with integrated armrests.
- both stackable up to 4 chairs high. The solid plastic finish makes them easy to keep clean.

		Seat Height
SCPFP	Oslo Dining Chair	465mm



New Product

C. Apero Bench Seat

Our Apero Fast Food unit uses the incredibly comfortable ergonomic shell from the Pepperpot chairs to create a more welcoming fixed seating unit.

Available in 2 seater, 4 seater single access and 4 seater double access, the Apero Fast Food unit allows you to create a suitable layout for any situation.

Units can be floor fixed or freestanding, with a good range of colour options.

		Seat Height
4S/2U	Dining Chair	430mm

Shell colours



Frame colours



Plastic & Metal codes can be found from page 8 onwards



A. Stanza café chair

Looking for a little chic? You've definitely got it with Stanza!

- No screws, joints or pressure points
- Designed for maximum comfort & good lumbar support
- Made from reinforced Polypropylene with a lightly textured polymer finish
- Lightweight and easy to handle
- Easy clean and resilient
- Stacks up to 10 high
- Interior and Exterior use - UV resistant
- Available in 10 dynamic colours

	Seat Height
YD995 Stanza Café Chair	460mm



Plastic & Metal codes can be found from page 8 onwards

B. Veneto dining chair

- Holiday culture? You've definitely got it in these sleek black chairs, sure to bring an Italian alfresco feel to your dining area
- Intended for outdoor use but also work well indoors
- Maintenance-free wood effect for all the looks & no hassle
- Strong aluminium welded frame
- Stackable to 6 chairs
- Shown in Black and Brown wood effect, also available in real teak

	Seat Height
Y360140 Veneto	455mm
Y366327 Veneto Armchair	455mm

C. Seville café armchair

- The Seville Cafe black polypropylene and aluminium bistro chair is ideal for all eating, informal conferencing and sixth form areas providing a durable and cost effective solution
- Indoor and outdoor use
- Fully welded frame for maximum strength with no screws or bolts to come loose

	Seat Height
YD624 Seville Cafe Armchair	445mm

D. Café - table

- These cafe tables are suitable for either internal or external use matching our other aluminium furniture
- The tables are robust and strong for use in student areas
- The easy to clean tops and 2 year guarantee ensure these tables provide outstanding value for money
- Larger tables also available

Y16476	Cafe Round Table
--------	------------------

Also available with a Seat Pad



A



Matching tables available as shown

Also available in brown wood-effect



B



C



D

2 Year Maker's Guarantee

Phone For Bulk Prices



A

A. Metallique side chair

- Wanting to create a 'Costa style' dining area? The vintage Metallique range provides just that!
- Shown in Gunmetal, also available in Silver and Copper
- Low stool and high stool (without back) also available

		Seat Height
Y366328	Side Chair	450mm
Y366329	High Chair	745mm



B

B. Spar dining chair

- With its iconic retro style and strong polyurethane seat the Spar chair will bring style and character to your dining space
- Available in 10 modern colours
- New mid height stool for 2019

		Seat Height
YD102	Chair	450mm
Y366325	Chair Skid Frame	450mm
Y366324	Mid Stool	695mm



C

C. Strata dining chair

- These sleek and designer style dining chairs add a great element of style to your dining room and you have a choice of the minimalist 4 leg or the sophisticated spar design leg frame
- Made of tough polypropylene with chrome steel frames, these chairs are designed to last as well as looking good every day
- Available in 9 modern colours

		Seat Height
Y360112	Four Leg	450mm
Y360114	Sparleg	450mm



A. Skagen dining chair & stool

- With a nod towards Scandinavian style, the distinctive Skagen range combines wood and steel to create a robust and elegant addition to your dining area
- Available in Black or Natural
- Available in 3 dining heights

	Seat Height
Y366318 Dining Chair, Ash	480mm
Y366338 Dining Chair, Black	480mm
Y366319 Mid Stool, Ash	650mm
Y366339 Mid Stool, Black	650mm
Y366320 High Stool, Ash	650mm
Y366340 High Stool, Black	750mm



A

B. Ermington dining chair

- The Ermington adds a sophisticated look to any dining area with its one-piece shell and chrome frame
- 4-leg Chrome version stacks up to 6
- Frames in Steel or Chrome
- Maple Veneer

	Seat Height
YD303 Dining Chair	460mm
Y366321 Chrome Spar Chair	460mm
Y366322 Black Spar Chair	460mm



Please see page 273 for wooden frame options

B

C. Plus & Minus Stool

- The Plus & Minus bar stool range is a result of a chance meeting with award winning designer Alexander Hay at a London design show. The range had been prototyped and immediately grabbed our attention and we felt we had to bring it to the market.
- The combination of beautiful crafted solid red oak tops, carrying the plus or minus detail and the creative simplicity of the frame make a striking option as a bar or breakfast stool.

	Seat Height
PM1 Dining Chair	450mm
PM2 Dining Stool	650mm
PM3 Dining Stool	780mm

Frame colours

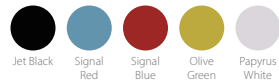

C

Barletta café dining tables

- These robust and elegant tables look great in any dining setting and are sure to add a café feel in any dining area
- Heavy bases ensure good stability in high footfall areas
- 25mm thick MFC core top with impact resistant edge
- Easy clean surface
- For ultimate durability why not upgrade to the Werzalit table tops – please ask for more details



Other colours & sizes available to order



Square Base, Square Top



Rectangular Base, Rectangular Top



Trumpet Base, Round Top



4-Leg Base, Square Top



Flip Top, 4-Leg Base, Square Top



Flip Top Tables



Flip Top, 4-Leg Base, Round Top

Top Colours

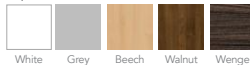

Wood & Metal codes can be found from page 8 onwards

Black Cast Square Dining Base

- Y370110 600mm with 600mm Square Top
- Y370112 700mm with 700mm Square Top
- Y370114 800mm with 800mm Square Top

Black Cast Rectangular Dining Base

- Y370116 1200mm with 700mm Rectangular Top
- Y370118 1500mm with 700mm Rectangular Top

Black Cast Trumpet Dining Base

- Y370120 600 diameter Round Top
- Y370122 700 diameter Round Top
- Y370124 800 diameter Round Top

Chrome Trumpet Dining Base

- Y370126 600mm with 600mm Square Top
- Y370128 700mm with 700mm Square Top
- Y370130 800mm with 800mm Square Top

- Y370132 600 diameter Round Top

- Y370134 700 diameter Round Top

- Y370136 800 diameter Round Top

Stainless Steel Square Dining Base

- Y370138 600mm with 600mm Square Top
- Y370140 700mm with 700mm Square Top
- Y370142 800mm with 800mm Square Top

Stainless Steel Rectangular Dining Base

- Y370144 1200mm with 700mm Rectangular Top
- Y370146 1500mm with 700mm Rectangular Top

Stainless Steel Trumpet Dining Base

- Y370148 600 diameter Round Top
- Y370150 700 diameter Round Top
- Y370152 800 diameter Round Top

Aluminium Spar 4-Leg Dining Base

- Y370154 600mm with 600mm Square Top
- Y370156 700mm with 700mm Square Top
- Y370158 800mm with 800mm Square Top

- Y370160 600 diameter Round Top

- Y370162 700 diameter Round Top

- Y370164 800 diameter Round Top

Flip-top range

- Y370166 600mm with 600mm Square Top

- Y370168 700mm with 700mm Square Top

- Y370170 800mm with 800mm Square Top

- Y370172 600 diameter Round Top

- Y370174 700 diameter Round Top

- Y370176 800 diameter Round Top

Palermo café dining tables

- With a wide selection of tables available, this range offers choice and versatility.
- The Palermo café dining range allows schools to create flexible and multi-functional dining environments.
- A strong metal underframe provides enhanced strength and stability
- Height adjustable feet

Square

	H x L x Dmm
Y370200	725 x 660 x 660

Rectangular

	H x L x Dmm
Y370210	725 x 1200 x 800
Y370212	725 x 1400 x 800
Y370214	725 x 1600 x 800

Semi Circular

	H x L x Dmm
Y370216	725 x 1600 x 800

Trapezoidal

	H x L x D x Dmm
Y370218	725 x 1412 x 740 x 800 (22.5 degree)
Y370220	725 x 1600 x 693 x 800 (30 degree)

Wood finishes are heat, stain and scratch resistant when used for their intended purposes.

Metal finishes



Silver Grey

Wood finishes



Birch Maple Walnut White Beech Light Oak

Wood & Metal codes can be found from page 8 onwards





Leg Finishes

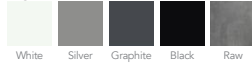

MFC Finishes

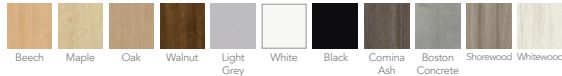

Wood & Metal codes can be found from page 8 onwards

A. Statik hoop dining range

- The Statik Hoop dining range is a contemporary yet practical solution for modern dining environments
- Fully welded frame construction with 40mm thick tops and high impact resistant edges
- Easy clean laminate surfaces
- Benches store neatly under the tables for compact storage
- Many colour options available - please ask
- Upholstered seats available at extra cost

Benches

Y360418	H425 x L1000 x D350mm
Y360420	H425 x L1200 x D350mm
Y360422	H425 x L1400 x D350mm
Y360424	H425 x L1600 x D350mm
Y360426	H425 x L1800 x D350mm
Y360428	H425 x L2000 x D350mm

Tables

Y360400	H750 x L1200 x D800mm
Y360402	H750 x L1400 x D800mm
Y360404	H750 x L1600 x D800mm
Y360406	H750 x L1800 x D800mm
Y360408	H750 x L2000 x D800mm
Y360410	H750 x L2200 x D800mm

Poseur Tables

Y360412	H1000 x L1600 x D800mm
Y360414	H1000 x L1800 x D800mm
Y360416	H1000 x L2000 x D800mm

A. Statik bold dining range

- The Statik Bold range is a hard-wearing yet stylish choice for the modern dining room
- Heavy duty construction made with 40mm laminate and high impact resistant edges
- Easy clean laminate surfaces
- Benches store neatly under the tables for compact storage
- Many colour options available - please ask

Statik Bold Bench

Y360430	H425 x L1200 x D350mm
Y360432	H425 x L1400 x D350mm
Y360434	H425 x L1600 x D350mm
Y360436	H425 x L1800 x D350mm
Y360438	H425 x L2000 x D350mm
Y360440	H425 x L2200 x D350mm

Statik Bold Table

Y360442	H750 x L1200 x D800mm
Y360444	H750 x L1400 x D800mm
Y360446	H750 x L1600 x D800mm
Y360448	H750 x L1800 x D800mm
Y360450	H750 x L2000 x D800mm
Y360452	H750 x L2200 x D800mm

Statik Bold Poseur Table

Y360454	H1000 x L1600 x D800mm
Y360456	H1000 x L1800 x D800mm
Y360458	H1000 x L2000 x D800mm



Dining screens & queue barriers

Create the perfect setting in your dining hall using our wide range of smart screens. Robust and designed to last, these screens will help control student traffic flows and achieve the right ambience in any eating or reception area.

- Strong and stable for safety and durability
- Available in different sizes and colours for any application
- Wide, stable feet and linking strips for flexibility
- Re-configure your hall for a special event in seconds
- Free space plan service - just ask!

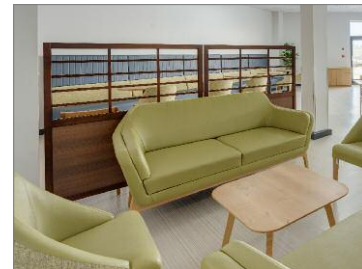



Needing to cater for everyone in your library?
We can beautifully display your books and store those resources - whilst creating areas for relaxed reading and inspiring learning areas.



SPACES TAYLORED

Libraries & Learning Zones

Library Design	186 -187
Dynamix Shelving	188
Cantilever Shelving	189
Coniston Shelving	190
Grasmere Book Storage	190
Lundy Island Units	191
Classroom Steps	192
Book Storage	191-194
Kandi Range	195
Easy Modular	196-203
Seating Study Hubs	202-203

[Main Content Page](#)

Libraries & Learning Zones

Libraries are fast becoming much more than just a place to display books. With the rise of self-directed learning and personalised study programmes, libraries and learning zones are often the central feature of the school.

From group activities right through to individual study we have a full range of furniture, shelving and seating to create the perfect environment for you.

Whether its bespoke or from stock, you'll be amazed at the ideas we'll come up with based on solid experience combined with creativity and design flair. Zones to take your breath away!





More Than Just Library Design

Don't forget, our design service is free for reading corners, classrooms and whole school fit outs too. We're happy to do all of the hard work and when it comes to bringing brilliant design to your school we go the extra mile. Whatever your requirement, talk to us today for a free, no obligation design.

You're In Safe Hands

Our market leading range of educational furniture has been developed working directly with schools and by our own team of experienced in house designers. No matter how big or small your Library or Classroom project may be, we can create the perfect learning space. Our team will meet you at your school when possible to take measurements and start the design process. Alternatively try our remote design process for even faster results.

You're In Safe Hands

Our market leading range of educational furniture has been developed working directly with schools and by our own team of experienced in house designers. No matter how big or small your Library or Classroom project may be, we can create the perfect learning space. Our team will meet you at your school when possible to take measurements and start the design process. Alternatively try our remote design process for even faster results.

More Than Just Library Design

Don't forget, our design service is free for reading corners, classrooms and whole school fit outs too. We're happy to do all of the hard work and when it comes to bringing brilliant design to your school we go the extra mile. Whatever your requirement, talk to us today for a free, no obligation design.

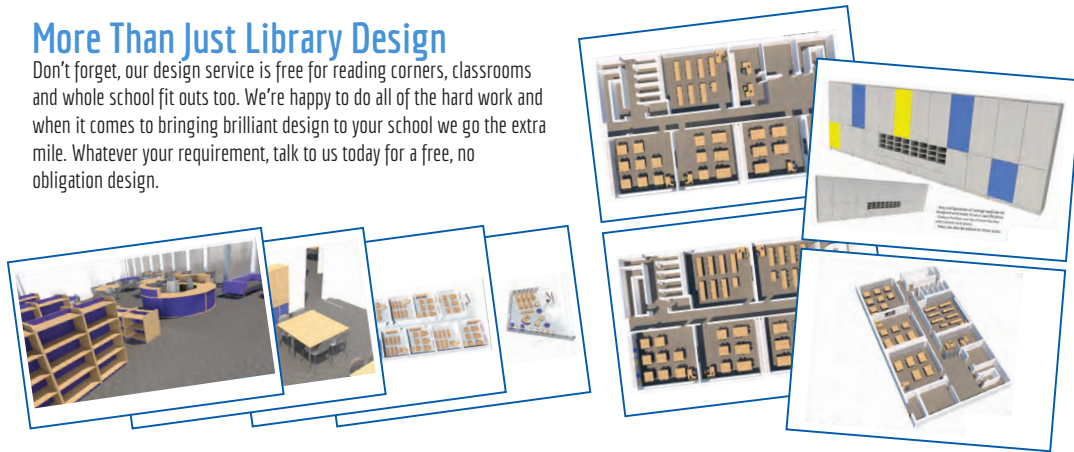

Dynamix Library System



Stunning units with coloured edges and tops, the dynamix range creates an impressive and stimulating library and learning environment.

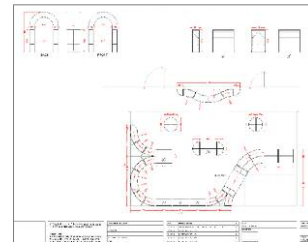
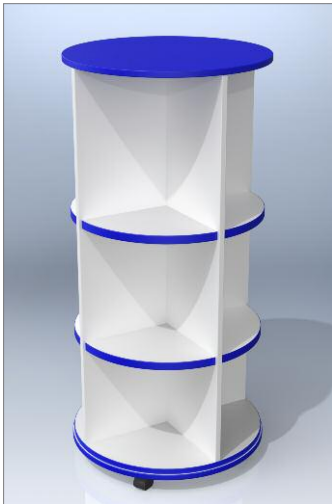
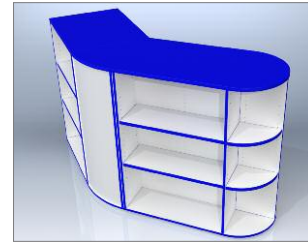



Cantilever Shelving

- This versatile shelving system offers a wide range of shelves and accessories - ideal for all library and office requirements
- Modern and stylish, this system can be quickly adapted to meet your changing needs
- Space planning and fitting also available
- The system is quick and easy to construct saving down time and minimising disturbance
- End bays and tops can be clad with timber facing, to match existing desking, or panelling to your specification

CONTACT US TO
DISCUSS YOUR
SHELVING
REQUIREMENTS

Coniston Library Shelving

Coniston is a high quality range of shelving units, available in a choice of 8 colours, specifically designed to create practical and aesthetically pleasing learning environments.

- All units can be supplied in one colour or a combination, as shown
- Units can also be supplied with castors
- Available as single or double sided units and also starter units and add-on units to create a neat and uniform library area
- Complete with 5 year guarantee



Wood & colour finishes may not be representative of actual colours - please ask for a sample



Grasmere Curve Book Storage System

- Premium range made from high quality 18mm MFC in a choice of board finishes with cream back boards
- Choice of either single sided bookcases in 2 heights, or double sided mobile units in 3 different heights
- Other board finishes available - please ask for pricing and details

Wood & colour finishes may not be representative of actual colours - please ask for a sample



A. Grasmere straight bookcase

- Single sided
- Depth 320mm

	H x W (mm)
Y200600	900 x 1000
Y200604	900 x 600



B. Grasmere straight bookcase

- Double sided
- Depth 600mm

	H x W (mm)
Y200610	900 x 1000
Y200612	1200 x 1000
Y200614	1500 x 1000
Y200616	900 x 600
Y200618	1200 x 600
Y200620	1500 x 600



C. Grasmere curved bookcase

- Single sided
- Choice of concave - curves inwards or convex - curves outwards
- Max. depth 835, width 1180mm

	H (mm)
Y200630	Convex 900
Y200632	Concave 900
Y200634	Convex 1200
Y200636	Concave 1200



D. Grasmere curved bookcase

- Double sided
- Max. depth 1115 x width 1575mm

	H (mm)
Y200640	Convex 900
Y200642	Convex 1200
Y200644	Convex 1500
Y200646	Concave 900
Y200648	Concave 1200
Y200650	Concave 1500

Lundy Library Units

This range of island book and tray storage is designed to be used with the quadrant storage tray.

Quadrant storage trays are available in red, blue, green or transparent and deep trays are available in a choice of colours – see page 50.

An optional cushion is available to maximise the uses of this range – cushions are available in red, blue, yellow or green fabric or vinyl.



Page Link - see pages

For waterfall units...

193



Book/tray storage unit

Y300CT8	1 Tray High W372 x D431 x H660
Y400CT8	2 Trays High W372 x D431 x H840
Y550CT8	3 Trays High W372 x D431 x H1020



Book seat storage

- Optional cushion available

Y300CT10	1 Tray High W372 x D1217 x H266
Y400CT10	2 Trays High W372 x D1217 x H463
Y550CT10	3 Trays High W372 x D1217 x H661

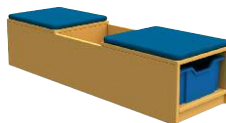

Island unit

- Optional cushion available

Y300CT9	1 Tray High W1252 x D1216 x H266
Y400CT9	2 Trays High W1252 x D1216 x H463
Y550CT9	3 Trays High W1252 x D1216 x H661



Book & seat storage island

- Optional cushion available

Y300CT11	1 Tray High W1217 x D862 x H660
Y400CT11	2 Trays High W1217 x D862 x H840
Y550CT11	3 Trays High W1217 x D862 x H1020



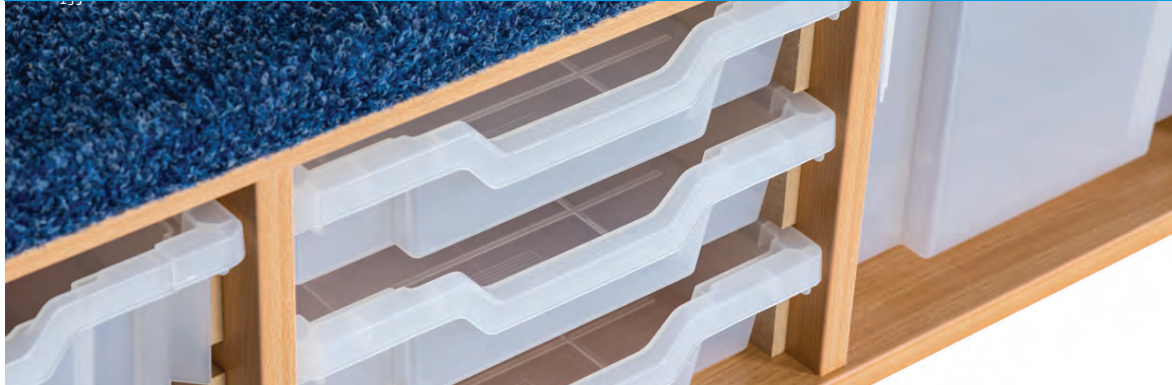

Premium Classroom Steps

High quality, secure & strong classroom steps used in front of your active whiteboards to aid younger pupils to reach the screen & participate in front of the class.

Supplied with Gratnells trays in a choice of colours.

Each step is built using a high quality, 18mm solid wood MDF in a choice of finishes. A durable navy blue carpet is fitted to the top.



Classroom Step - includes 2 x Deep & 2 x Shallow trays		
A18001	H250mm x W1025mm x D500mm	

**250mm
HIGH**



Classroom Step - includes 2 x Extra Deep & 3 x Shallow trays		
A18002	H335mm x W1025mm x D500mm	

**335mm
HIGH**



Classroom Step - includes 2 x Deep & 4 x Shallow trays		
A18003	H250mm x W1355mm x D500mm	

**250mm
HIGH**



Classroom Step - includes 2 x Extra Deep & 6 x Shallow trays		
A18004	H335mm x W1355mm x D500mm	

**335mm
HIGH**

Choice of colour finishes





A

A. Tiered shelf library unit

- In a choice of Beech-BE, or Maple-MP MFC finish
- Dimensions: W760 x D380mm
- 4 tier H780mm, 5 tier H965mm

Y15092 4 Tier Unit

Y15094 5 Tier Unit



B

B. Straight shelf library unit

- In a choice of Beech-BE, or Maple-MP MFC finish
- Dimensions: W1040 x D502mm
- 3 tier H1000mm, 4 tier H1500mm

Y15096 3 Tier Unit

Y15098 4 Tier Unit



C

C. 2 & 3 shelf library units

- Popular double sided Beech units
- 2 shelf unit has 2 angled display shelves each side, and a flat storage shelf
- The 3 shelf unit has 3 flat storage shelves either side
- W1040 x D500 x H850mm

Y15106 2 Shelf Unit

Y15114 3 Shelf Unit



D

D. Hanging big book storage unit

- Ideal storage for big books and group readers
- Attractive beech wood finish
- Double hanging rail to accommodate all sizes

YTG01 Hanging Big Book Storage Unit



A. Book spinner

- This smaller version of an adult paperback tower holds 125 books or 60 videos
- The tower and base can be chosen in two different colours to create your own multi-coloured unit
- Please specify the base and tower colours when ordering the coloured book spinner
- Size: W400 x D400 x H1350mm
- Internal slot height: 220mm
- Dimensions for book space between dividers: 115 x 115mm

Y15110 Book Spinner Beech

Y15112 Book Spinner Coloured



A



B. Big book holder

- Beech melamine unit stores books vertically in six slots
- Available with castors or as pictured
- W695 x D504 x H600mm

Y15108 Big Book Holder Mobile

Y15109 Big Book Holder Static



B

C. 4 legged kinderbox

- Wooden or metal 4 legged frame 4 kinderbox unit
- Boxes available in beech, red, green, yellow or blue finish
- Wooden frame: D620 x W620 x H360mm
- Metal frame: D600 x W600 x H360mm
- Bespoke sizes and shapes available

YBX05W Wooden Frame Kinderbox

YBX05M Metal Frame Kinderbox



C



Kandi

The Kandi range allows you to create an instant library or reading corner in any space. Mix and match units to create immersive student areas. Available in 7 bright colours and 2 wood finishes.

Y400100	Island Set H1500 x W1450 x D350mm
Y400102	Reading Straight Set H1500 x W1450 x D350mm
Y400104	Reading Corner Set H1500 x W1465 x D1465mm
Y400106	Book Tree Oval H1250 x W2250 x D350mm
Y400108	Book Tree Triangle H1250 x W2250 x D350mm
Y400110	Display & Browse set H1250 x W2250 x D350mm
Y400112	Display & Browse with Stools set H1250 x W2250 x D350mm
Y400114	Reading Nook H1500 x W2700 x D676mm
Y400116	Hideaway Play Nook H1250 x W1700 x D676mm
Y400118	Hideaway Double Nook H1250 x W2100 x D676mm



Y400100



Y400102



Y400104



Y400106



Y400108



Y400110



Y400112



Y400114

Kandi Colour Options



Beech Blue Orange Fuchsia Green Maple Plum Light Blue Red

Kandi Upholstery Colour Options



Apple Cobalt Blue Fuchsia Lemon Red Orange Turquoise Violet



Y400116



Y400118

Soft Seating

Neptune Modular Seating

New Neptune is a versatile range of reception / breakout seating that can be configured in many layout options. The range is available as a single cube, single wedge, double cube and double wedge.

The single and double cube can be supplied with backs, or in large configurations.

Code	Description	Overall Height	Width	Depth
420	Single	460	550/300mm	600mm
421	Double	460	1150/900mm	600mm
422	Single	460	550mm	600mm
42	Single Cub	1000	600mm	
4	Doubl	460	1150mm	600mm
42	Double Cub	1000	1150mm	600mm



420 - Single Wedge



423 - Double Cube



With back 4233

info Also available with seat height at 355mm or 385mm. Please enquire for details.



421 - Double Wedge



422

With back 4222



Neptune modular vinyl range

- A flexible range of modular seating perfect for libraries and breakout areas
- Fully upholstered modular furniture with optional vinyl
- Available in: Vinyl band 4

Please specify fabric colour

Page Link - see pages
For Laptop Tables → 247



Page Link - see page
Vinyl Colour Options → 284





Aurore

Bold and beautiful, Aurore is truly modular and specifically designed to stand up to daily use in schools. Aurore is a series of modular units which enables multiple configurations, available in a variety of fabrics.

Y400230	Large D-end Bench
Y400232	120° 1200mm Bench
Y400234	Right-hand Wave Bench
Y400236	Left-hand Wave Bench



New Product

Huddle

Huddle is a statement modular furniture collection that facilitates a multitude of ways to work via the creation of configurable and connected spaces. It is an innovative system designed to enable spaces to flex and adapt using easy to assemble modules to configure different shapes, making each space unique to the needs of the environment.

- The Huddle collection is based on four modular components: backs, benches, screens and work rails
- Available with integrated technology including power modules and WIFI
- These modules can be curved or straight and are available in a choice of widths; with or without legs
- Integral work surfaces and tables are optional
- Available in a wide range of fabrics, vinyls and leathers



Y369810 Configuration 1



Y369812 Configuration 2







Y369814 Configuration 3

Funghi Stool	size	code	fabric band B	fabric band C
	dia 400mm H540mm	FU-40/54-N2	257	273
	dia 500mm H500mm	FU-50/50-N2	276	296



Funghi

Lily Stool	height	diameter	code	fabric band B	fabric band C
	462	450	LILYOR450	285	365
	462	510	LILYOR510	292	371
	462	450	LILYORF450	455	557
	462		LILYORF510	464	562



37% average recycled content.



91% average recyclable content.



Lily

Readingzone



- Ideal for library areas, receptions, common rooms, in fact they fit anywhere!
- Seat height 440mm
- Please call for bulk discounts



Unlimited fabrics available

Prices shown are for Phoenix, Era and Rivet fabrics only - see pages 281-284. Please contact us for prices on other fabrics.



Best Seller
5 Year Warranty



Round Stool

YSTYROF* Fabric
YSTYROV* Vinyl



Square Stool

YSTYSQF* Fabric
YSTYSQV* Vinyl



Two Seater Bench

YSTY2F* Fabric
YSTY2V* Vinyl



Three Seater Bench

YSTY3F* Fabric
YSTY3V* Vinyl



Oval Stool

YSTYOVF* Fabric
YSTYOVV* Vinyl



Wedge Stool

YSTYWGF* Fabric
YSTYWGV* Vinyl

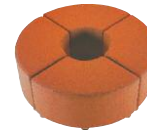

Quadrant Stool

YSTYQUF* Fabric
YSTYQUV* Vinyl



Tangent Stool

YSTYGF* Fabric
YSTYGV* Vinyl

Page Link - see page
Early Years Versions



Page Link - see page
View more styles...



For seat dimensions see pages 277-280



Stone Stool

YSTYSSF* Fabric
YSTYSSV* Vinyl



Large Island Stool

YSTYISF* Fabric
YSTYISV* Vinyl

Libraries & Learning Zones



Oasis

- Comfortable modular seating
- Optional back 530mm extension
- Endless configurations

More from this range
on pages 236-237

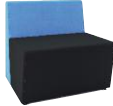

Single seater straight unit

Y600110	Single Seater
Y600115	Single Seater Back Extension



2 seater straight unit

Y600120	2 Seater
Y600125	2 Seater Back Extension



3 seater straight unit

Y600130	3 Seater
Y600135	3 Seater Back Extension



Corner unit

Y600140	Corner Unit
Y600145	Corner Unit Back Extension



T module unit

Y600150	T Module Unit
Y600155	T Module Unit Back Extension

£585.00

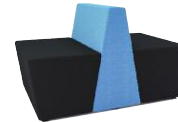

Back to back single seater

Y600160	Back to Back Single Seater
Y600165	Back Extension

Whisper



A. YWHIS1	Whisper Straight High Back Seat Unit
B. YWHIS2	Whisper 45 Degree Concave High Back Seat Unit
C. YWHIS3	Whisper 45 Degree Convex High Back Seat Unit

Colour Options Unlimited fabrics available
Prices shown are for Era and Rivet fabrics only - see pages 281-284. Please contact us for prices on other fabrics.



Causeway

- These irregular hexagonal form seats are available in two heights that serve as both sitting and backrest units
- Can be freely combined in infinite arrangements
- Ideal for chillout zones, waiting areas and entrance halls
- Connected with black, powder coated metal links

YCWAYHU	High Unit (750mm)
YCWAYLU	Low Unit (450mm)
Y400260	Side Table



Page Link - see pages

For
Laptop
Tables

247



Bean bags

- Perfect for indoor as well as outdoor use, this versatile bean bag is great for relaxed learning environments
- Tough wipe-clean waterproof fabric makes it perfect for outdoor reading
- Available in a range of bright colours
- Other fabric options available including pastel colours, quilted, fur and suede

	H x W x L(mm)
Y400900	Mini Relax Pod 740 x 740 x 710
Y400901	Mighty Relax Pod 800 x 990 x 940
Y400902	Monster Relax Pod 940 x 1160 x 800

Made from
waterproof material





Retreat - Booth



Retreat - Cube



Retreat - Curve

Retreat

Retreat is a range of acoustic work areas created to make open spaces private.

With numerous styles, configurations and a full range of accessories, Retreat can be used in many different environments.

Please contact us for more details and ask about our planning and design services.



New Product



Blox

Tiered seating – perfect for library and school environments! The Blox range offers total modularity which means that a room can be quickly and easily converted to whatever use is required, even using the units as room dividers to accommodate separate groups.

Its style and functionality are matched by its quality, comfort and durability. The Blox range is available in numerous configurations and is upholstered in a wide range of fabric, vinyl or leather – perfect for libraries and other school environments. Please contact us for more details!

Zen

The Zen range nestles and tessellates to optimise available space, allowing the creation of an agile and flexible work space. Perfect for encouraging self-directed learning amongst students, the Hive pods create a quiet space amongst the bustle ensuring optimum productivity.

Please call for more information



Raft high back

A highly versatile modular seating system, the Raft High Back range combines pleasing aesthetics with acoustic properties to create a practical and affordable learning environment solution.

See more of the range on page 236

See pages 236-237 for the full Raft high back range

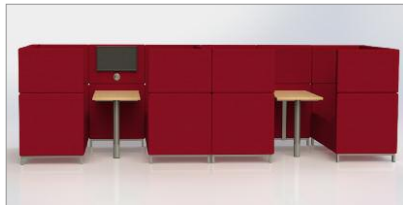

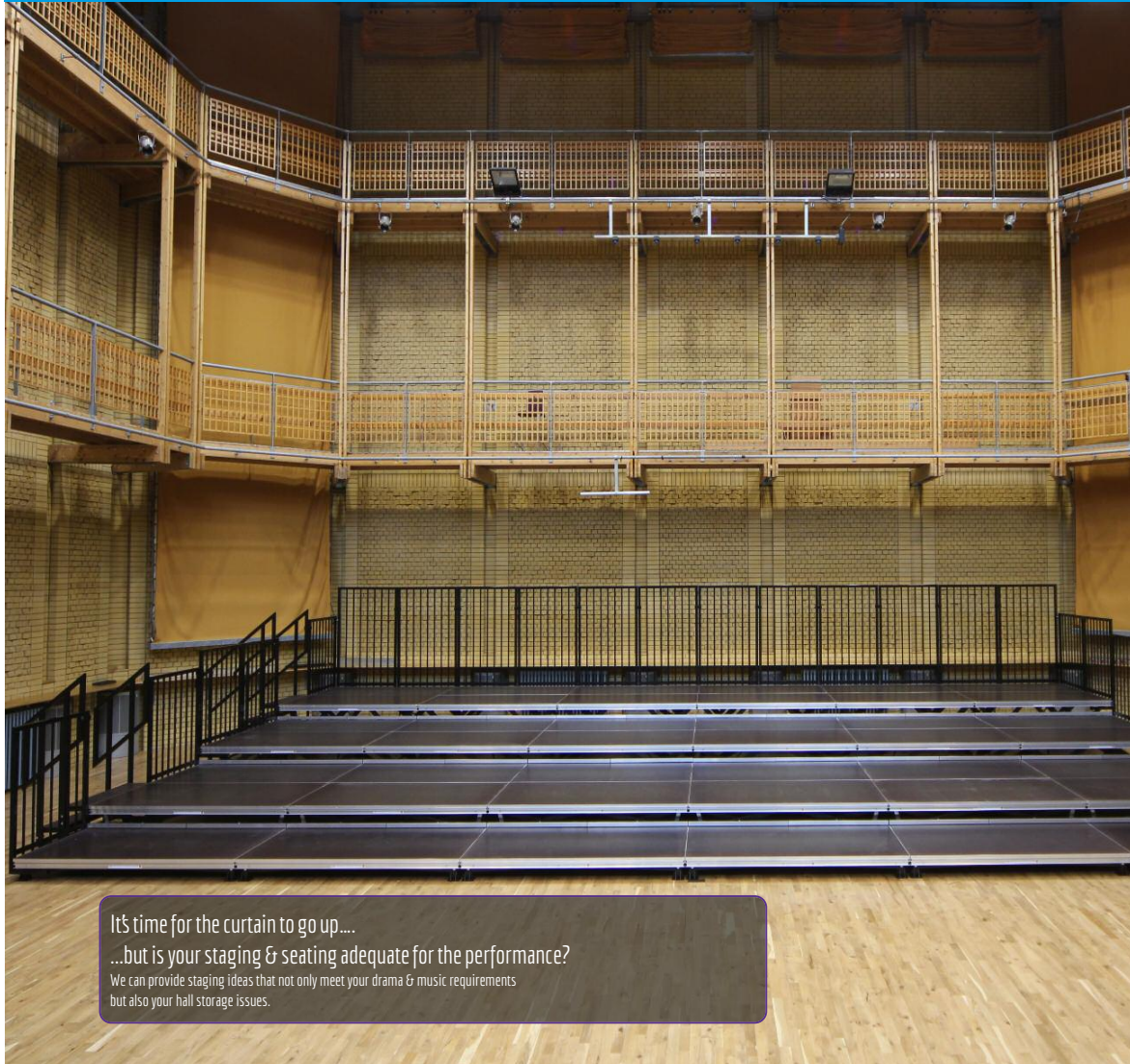

It's time for the curtain to go up...
...but is your staging & seating adequate for the performance?
We can provide staging ideas that not only meet your drama & music requirements
but also your hall storage issues.



SPACES TAYLORED

Staging & Auditorium Seating

Lite-Build	206-207
Alu Lite	208
Easi-Fold	208
Rapid-Build	209-212
Auditorium Seating	213

[Main Content Page](#)

Staging & Auditorium Seating

All children love being 'on stage' at some point in their life, whether it be for a school performance, a presentation, or just to receive a reward. It can give them a real sense of achievement and a boost to their morale, but being in an audience that can't see the action, can be very frustrating.

Is your staging adequate enough to give both performers and audience the satisfaction they deserve? Our range of staging and auditorium seating can help you achieve this by elevating the pupils or having tiered seating for the audience. Please contact us for the best solution for you.





Very compact storage

Creating amazing performance spaces...



Lite-Build Staging

Lite-Build is a simple portable stage system to meet your performance and teaching demands. Lite-Build is the lightweight solution making it very easy to handle and compact to storage, and is packed with features providing a safe and easy to use platform for all your performances. This makes Lite-Build a popular choice for use in all schools, from primary age to post-16.

10 Year
Warranty

Lite-Build Single Level Stage Packages



Lite-Build Package A

- 3 x 2.25 metres
- 12 x Stage Tops
- 12 x Stage Frames
- 1 x Step Unit (for 340mm and 510mm high only)
- Set of linkers
- Available in Dove Grey and Silhouette Black frame finishes

Y320070	170mm Stage Height
Y320072	340mm Stage Height
Y320074	510mm Stage Height



Lite-Build Package B

- 4.5 x 2.25 metres
- 18 x Stage Tops
- 18 x Stage Frames
- 1 x Step Unit (for 340mm and 510mm high only)
- Set of linkers
- Available in Dove Grey and Silhouette Black frame finishes

Y320076	170mm Stage Height
Y320078	240mm Stage Height
Y320080	510mm Stage Height



Lite-Build Package C

- 5.25 x 3 metres
- 28 x Stage Tops
- 28 x Stage Frames
- 1 x Step Unit (for 340mm and 510mm high only)
- Set of linkers
- Available in Dove Grey and Silhouette Black frame finishes

Y320082	170mm Stage Height
Y320084	240mm Stage Height
Y320086	510mm Stage Height

Lite-Build Staging



Lite-Build Multi-Level Stage Packages

Lite-Build Package D

- 3 x 2.25 metres
- 12x Stage Tops
- 12x Stage Frame
- 4x Stacking Frames
- 1x Step Unit
- Set of linkers
- Available in Dove Grey and Silhouette Black frame finishes

Y320088 340mm Stage Height

Y320090 510mm Stage Height



10 Year
Warranty

Lite-Build Package E

- 4.5 x 2.25 metres
- 18x Stage Tops
- 18x Stage Frame
- 6x Stacking Frames
- 1x Step Unit
- Set of linkers
- Available in Dove Grey and Silhouette Black frame finishes

Y320092 340mm Stage Height

Y320094 510mm Stage Height



Lite-Build Package F

- 5.25 x 3 metres
- 28x Stage Tops
- 28x Stage Frame
- 7x Stacking Frames
- 1x Step Unit
- Set of linkers
- Available in Dove Grey and Silhouette Black frame finishes

Y320096 340mm Stage Height

Y320098 510mm Stage Height



Lite-Build Storage Truck

- Stack 24 Modules Per Trolley
- Needs to be ordered same time as stage

Y320100





Valance Colours

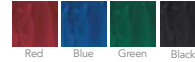

Deck Covering Colours



Alu Lite Staging



- Alu-lite is an extremely lightweight staging solution that is particularly suited to primary schools. Specially designed to take up minimal space and with a rigid bracing system, this is a stage that will withstand heavy loading yet is still so light that even the children could assemble it!
- Fast and efficient to assemble, the base opens in seconds to provide a surface rated at 1000kg even load distribution, yet folds to just 2% of the open size when closed!
- As well as the packages below, there are a wide range of sizes and formats available. Please speak to us to discuss your requirements
- A wide range of sizes and formats are available to ensure you have just the right stage, and our experienced personnel will visit to discuss your needs and provide a free demonstration
- Various Storage Trolleys can be selected to suit the doorway size for easy storage, and a whole range of extras from handrails to curtains are available for quick delivery

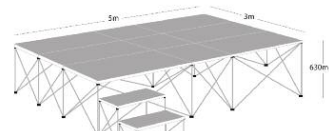
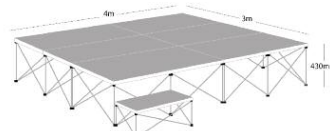
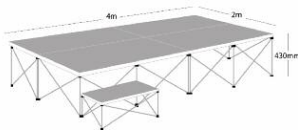

Please ask for site visit and demonstration

Alu Lite Package A

- 4x Stage Deck 2m x 1m
- 4x Stage Riser 2m x 1m – 400mm high
- 1x Stage Deck 1m x 0.52m
- 1x Stage Riser 1m x 0.52m – 200mm high
- 2x Riser Clamps

Y320020	Carpet Deck Covering
Y320025	Vinyl Deck Covering

Y320030	Valance for Package A
Y320035	Large Storage Trolley

Alu Lite Package B

- 6x Stage Deck 2m x 1m
- 6x Stage Riser 2m x 1m – 400mm high
- 1x Stage Deck 1m x 0.52m
- 1x Stage Riser 1m x 0.52m – 200mm high
- 2x Riser Clamps

Y320040	Carpet Deck Covering
Y320045	Vinyl Deck Covering

Y320050	Valance for Package B
Y320035	Large Storage Trolley

Alu Lite Package C

- 6x Stage Deck 2m x 1m
- 6x Stage Riser 2m x 1m – 600mm high
- 3x Stage Deck 1m x 1m
- 3x Stage Riser 1m x 1m – 600mm high
- 2x Stage Deck 1m x 0.52m
- 1x Stage Riser 1m x 0.52m – 200mm high
- 1x Stage Riser 1m x 0.52m – 400mm high
- 4x Riser Clamps

Y320055	Carpet Deck Covering
Y320060	Vinyl Deck Covering

Y320065	Valance for Package C
Y320035	Large Storage Trolley

Easi-Fold Staging

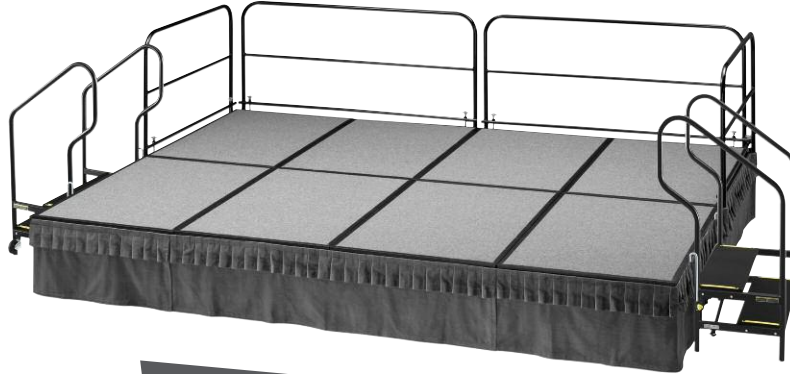

Please ask for site visit
and demonstration

- The quickest stage to set out and pack away
- A self-storing unit requiring single set up - a great labour saver
- Single or dual height units available in 3 different deck sizes
- Each unit rolls freely on its own four wheels - the added advantage of being able to be used in different rooms
- When in use, it rests on 8 direct-to-floor load bearing legs that stabilise the stage
- Stage accessories available including steps, hand rails, stage skirting, ramps etc
- Various package options available which include stage decks and steps - please ask for details
- Direct delivery and onsite training within 4 weeks
- Available as standard in black tuff deck vinyl or grey cord carpet. Other colours available on request

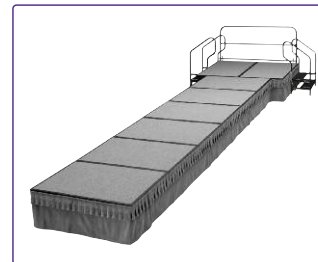



Rapid - our most popular range for schools

- The Rapid-Build staging range is a professionally designed and developed system that has been tried and tested – worldwide
- Stage platforms can be assembled and disassembled quickly
- The modular platforms allow the stage to be reconfigured into different layouts and heights using the detached leg options
- Adaptable to many applications
- Lightweight yet rigid and strong
- Compact for ease of storage
- Designed to eliminate clatter and stage squeak
- High quality design for long-term investment
- Special shape decks made to order
- Lifetime warranty
- Various surface finishes and edgings are available
- Virtually any shape, size, or height available

Best Seller



1 x 1 metre & 2 x 1 metre

- Ideal where ease of handling is the main priority or storage space is at a premium
- The quickest and most cost effective way to assemble and store a stage



Combi

- 2 x 1m standard size
- Multi-level deck with integrated scissor action legs
- Standard heights of 200, 400, 600, 800 & 1000mm

Rapid-Build Staging

Lifetime Warranty



Free design & demonstration service



Assembly stages



Stage Accessories

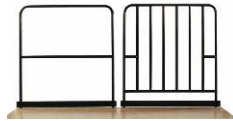

Handrails Standard and Infilled



Steps - Multi-height system steps with anti-slip surface



Transport Kit - You can store 40m² of staging in 2m² of floorspace

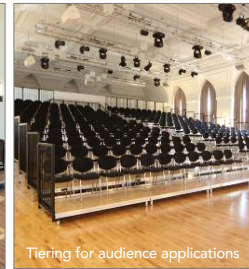

Tiering for audience applications

We strongly recommend a site visit before you order your stage to be certain your requirements are met in the most flexible and cost effective way.

Rapid-Build Staging

Lifetime Warranty



Free design & demonstration service

Staging & Auditorium Seating

Rapid-Build studio stage

The 'little' stage for your 'big' event.



LIFETIME
Warranty



Rapid-Build Studio Stage offers a complete package solution. It includes a 4 x 4m stage and lightweight, easy to assemble theatre curtain system. Ideal for school halls and drama departments. Sizes and colours can be individually tailored to suit every situation.

Please call for more information.

Assembly as simple as 1, 2, 3



Staging & Auditorium Seating



Auditorium Seating

A wide range of high quality seating systems offering solutions to suit every budget are available with an unrivalled Lifetime Warranty. Tried and tested to FIRA level 4 'severe category use', the systems are installed nationwide and further afield into universities, schools, courtrooms, theatres, town halls, sports centres and conference venues etc...

Product categories:-

- Auditorium Seating
- Lecture Theatre Seating
- Beam Seating
- Bench Seating
- Conference seating
- Demountable seating Systems
- Structural Steel & Timber Tiering Systems

Please call for
more
information

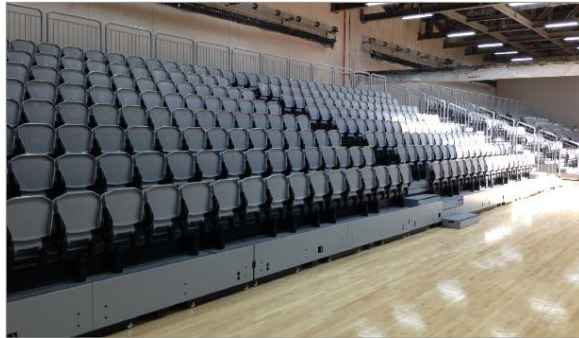



Are you and your visitors sitting comfortably?
Whether it's Office and Reception chairs, Sixth Form and Breakout seating or
Conference seating and IT chairs - they're all tried and tested, comfortable and robust.



SPACES TAYLORED

Seating

Soft Seating For Libraries, Staffrooms, Receptions, College, Breakout Coffee Tables & Laptop Tables	218-246
Operator Seating	247-248
Task Seating	249-254
Executive Seating	255-258
Ergonomic Back Care Seating	259-260
Conference & Cafe Seating Executive	261-262
Conference Seating Seating Size Guide	266-276
Fabric Swatches	277-280
	281-284

[Main Content Page](#)

Seating

When you buy seating, you are buying comfort.

We understand that work demands long hours of sitting and the chair sat on will make an impact not only on the quality of work delivered and students results, but also on users health.

All our seating ranges are selected for their excellent fit into learning environments, and our soft seating and reception ranges are designed to inspire and invigorate staff, visitors, and students alike.

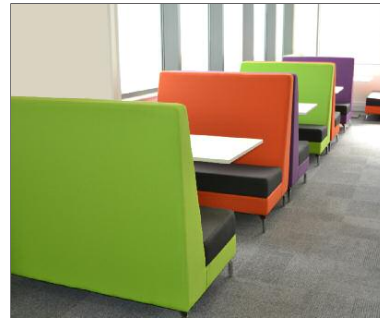

Seating



Seating



merlin plus 254



ellipse 255



chime mesh 256



florida 256



breathe 257



modern 257



cusiro 258



chess 258



westminster 259



strike 260



comfort 260



arrow exec. 261



gorgio 262



racer 262



milan 262



chelsea 263



amado 263



bordeaux 263



ergotek 264



posture 265



rheos 265



mercury 266



westbury 266



define 266



venus deluxe 267



galaxy 267



fleet plus 268



college fleet 268



mono 268



fleet 269



response 270



track 270



neptune 271



cathedral 272



vogue 272



kraft 273



stax 274



roma 274



fusion 275



oslo 276



narvik 276



molde 276



topaz 277



topaz mesh 277



topaz mobile 277



eames 278



milan cantilever
278



amado cantilever
278



chelsea cantilever
279



racer 279



bordeaux
cantilever 279

Quick search
product guide



Reception & Staffroom Seating

Aspect modular reception



- A flexible range of modular seating with wide range of arm choices
- Fully upholstered modular furniture with deep filled cushions for comfort
- Matching table with oak look or glass top



Note: Product shown in non standard fabrics. Please call for prices.



A. Chair - No Arms



B. Chair - Left Arm



C. Chair - Right Arm



D. Armchair



E. 2 Seater Sofa



F. Corner Unit



G. 30° Internal Link



H. 60° External Link



I. Oak Top Table

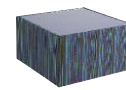

J. Glass Top Table

Reception & Staffroom Seating



Aspect Modular Reception

A. YREC25W*	Chair - No Arms
B. YREC26W*	Chair - Left Arm
C. YREC27W*	Chair - Right Arms
D. YREC28W*	Armchair
E. YREC29W*	2 Seater Sofa with Arms
F. YREC31W*	Corner Unit
G. YREC32W*	Internal Link
H. YREC33W*	External Link
YREC32LW*	Internal Link With Left Arm

YREC32RW*	Internal Link With Right Arm
YREC33LW*	External Link With Left Arm
YREC33RW*	External Link With Right Arm
I. YREC04W*	Oak Top Table
J. YREC04G*	Glass Top Table
YTWOT	Extra Charge for 2-Tone Fabrics from Band 1

* Please specify fabric colour

For seat dimensions see pages 277-280



Non standard fabric shown - please call for prices

For seat dimensions
see pages 277-280



Reception & Staffroom Seating

Horizon

- Comfortable angled seat



YHOR01	Horizon Modular Chair
YHOR01LA	Horizon Modular Chair w/Left Arm
YHOR01RA	Horizon Modular Chair w/Right Arm
YHORA	Horizon Modular Armchair
YHOR02	Horizon Modular 30 Degree Outer Corner Segment
YHOR03	Horizon Modular 30 Degree Inner Corner Segment
YHORCBE	Horizon Coffee Table, Beech Top
YHORCMA	Horizon Coffee Table, Maple Top
YHORCOA	Horizon Coffee Table, Oak Top
YHORCFB	Horizon Coffee Table, Fabric Top



Unlimited fabrics available

Prices shown are for Era, Phoenix, Rivet & X2 - see pages 281-284.
Please contact us for prices on other fabrics.



YHOR01



YHOR01LA



YHOR01RA



YHORA



YHOR02



YHOR03

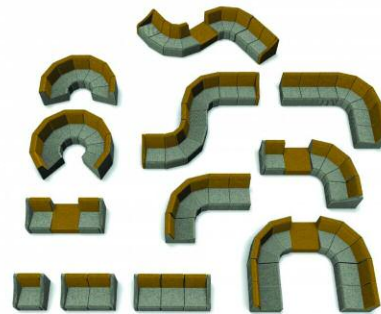

Reception & Staffroom Seating

Soft Seating Urban Bench

Urban Bench has connecting tables with low upholstered benches and matching coffee tables. The Urban Benches and connecting tables have been designed to allow clients flexibility to use space efficiently. Urban Bench and Table units are free-standing to ensure total flexibility. This modern design means that Urban Bench looks good as a single bench unit or in large configurations. Urban Bench and matching tables offer a stylish solution for any environment.

Code	Height	Width	Depth
URBAN 100	450mm	1200mm	450mm
URBAN 101	450mm	810mm	450mm
URBAN 102	450mm	450mm	450mm
URBAN 103	450mm	700mm	450mm
URBAN 104	250mm	450mm	450mm
URBAN 105	250mm	1160mm	450mm
URBAN 106	250mm	1160mm	810mm
URBAN 107	250mm	1160mm	1160mm

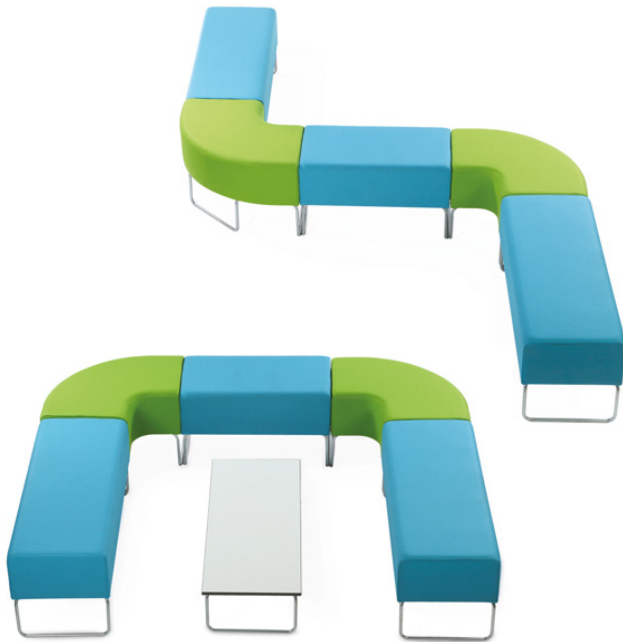

URBAN 100



URBAN 101



URBAN 102



URBAN 103

Reception & Staffroom Seating

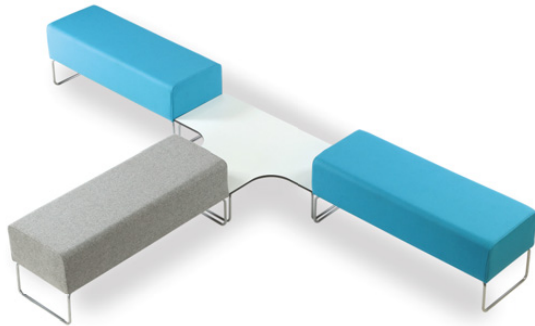
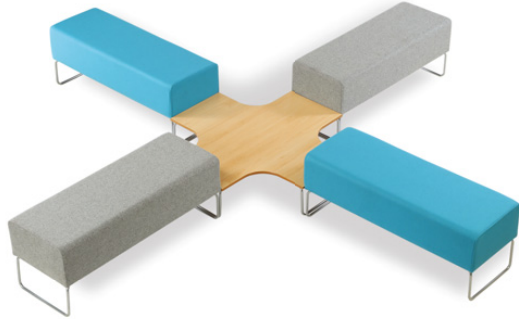

Laminated Table Top Colours

Maple	Oak
Beech	Light Grey
White	

Frame Colours

Light Grey	Chrome Silver
Black	White

Urban

- Beautifully simple
- Modular design means that Urban looks good as a single bench or as a large configuration to dramatically fill an atrium
- Chrome legs

Colour Options Unlimited fabrics available
Prices shown are for Era, Phoenix, Rivet & X2 - see pages 281-284. Please contact us for prices on other fabrics.

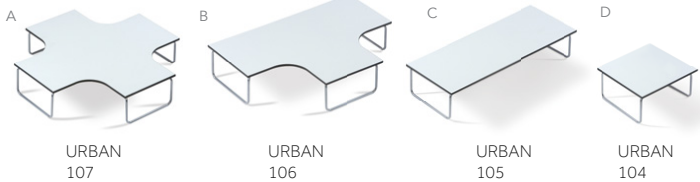

URBAN 107

URBAN 106

URBAN 105

URBAN 104



For seat dimensions
see pages 277-280

Jazz Chair

- Stylish design with waterfall seat
- Dark grey contemporary frame
- Available in Blue, Grey, Mustard or Red

YJAZZBL Jazz Chair Blue

YJAZZGR Jazz Chair Grey

YJAZZMU Jazz Chair Mustard

YJAZZRD Jazz Chair Red

Reception & Staffroom Seating

Jasmin

- Contemporary lounge chair with comfortable chunky seat
- In style frame
- Available in three fabric colours: - Mustard, Grey & Blue

YJASMU	Mustard
YJASBL	Blue
YJASGR	Grey



Jasper Chair

- A statement piece armchair
- Dark Grey contemporary frame
- Available in Blue, Grey or Mustard

YJASPERBL	Jasper Chair Blue
YJASPERGR	Jasper Chair Grey
YJASPERMU	Jasper Chair Mustard



For seat dimensions
see pages 277-280



Reception & Staffroom Seating

A. Upholstered Curved Stools



- Excellent for staffrooms, common rooms & heavy use areas
- Extra deep foam padding for extra comfort
- Black frame as standard, silver and grey available to order (price on request)

CS Upholstered Curved Stool

* Please specify fabric colour

15 Year
Maker's
Guarantee

Best
Seller



B. Imperial



- Extremely durable range of chairs
- Extra deep foam padding
- Black frame as standard, silver and grey available to order (price on request)

YIMP1* Side Chair

YIMPA* Armchair

* Please specify fabric colour



C. Cyprus



- Robust, rectangular steel frame
- Epoxy polyester frame coating
- Top grade, extra deep contour foam
- Highly polished, solid beech arms
- Complementary Beech laminate table tops
- Optional frame colours available (minimum order quantity of 10)

YCC50* Chair

YCC55* Armchair

YCC255* 2 Seater Armchair

YCC20 Square Coffee Table

YCC30 Rectangular Coffee Table

YCRAL7 Optional Grey Frame (min 10 items)

YCRAL9 Optional Silver Frame (min 10 items)

YCRAPF Cyprus Optional Platinum Frame

* Please specify fabric colour



Unlimited fabrics available

Prices shown are for Era, Phoenix, Rivet & X2 - see pages 281-284. Please contact us for prices on other fabrics.

For seat dimensions
see pages 277-280

Reception & Staffroom Seating

Meridian

- Low level beech framed seating
- 5 year guarantee
- No assembly required
- Flame retardant foam



YMER1A	Low Back Beech Chair
YMER1AA	Low Back Beech Armchair
YMER1RA	Low Back Beech Chair with Right Arm
YMER1LA	Low Back Beech Chair with Left Arm
YMER2AA	Low Back Beech Two Seater Settee with Arms
YMER1M	Medium Back Beech Chair
YMER1MA	Medium Back Beech Armchair
YMER1MRA	Medium Back Beech Chair with Right Arm
YMER1MLA	Medium Back Beech Chair with Left Arm
YMER2MA	Medium Back Beech Two Seater Settee with Arms
YMER1H	High Back Beech Chair
YMER1HA	High Back Beech Armchair
YMERSTA	Beech Square Table
YMERRTA	Beech Rectangular Table

* Please specify fabric colour

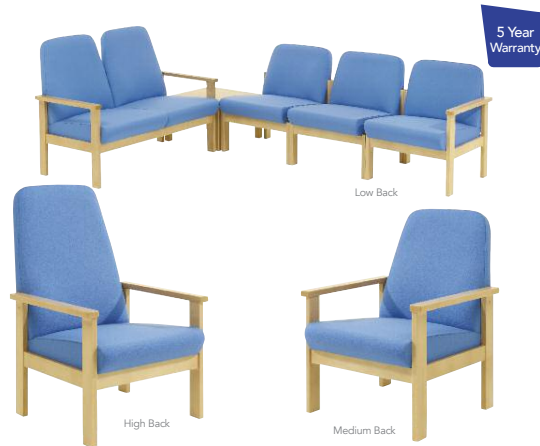

Unlimited fabrics available

Prices shown are for Era, Phoenix, Rivet & X2 - see pages 281-284. Please contact us for prices on other fabrics.

Blackwood

- Hardwood frames from sustainable sources
- Comfortable shaped back
- Mortice and tenon joints
- Flame retardant foam seats
- Modular design
- Manufactured in the UK
- 5 year guarantee



408	Blackwood Low Back
409	Blackwood Low Back with Arms
4114	Square Table
4115	Rectangular Table

* Please specify fabric colour



Unlimited fabrics available

Prices shown are for Era, Phoenix, Rivet & X2 - see pages 281-284. Please contact us for prices on other fabrics.

For seat dimensions see pages 277-280

5 Year
Warranty



Reception & Staffroom Seating

Classic tub chair & table



- Ideal for informal meeting points

RTC1	Tub Chair
RTC2	Tub Sofa

RTT2	Tub Wood Top Table
------	--------------------

YWOT	Extra Charge for 2-Tone Fabrics from Band 1
------	---

* Please specify fabric colour



Unlimited fabrics available

Prices shown are for Era, Phoenix, Rivet & X2 - see pages 281-284. Please contact us for prices on other fabrics.

Best
Seller



Retro leather tub

- Ideal for head teachers office or reception
- Sturdy and comfortable
- Faced in split leather in Black or Chocolate
- Other colours available to order

YREC10BK	Retro Tub Chair Black
----------	-----------------------

YREC10CH	Retro Tub Chair Chocolate
----------	---------------------------

YREC102BK	Retro Tub 2 Seater Black
-----------	--------------------------

YREC102CH	Retro Tub 2 Seater Chocolate
-----------	------------------------------

For seat dimensions
see pages 277-280

5 Year
Warranty



Retro fabric tub chairs



- Ideal for reception or Break Out Areas
- Available in Single or Double Seater
- Black Feet Glides
- 5 year warranty
- Made in the UK

Y600100	Single Tub
---------	------------

Y600102	Double Tub
---------	------------

Reception & Staffroom Seating

Legend

- Sturdily built chair
- Attractive beech wood or chrome feet
- Deep, fibre-topped seat cushions



Beech Feet

YLEG1B* Tub Chair

YLEG2B* 2 Seater

Chrome Feet

YLEG1C* Tub Chair

YLEG2C* 2 Seater

* Please specify fabric colour



Unlimited fabrics available

Prices shown are for Era, Phoenix, Rivet & X2 - see pages 281-284. Please contact us for prices on other fabrics.



Non standard fabric shown
- please call for prices

Pluto

- Compact stylish tub chair
- Modern chrome feet
- 2-tone fabric at no extra cost
- Ideal for areas with limited space
- Seat height 440mm, width 650mm overall
- Combining a generously proportioned seat with a compact overall footprint.
- Three foot styles: - Black Brushed, Polished Chrome & Polished Chrome Ball Foot. Comes as standard with Black Brushed. Please specify if non-standard option is preferred

YPSL1 Chair with Standard Foot Style

* Please specify fabric colour



Unlimited fabrics available

Prices shown are for Era, Phoenix, Rivet & X2 - see pages 281-284. Please contact us for prices on other fabrics.

For seat dimensions
see pages 277-280



Standard Foot Style



Special Foot Style



Reception & Staffroom Seating

Tide

- Modern visitor and reception chair
- Generously sized bucket seat



YTIG1*	Chair with 4 Legs
YTIG2*	Chair with Skid Base
YTIG3*	Chair with 4-Legged Return Swivel
YTIG4	Chair with Cross Over Skid Base
YTIG5	Coffee Table

* Please specify fabric colour

Colour Options Unlimited fabrics available
 Prices shown are for Era, Phoenix, Rivet & X2 - see pages 281-284.
 Please contact us for prices on other fabrics.



YTIG1



YTIG3



YTIG2



YTIG4

5 Year
Warranty

For seat dimensions
see pages 280-283

Consuelo

- Stylish visitor chair
- 4 base styles with platinum finish



A. YCON2	Visitor Seat with Spider Base
B. YCON3	Visitor Seat with 4 Leg Base
C. YCON4	Visitor Seat with Skid Base
D. YCONS	Visitor seat w/ black 4 legged frame

* Please specify fabric colour

Colour Options Unlimited fabrics available
 Prices shown are for Era, Phoenix, Rivet & X2 - see pages 281-284.
 Please contact us for prices on other fabrics.



B



A



D



C



Reception & Staffroom Seating

Sorano tub

- Choice of 3 stylish bases
- Trumpet & square base – height adjustable
- 360 degree swivel
- 5 year warranty

YSTRUMPET	Trumpet Base Height Adjustable
YSSQUARE	Square Base Height Adjustable
YSSPIDER	Spider Base

Colour Options Unlimited fabrics available
 Prices shown are for Era, Phoenix, Rivet & X2 - see pages 281-284.
 Please contact us for prices on other fabrics.

For seat dimensions
 see pages 277-280



Non standard fabric shown
 - please call for prices

Bucket chair

- Solid shell chair
- Comfortable, deep cushions
- Compact footprint

A. Y606300	Chair w/Platinum Cantilever Frame
B. Y606301	Chair w/Wooden Black Legs
Y606302	Chair w/Polished Beech Legs
C. Y606303	Chair w/Star Base, Height Adjustable

Colour Options Unlimited fabrics available
 Prices shown are for Era, Phoenix, Rivet & X2 - see pages 281-284.
 Please contact us for prices on other fabrics.



Helsingborg

- Comfortable designer look chair, adding style to any environment
- Available in chrome skid base, wooden frame or metal swivel base

A. Y607200	Chrome Skid Base Chair
B. Y607201	Wood Frame Chair
C. Y607202	Swivel Chair

Colour Options Unlimited fabrics available
 Prices shown are for Era, Phoenix, Rivet & X2 - see pages 281-284.
 Please contact us for prices on other fabrics.

Reception & Staffroom Seating

Landon

- Contemporary design
- Stylish detailing
- Deep foam for added comfort



10 Year Structural Warranty

YML011*	Landon Armchair
YML012*	Landon 2 Seater Sofa

* Please specify fabric colour



Unlimited fabrics available

Prices shown are for Era, Phoenix, Rivet & X2 - see pages 281-284. Please contact us for prices on other fabrics.

Platinum

- A classic design with exceptional build quality
- Enhances any environment whether it is commercial or domestic

YPLA001	Platinum Armchair
YPLA002	Platinum 2 Seater Sofa



Unlimited fabrics available

Prices shown are for Era, Phoenix, Rivet & X2 - see pages 281-284. Please contact us for prices on other fabrics.



Chesterfield sofa

- Made with Traditional Antique Leather
- UK Manufactured
- Available in single, double or triple seater
- Ask for Leather Swatch

YCHESERFIELDS	Single Seater	POA
YCHESERFIELDDD	Double Seater	POA
YCHESERFIELDT	Triple Seater	POA



Unlimited fabrics available

Prices shown are for Era, Phoenix, Rivet & X2 - see pages 281-284. Please contact us for prices on other fabrics.





Cushion pictured in non standard fabric - please call for prices



Reception & Staffroom Seating

Valencia



- Designed with striking square lines, deep fill cushions and a choice of legs
- Comes with chrome legs as standard, Beech and Walnut also available, please ask
- UK made

YVAL01	Valencia Armchair	£706.00
YVAL02	Valencia 2 Seat Sofa	
YVAL03	Valencia 3 Seat Sofa	
YVALC	Square Cushion, 400 x 400mm	

Colour Options Unlimited fabrics available
 Prices shown are for Era, Phoenix, Rivet & X2 - see pages 281-284. Please contact us for prices on other fabrics.

10 Year Warranty



For seat dimensions see pages 277-280

Azure



- Contemporary sofa range
- Chrome feet as standard, wood available
- Please call for prices for this range in leather as shown
- Seat width 930mm, depth 920mm

YAZU001*	1 Seater
YAZU002*	2 Seater
YAZU003*	3 Seater

* Please specify fabric colour

Colour Options Unlimited fabrics available
 Prices shown are for Era, Phoenix, Rivet & X2 - see pages 281-284. Please contact us for prices on other fabrics.

Seating

Reception & Staffroom Seating

Infinity

- Black bonded leather sofa range
- Modern aesthetic design
- Ideal for reception areas and common rooms

Bonded Leather

IYMOD3	Cube Chair
IYMOD2	Corner Unit
IYMOD1	Straight Back Sofa



5 Year
Warranty



For seat dimensions
see pages 277-280

Reception & Staffroom Seating



Please note that back extensions cannot be retrospectively fitted

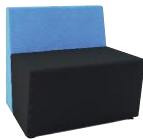

Single seater straight unit

Y600110 Single Seater
Y600115 Single Seater Back Extension



2 seater straight unit

Y600120 2 Seater
Y600125 2 Seater Back Extension



3 seater straight unit

Y600130 3 Seater
Y600135 3 Seater Back Extension



Corner unit

Y600140 Corner Unit
Y600145 Corner Unit Back Extension

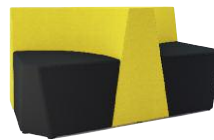

T module unit

Y600150 T Module Unit
Y600155 T Module Unit Back Extension

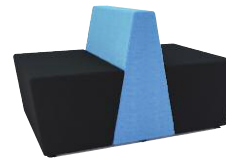

Back to back single seater

Y600160 Back to Back Single Seater
Y600165 Back Extension

Reception & Staffroom Seating



Shown with back extension

Oasis

- Comfortable modular seating
- Optional back 530mm extension
- Endless configurations

Please note that back extensions cannot be retrospectively fitted



Unlimited fabrics available

Prices shown are for Era, Phoenix, Rivet & X2 - see pages 281-284. Please contact us for prices on other fabrics.



Back to back double seater

Y600170 Back to Back Double Seater
Y600175 Back Extension

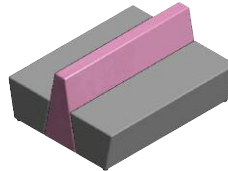

Back to back triple seater

Y600180 Back to Back Triple Seater
Y600185 Back Extension



45 degree concave

Y600190 45 Degree Concave Unit
Y600195 Back Extension

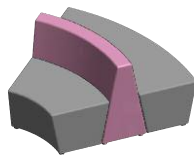

45 degree back to back curved unit

Y600200 Back to Back Curved Unit
Y600205 Back Extension



D end unit

Y600210 D End Unit

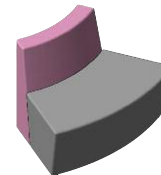

45 Degree convex unit

Y600220 45 Degree Convex Unit
Y600225 Back Extension



Reception & Staffroom Seating

Raft

- Highly versatile modular seating system
- Many configurations can be created
- Solid Beech wood frames
- Sprung seat
- Bespoke skidbase frame available – please enquire

A.	YRAF1	Single Base Unit
B.	YRAF1B	Single Base Unit w/Back
C.	YRAF1BR	Single Unit w/Back & Right Arm
D.	YRAF1BL	Single Unit w/Back & Left Arm
E.	YRAF1BA	Single Unit w/Back & Two Arms
F.	YRAF1CB	Single Unit w/Corner Back
G.	YRAF2	Double Base Unit
H.	YRAF2B	Double Unit w/Back
I.	YRAF2BR	Double Unit w/Back & Right Arm
J.	YRAF2BL	Double Unit w/Back & Left Arm
K.	YRAF2BA	Double Unit w/Back & Two Arms
L.	YRAF3	Quadrant Base Unit
M.	YRAF4	Table with Beech Top
N.	YRAF3B	Triple Unit w/Back
O.	YRAF3BA	Triple Unit w/Back & 2 Arms

Colour Options Unlimited fabrics available
 Prices shown are for Era, Phoenix, Rivet & X2 - see pages 281-284.
 Please contact us for prices on other fabrics.

For seat dimensions
 see pages 277-280

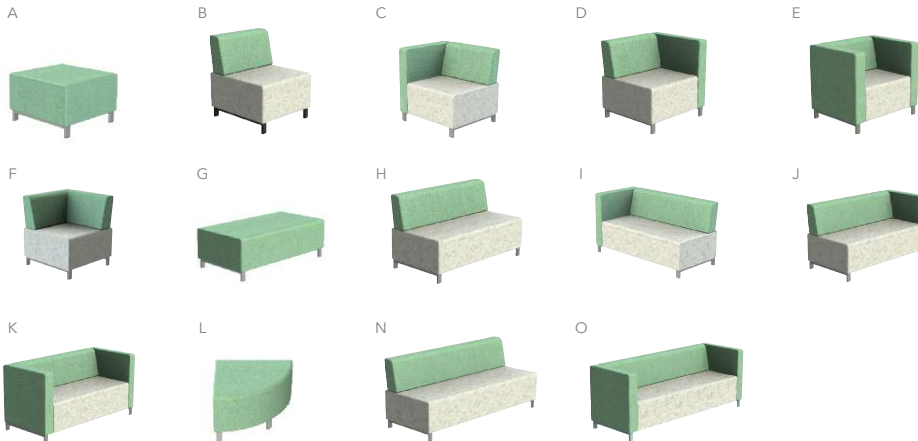

Reception & Staffroom Seating

Raft high back

- Highly versatile modular seating system
- Many configurations can be created
- Solid Beech wood frames
- Sprung seat

A. YRAFH1	Single Unit, High Back
B. YRAFH1R	Single Unit, High Back & Right Side
C. YRAFH1L	Single Unit, High Back & Left Side
D. YRAFH1S	Single Unit, High Back & Sides
E. YRAFH2	Double Unit, High Back
F. YRAFH2R	Double Unit, High Back & Right Side
G. YRAFH2L	Double Unit, High Back & Left Side
H. YRAFH2S	Double Unit, High Back & Sides
I. YRAFHCV	Concave Unit, High Back
J. YRAFHCV	Convex Unit, High Back
K. YRAFHC	High Back Unit, Corner Back
L. YRAFHV	Vertical Unit (includes Links)
M. YRAFHVT	Vertical Unit, Single Width Table
N. YRAFHDT	Vertical Unit, Double Width Table

Options

O. YRAFCL	Option - Chrome Legs
P. YRAFBL	Option - Beech Legs
Q. YRAFLNK	Option - Linking kit (one side)
R. YRAFPM1	Option - Power Module 1, Power & Twin USB Fast Charge
S. YRAFPM2	Option - Power Module 2, HDMI & Single USB Fast Charge

Colour Options Unlimited fabrics available
 Prices shown are for Era, Phoenix, Rivet & X2 - see pages 281-284.
 Please contact us for prices on other fabrics.



For seat dimensions see pages 277-280



Non standard fabric shown - please call for prices



Reception & Staffroom Seating

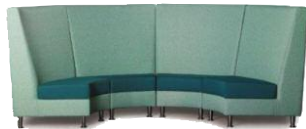

Whisper



- A. YWHIS1 Whisper Straight High Back Seat Unit
- B. YWHIS2 Whisper 45 Degree Concave High Back Seat Unit
- C. YWHIS3 Whisper 45 Degree Convex High Back Seat Unit



Unlimited fabrics available

Prices shown are for Era, Phoenix, Rivet & X2 - see pages 281-284. Please contact us for prices on other fabrics.

Reception & Staffroom Seating

City sofas

- Versatile modular seating system
- Deep seat foam
- Heavy duty steel under frame
- Welded steel linking option meaning that units can be fixed together



A.	YCITB1	City Single Seat With Back
B.	YCITDB1	City Double Seat With Back
C.	YCITTB1	City Three Seat With Back
D.	YCIT1	City Single Seat Without Back
E.	YCIT2	City Double Seat Without Back
F.	YCIT3	City Three Seat Without Back
G.	YCIT4	90 Deg External Corner Seat w/ Back
H.	YCITC1	90 Deg Internal Corner Seat w/ Back
I.	YCITCON1	City Corner Seat Without Back
J.	YCITTAB2	City 4 Way Seat

Table

- Beech Laminate Table Top

K.	YCITCTB	City Table With Beech Top
----	---------	---------------------------

Optional Extras

- Arms available upholstered or in Beech or Walnut laminate

L.	YCITA1	Extra Cost for Arm, Upholstered
M.	YCITA2B	Extra Cost For Arm, Beech
	YCITLKL	Extra Cost For Link -Left Hand as Seated
	YCITLKR	Extra Cost for link - Right Hand as Seated

Colour Options Unlimited fabrics available
 Prices shown are for Era, Phoenix, Rivet & X2 - see pages 281-284.
 Please contact us for prices on other fabrics.



New Product



Reception & Staffroom Seating

Sydney

- Low & high back options
- Moulded plywood Shell
- Variety of base options
- Fully upholstered – two tone fabric option available
- Veneer outer shell available as an upgrade

Low Back

Y602000	With Skid Base
Y602010	With 4 Star Base
Y602020	With Round Flat Base
Y602030	With Wooden 4 leg

High Back

Y602040	With Skid Base
Y602050	With 4 star Base
Y602060	With Round flat Base
Y602070	With Wooden 4 leg

Upgrade options

YSLBWB	Walnut Veneer Outer on Low Back
YSHBWB	Walnut Veneer Outer on High Back
YSLBWL	Lacquered White Outer on Low Back
YSHBWL	Lacquered White Outer on High Back



Unlimited fabrics available

Prices shown are for Era, Phoenix, Rivet & X2 - see pages 281-284. Please contact us for prices on other fabrics.



Reception & Staffroom Seating

Stockholm

- High or low back winged back classic armchair
- Available with Swivel base, Solid Oak or Skid Frame
- Foot rest available

High Back

Y609100	High with Swivel Base	POA
Y609101	High Back with Solid Oak Frame	POA
Y609102	High with Skid Base	POA

Low Back

Y609103	Low Back Swivel Base	POA
Y609104	Low Back Solid Oak Frame	POA
Y609105	Low Back Skid Base	POA



Non Standard fabrics – please call for prices





Breakout Seating

Nook

- Improve space utilization through flexibility.
- Activate challenging areas such as corridors and under stairs.
- Provide one to one consultation and guidance spaces.
- Cater for neurodiverse students and staff.
- Moveable support space brings resource where its needed
- Recharge and semi-private breathing space for staff

OPTIONAL SENSORY ADDITIONS

- Vibrating seat pad. Helps with ADHD & general muscle relaxation for improved focus
- Safety Mirror on rear wall. Helps autistics make eye contact to build better rapport.
- LED Light Panels. Bathe the space in colour to influence mood
- and the brains ability to process information. Autism & Dyslexia.

YP630000 Nook Booth

POA

New Product



● HUDDLE POD

MEET AND WORK IN SAFETY. SELF-REGULATE AND ENGAGE AWAY FROM THE CROWD

● OPEN SHELTER

USABLE BY EVERYONE AT ALL TIMES. BRING YOUR COMPLETE SELF TO WORK. ADA COMPLIANT

● SOLO BOOTH

A PERSONAL SPACE FOR VIDEO CONFERRING, CALLS AND DEEP WORK



● COVID Elements

PARTITION SCREENS, ANTIMICROBIAL SURFACES, AIR-CLEANSING, ALL FUTUREPROOF

● Highly Adaptable

UTILISE EXISTING FURNITURE. MAXIMUM FLEXIBILITY AND INCLUSIVITY

● Open Sided

BALANCING SHELTER WITH OPENNESS, AVOIDING ISOLATION.



UK Manufactured

Breakout Seating



37% average recycled content.



91% average recyclable content.



Sound absorption

Zen panels are tested and rated at 30dB noise reduction. The panels achieve this with an internal layer of sound absorbing foam. SRL technical report, ref. no. 22913 T01.

Zen

Zen Curved High Back Sofa Booth is part of our sound absorbing range by creating a quiet space to work. Zen is remarkably flexible leaving no limitation, only your imagination. We can manufacture to almost any shape or size. Whether you want a breakout area for employees, a calming place of concentration or simply an area to communicate. Also available with integrated media and power facilities, Zen has a solution.

ZO3B Zen 2 Seater

ZO4B Zen 4 Seater



Unlimited fabric options available, please enquire



UK Manufactured

Reception & Staffroom Seating



Aston Hut

- For a greater degree of privacy, the Aston Hut provides the answer. The Aston Hut features a high acoustic surround, with the addition of a complete upholstered roof create a fully upholstered seating solution for four or six persons
- Wherever you situate the Aston Hut, it will exude understated, restful confidence and create a genuine talking point

Options available: -

- Single or two tone fabrics
- Upholstered arm cushions
- Upholstered Rectangular loose cushions
- Upholstered Square loose cushions
- MFC Vase shaped table
- Power module – 2 x power
- Power module – 2 x power, 2 x USB
- Power module – 1 x power, 2 x USB, 1 x HDMI

Y609800	Aston 4 Seater Hut	POA
Y609801	Aston 6 Seater Hut	POA

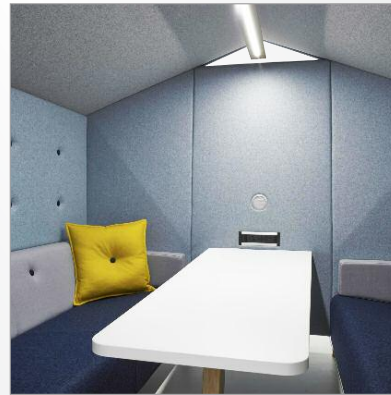



Unlimited fabric options available, please enquire

Confer

- Confer is a range that is needed in most open space environments in today's interior space planning.
- Whether you are making a phonecall, having a one 2 one meeting, group meetings, private chats or just sitting in an area that is comfortable and pleasing to the eye the confer range provides it all, while reducing the noise level
- Includes standard MFC panels & desktop on pedestal base
- Power, lighting and TXV rackets also available – please enquire

Flat Roof

Y620100	1 Seater Booth	POA
Y620105	2 Seater Booth	POA
Y620110	4 Seater Booth	POA

Pitched Roof

Y620115	2 Seater	POA
Y620120	4 Seater	POA

Stylo & Stylo Plus



- Singularly or in groups, this versatile range of soft seating with endless configurations, makes for an interesting seating solution, whether for reception or breakout areas
- Adult and junior sizes
- Stylish, multi functional design
- No assembly required
- Flame retardant foam

Stylo

YLU21	Circular Seat
YLU22	Dogbone Seat
YLU23	Kidney Shaped Seat
YLU24	Square Seat
YLU25	Apostrophe Seat
YLU26	Double Seater
YLU28	Quadrant



5 Year Warranty

Stylo plus

Like the Stylo but with chrome feet and adult sizes

- Eight stylish designs

YLP21	Circular Seat
YLP22	Dogbone Seat
YLP23	Kidney Shaped Seat
YLP24	Square Seat
YLP25	Apostrophe Seat
YLP26	Double Seater
YLP27	Circular Nibble



For seat dimensions see pages 277-280



Unlimited fabrics available

Prices shown are for Era, Phoenix, Rivet & X2 - see pages 281-284. Please contact us for prices on other fabrics.

Causeway

- These irregular hexagonal form seats are available in two heights that serve as both sitting and backrest units
- Can be freely combined in infinite arrangements
- Ideal for chillout zones, waiting areas and entrance halls
- Connected with black, powder coated metal links

YCWAYHU	High Unit (750mm)
YCWAYLU	Low Unit (450mm)





Coffee Tables

Adjustable Laptop table

- Soft touch tactile height adjustment lever with manual height adjustment 625mm – 1050mm
- Weight capacity - 5 kg
- Fully customisable - any top fits any base

Top Only

CMS2659	White
CMS2660	Black
CMS2661	Beech

Base Only

CMS2577	Silver
CMS2558	White
CMS2559	Black
CMS2560	Extra Charge for Chrome



Colour top coffee tables

- A range of wooden coffee/childrens' tables
- The core material is birch ply with an exposed polished edge, and solid timber legs
- Tops are finished in laminate
- Size: H450 x W600 x D600mm

YCRT600	Round
YCST600	Square



Non standard fabric shown - please call for prices

Aspect coffee table

- Matches the aspect range of modular seating on page 213
- Table with oak look top

YREC04W*

For seat dimensions see pages 277-280

Coffee Tables

Chrome column leg coffee tables

- Premium laminate top in a choice of colours - please specify when ordering
- Height 505mm
- 2mm ABS edge

A. YTRUCC	Circular 600mm Diameter
B. Y600390	Square 600 x 600mm
C. Y600400	Rectangular 1000 x 600mm

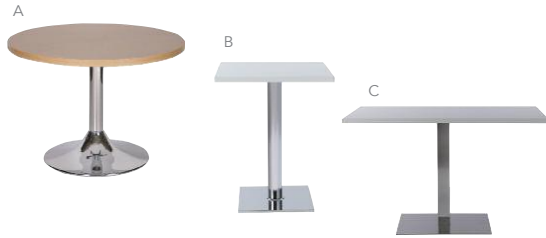
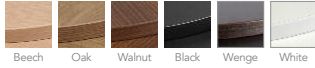

Page Link - see pages
For dining furniture 164-178



Alpine coffee tables

- Matches with office furniture on pages 296 to 297

Panel Base, MFC Tables H400mm

D. YZZN603	Square Table, H600 x D600
E. YZZN100	Rectangular Table, W1000 x D600
F. YZZN651	Round Coffee Table, Ø650



Gothenburg coffee tables

- White laminate top

Y608108	Square Coffee Table
Y608109	Rectangular Coffee Table



Express Delivery



Operator Seating

E-Magic

- Twin lever mechanism
- Back height and angle adjustment
- Styles may vary
- Supplied flat pack for self assembly
- Fixed arms available at additional cost



YEMAG01B	Operator Chair
YEMAGA	Fixed Arms

Fabric Options

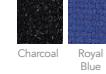

For seat dimensions see pages 277-280



Large back with pump up lumbar support

Best Seller

5 Year Warranty

Breeze

- Luxury operator chair
- Advanced lumbar support - for extra back support
- Large back chair has pump up lumbar support
- 3 lever mechanism allows extra adjustment
- Heavy duty gas lift allows heavier use
- Deep padded foam seat for added comfort
- Larger back



A. YBRELB*	Large Back Pump up Lumbar
B. YBRELBA*	Large Back with Fixed Arms
C. YBRELAJ*	Large Back with Adjustable Arms
YTWOT	Extra Charge for 2-Tone Fabrics from Band 1

*Please specify fabric colour



Unlimited fabrics available

Prices shown are for Era, Phoenix, Rivet & Advantage – see pages 281-284. Please contact us for prices on other fabrics



Operator Seating

Merlin

- Low price, high quality
- High back and medium back
- 5 year guarantee



A. Y20106*	Mid Back
B. Y20111*	Mid Back - Fixed Arms
C. Y20113*	Mid Back - Adjustable Arms
D. Y20108*	High Back
Y20110*	High Back - Fixed Arms
Y20112*	High Back - Adjustable Arms
G. Y20301*	High Back Draughtsman Chair
H. Y20201*	H/Back Cantilever Conference Chair
I. YCH	Chrome Base
J. YCFA	Chrome Fixed Arm
K. YFOLD	Folding Arms
YPULS	Pump up Lumbar Support
YTLM	Three Lever Mechanism (seat tilt)
YTWOT	Extra Charge for 2-Tone Fabrics from Band 1

* Please specify colour fabric

Colour Options Unlimited fabrics available
 Prices shown are for Era, Phoenix, Rivet & Advantage – see pages 281-284. Please contact us for prices on other fabrics



Non standard fabric shown - please call for prices



High Back



Mid Back



Some chair options are not shown in the price list - please call for details

For seat dimensions see pages 277-280

5 Year
Warranty



Operator Seating

Score

- Ergonomic operator chair
- Sculptured seat and back for greater comfort
- 2 lever mechanism
- Hand wheel back height adjustment



YGLSHB	High Back Operator Chair
YGLSHMA	High Back Operator Chair with Fixed Arms
YGLSHAT	High Back Operator Chair with Adjustable Arms

* Please specify colour fabric

Colour Options Unlimited fabrics available
Prices shown are for Era, Phoenix, Rivet & Advantage – see pages 281-284. Please contact us for prices on other fabrics

For seat dimensions see pages 277-280

5 Year
Warranty



Merlin plus

- Modern, comfortable square back
- Twin lever mechanism
- Adjustable back height



A. YMPS66	Merlin Plus High Back
B. YMPS66FA	Merlin Plus - Fixed Arms
C. YMPS66ADJ	Merlin Plus - Adjustable Arms
YTWOT	Extra Charge for 2-Tone Fabrics from Band 1

Colour Options Unlimited fabrics available
Prices shown are for Era, Phoenix, Rivet & Advantage – see pages 281-284. Please contact us for prices on other fabrics

Other options - please call for details





Operator Seating

Ellipse

- Superior operator chair range for the discerning buyer
- Optional aluminium base
- Matching visitor chairs
- Visitor chairs have 25mm steel cantilever frame

A. YE50622*	Ellipse Operator Chair
B. YE50622FA*	Ellipse With Fixed Arms



Unlimited fabrics available
 Prices shown are for Era, Phoenix, Rivet & Advantage – see pages 281-284. Please contact us for prices on other fabrics

* Please specify colour fabric



Page Link - see pages
 For fabric swatches
 281-284



For seat dimensions
 see pages 277-280



Operator Seating

Chime mesh



A. YCHI1B	Operator Chair
B. YCHI1BFX	Operator Chair, Fixed Arms
C. YCHI1BAD	Operator Chair, Adjustable Arms
D. YCHI1BFA	Operator Chair, Folding Arms
E. YCHI1C	Operator Chair, Chrome Base
F. YCHI1CAD	Operator Chair, Chrome Base, Adjustable Arms
G. YCHI1CFA	Operator Chair, Chrome Base, Folding Arms
H. YCHI2B	Draughtsman Chair
I. YCHI2BAD	Draughtsman Chair, Adjustable Arms
J. YCHI2BFA	Draughtsman Chair, Folding Arms

* Please specify fabric colour

Colour Options Unlimited fabrics available
 Prices shown are for Era, Phoenix, Rivet & Advantage – see pages 281-284. Please contact us for prices on other fabrics

For seat dimensions see pages 277-280

High chair with footrail for use at high worksurfaces



New Product

Florida Mesh Chair

- Ratchet back
- Three lever mechanism – Dual control
- Mechanism weight tension control
- Seat slide
- Flame retardant foams
- Class 4 gas stem up to 25 stone/150 kilos
- 5 year guarantee (8 hour use)

Y600300	Florida Chair
Y600301	Florida Chair w/fixed arms
Y600302	Florida Chair w/adjustable arms
Y600303	Florida Chair w/folding adjustable arm

Colour Options Unlimited fabrics available
 Prices shown are for Era, Phoenix, Rivet & Advantage – see pages 281-284. Please contact us for prices on other fabrics

Operator Seating

Breathe Chair

Made to suit even the pickiest sitter, this is a task chair that has been designed with long-term comfort in mind. The precisely tensioned back mesh will keep you cool and dry all day long, while the inbuilt lumbar support and Operator Synchro mechanism will ensure each member of your team can set up their chair precisely to suit them. It's a one-size-fits-all office chair that follows best practice for long-term healthy sitting.

- Cool, flexible mesh back
- Push button mechanism control
- Body Balance mechanism for 'dynamic sitting'
- Height adjustable lumbar pad

YBV32	Chair w/height adjustable lumbar pad
YBV32ADJ	Chair w/Adjustable Arms
YBVC30	Meeting Chair w/adjustable Lumbar pad
YBVEX30	Meeting Chair w/Lumbar pad & Arms
YBV40	4 legged Meeting Chair
YBV40A	4 Legged Meeting Chair w/Arms
YBV50	Cantilever Chair
YBV50A	Cantilever Chair w/Arms

Colour Options Unlimited fabrics available
 Prices shown are for Era, Phoenix, Rivet & Advantage – see pages 281-284. Please contact us for prices on other fabrics



The modern chair

- Aerated Polypropylene back
- Integrated Seat Slide
- Synchro Mechanism
- White or Black base & back Options

Y600420	White Operator Chair
Y600440	Black Operator Chair
Y600430	White Chair with Adjustable Arms
Y600450	Black Chair with Adjustable Arms

Colour Options Unlimited fabrics available
 Prices shown are for Era, Phoenix, Rivet & Advantage – see pages 281-284. Please contact us for prices on other fabrics



Y600450

Y600420

Y600430



New Product



Y600440

For seat dimensions see pages 277-280

Best Seller **5 Year Warranty** **Express Delivery**



Non standard fabric shown - please call for prices



Non standard fabric shown - please call for prices

Task Seating

Cusiro task chair

- Ergonomic, permanent contact back with weight control



A. YTRA11	Black Components
B. YTRA11FA	Black Components & Fixed Arms
C. YTRA11A	Black Components & Adj Arms
D. YTRA12	Chrome Components
E. YTRA12FA	Chrome Components & Fixed Arms
F. YTRA12A	Chrome & Adjustable Arms
YTWOT	Extra Charge for 2-Tone Fabrics from Band 1

* Please specify fabric colour

Colour Options Unlimited fabrics available
Prices shown are for Era, Phoenix, Rivet & Advantage – see pages 281-284. Please contact us for prices on other fabrics

For seat dimensions see pages 277280

Chess



A. YCHE01	Task Chair with No Arms
B. YCHE01F	Task Chair with Fixed Arms
C. YCHE01AA	Task Chair with Adjustable Arms
D. YCHE01D	Task Chair with Folding Arms
E. YCHE02	Task Chair with Chrome Base and No Arms
F. YCHE02F	Task Chair with Chrome Base and Fixed Arms
G. YCHE01A	Task Chair with Chrome Base and Adjustable Arms
H. YCHC01D	Task Chair with Chrome Base and Folding Arms
YTWOT	Extra Charge for 2-Tone Fabrics from Band 1

* Please specify fabric colour

Colour Options Unlimited fabrics available
Prices shown are for Era, Phoenix, Rivet & Advantage – see pages 281-284. Please contact us for prices on other fabrics

Task Seating



- Pump up lumbar support to a comfortable inflation and release with push button
- Lift levers to release back synchronised mechanism. Back and seat are now in free float. Push levers down to lock in position.
- Lift and hold lever to operate gas height adjustment. Set to desired height and release. (Front Lever)



- Lift back 7 increments to desired height, 8th position returns back to lowest setting
- Lift arm by lifting lever under the arm and adjusting to suit
- Lift lever to adjust sliding seat, release to lock in position (left lever)
- Turn to adjust tension depending upon operator's weight

For seat dimensions see pages 277-280

Westminster task chair

- Brilliant value for money task chair
- Highly ergonomic
- Contoured seat and back
- Heavy duty back
- Synchronised or independent mechanism - synchronised moves seat and back together, independent mechanism adjusts them separately



Unlimited fabrics available

Prices shown are for Era, Phoenix, Rivet & Advantage – see pages 281-284. Please contact us for prices on other fabrics

A. YHYP1	Chair, Black Components
B. YHYP1F	Chair, Black Components w/Fixed Arms
C. YHYP1A	Chair, Black Components w/Adj Arms
D. YHYP1V	Visitor/Conference Chair
E. YHYP1VA	Visitor/Conference Chair w/Arms
F. YHYP1VFA	Visitor/Conference Chair w/Frame Arms
G. YHYP2	Task Chair With Chrome Components
H. YHYP2F	Task Chair w/Chrome Components & Fixed Arms
I. YHYP2A	Task Chair Chrome w/Adjustable Arms
J. YHYP2V	Visitor/Conference Chair in Chrome
K. YHYP2VA	Visitor/Conference Chair in Chrome w/Arms
L. YHYP2VFA	Visitor/Conference Chair in Chrome w/Frame Arms

*Please specify fabric colour Please choose synchronised or independent mechanism



5 Year
Warranty



Task Seating

Strike



- Black polypropylene with glass fibre frame
- Black upholstered seat
- Black string mesh backrest
- 2D Arms - Height Adj & Distance
- Synchro mechanism
- Lumbar height adjustment

YTRA17A* Task Chair with Adjustable Arms



Unlimited fabrics available

Prices shown are for black fabric only. Please contact us for prices on other fabrics

For seat dimensions
see pages 277-280



Comfort Chair

- The Ergonomically designed Task chair with large seat & back
- Three lever mechanism - Dual Control, Mechanism weight tension control, Thunder base
- Rubber Castors
- Pump up lumbar
- Ratchet back
- Seat slide
- Black or Chrome components
- Flame retardant foams
- Class 4 gas stem up to 25 stone/150 kilos

YCOML	Chair Black Base
YCOMLAA	Chair Black Base & Adj. Arms
YCOMLFA	Chair Black Base & Folding Arms
YCOMLC	Chair Chrome Base
YCOMLAAC	Chair Black Chrome & Adj. Arms
YCOMLFAC	Chair Black Chrome & Folding Arms



Unlimited fabrics available

Prices shown are for Era, Phoenix, Rivet & Advantage – see pages 281-284. Please contact us for prices on other fabrics

Task Seating

Arrow executive chair

- High back executive style chair at incredible value
- Superb Back support
- Pump up Lumbar support
- Adjustable seat and back angle
- Height adjustable arms and headrest available
- Available with chrome base & arms POA
- 5 year guarantee

A. YAIF2	Visitor/Conference Chair, Black Frame
B. YAIF2A	Visitor/Conference Chair w/Arms, Black Frame
C. YAIF3	Visitor/Conference Chair with Chrome Frame
D. YAIF3A	Visitor/Conference Chair with Chrome Frame and Arms
E. YAIF81	Executive Chair - No Arms
F. YAIF81ADJ	Executive Chair With Adjustable Arms
G. YAIF91ADJHR	Executive Chair With Adjustable Arms & Headrest

Options

YAIFAP	Polished Aluminium Base (Task Chairs Only)
YAIFCF	Additional Cost for Chrome Cantilever Frame
YAIFCFA	Additional Cost for Chrome (Conference Chair with Arms)
YAIFMF	Arrow Optional Memory Foam Seat
YAIFSS	Arrow Optional Seat Slider

Genuine Leather Options

YAIF2AL	Leather Conference Chair with Arms
YAIF2L	Leather Conference Chair
YAIF81ADJL	Leather Executive Chair With Adjustable Arms
YAIF81L	Genuine Leather Executive Chair
YAIF91ADJHRL	Leather Executive Chair, Adjustable Arms & Headrest



5 Year
Warranty



Unlimited fabrics available
Prices shown are for Era, Phoenix, Rivet & Advantage – see pages
281-284. Please contact us for prices on other fabrics

Page Link - see pages
For
fabric
swatches

281-284



For seat dimensions
see pages 277-280



Manager & Executive Seating

Gorgio

- Sleek high back executive chair
- Black castors for carpets, Ø 60 mm
- Four position synchronized mechanism
- Fully upholstered shell
- Rocking mechanism with a lateral backrest tension adjustment
- 4 locking positions

Y610500



Page Link - see page
Executive
conference
seating → 278-279



Racer

- A stylish high back executive chair featuring a five locking position synchronized mechanism aluminium base, aluminium arms and PU arm pads

YRAC01 Black Managers Chair

5 Year
Warranty



For seat dimensions
see pages 277-280

Milan

- Dynamic seat and backrest
- Seat and backrest tilt lockable in upright position
- Adjustable seat height
- Wide comfortable seat and backrest
- Natural split leather faced
- Polished chrome base
- Black only

YNEO1BK

Manager & Executive Seating

Chelsea

- A superb high back executive chair
- Five locking position synchronized mechanism
- Aluminium base and arms
- PU arm pads
- Matching cantilever available(see page 279)

YCHEL01



Amado

- H/A lumbar support
- Tilt mechanism, 5 locking positions
- Height adjustable upholstered seat & back
- Fabric to front & mesh to back of backrest
- H/A Arms

YAMD1



Bordeaux director's chair

- Unique floating lumbar support
- Synchro mechanism with tension adjustment & anti-kick safety feature
- Features adjustable back, lockable at 3 heights.
- Seat side
- 4D multifunctional arms to adjustment length, width and height.
- Multi-adjustable head rest
- Polished aluminum base
- Fully finished in black mesh.

Y600230



For seat dimensions
see pages 277-280



For seat dimensions see pages 280-283



Ergonomic Backcare Seating

Ergotek task chair

- Physiotherapist approved ergonomic back care chair
- Ratchet back height adjustment
- Deep moulded foam for superior user comfort
- Compliant with HSE seating at work directives
- SATRA tested to BS 5459 level S severe use
- Weight capacity 150kg, cantilever 110 kg
- Seat Slide

Ergotek

A. YERGM	Mid Back Task Chair
B. YERGH	High Back Task Chair

Ergotek+ Larger, fully upholstered cut foam back

C. YERGMV	Mid Back Visitor Cantilever Chair
D. YERGP	High Back Task Chair
E. YERGPH	High Back Task Chair with Headrest
F. YERGPV	High Back Visitor Cantilever Chair

Arm Options

G. YERGAA	Black Height Adjustable Arms
H. YERGAC	Black Fixed Arms
I. YERGAD	Chrome Height Adjustable Arms
J. YERGAH	Chrome Disc Fixed Arms
K. YERGAM	Height adjustable Fold Down Arms

Base Options

L. YERGB2	Black Nylon Spider Base
M. YERGB3	Chrome Base
N. YERGB5	Polished Aluminium Base

Ergo Options

YERGCC	Coccyx Cut-Out (Ergotek+ Only)
YERGL	Inflatable Lumbar Support



Unlimited fabrics available

Prices shown are for Era, Phoenix, Rivet & Advantage – see pages 281-284. Please contact us for prices on other fabrics

A

Shown with chrome base option



B

Shown with fold down arms & chrome base option



C

Shown with chrome disc fixed arms



D

Shown with chrome height adjustable arms



E

Shown with chrome height adjustable arms



F

Shown with chrome disc fixed arms



G



H



J



K



L



M



N



Ergonomic Backcare Seating

Posture 150

- The Posture 150 back care chair has been tested to the rigorous strength and stability standard, BS5459 and is guaranteed structurally for 5 years whilst in 24 hour per day use by persons weighing up to 150kg
- The back and seat recline together in a fixed 2:1 ratio. The tension of the recline is adjusted by a rotating handwheel. The recline function can be left unlocked in dynamic freefloat mode. For added comfort the back angle is independently adjustable

A. YPP73	Posture Chair
B. YPP73ADJ	Posture Chair with Arms
C. YPP83	Posture Chair with Adjustable Headrest
D. YPP83ADJ	Posture Chair with Adjustable Headrest and Arms
YPPC	Chrome Base



Unlimited fabrics available

Prices shown are for Era, Phoenix, Rivet & Advantage – see pages 281-284. Please contact us for prices on other fabrics



For seat dimensions see pages 277-280

Rheos Chair

- Wellbeing in the workplace is vital for maximising organisational performance. The Rheos ergonomic chair range has been designed to address the daily physiological problems experienced by office workers
- Large seat with integral coccyx cut out
- Weight activated synchronised mechanism
- Integral seat slide
- Fine tension adjustment
- 5 degree forward seat tilt
- 4 position tilt lock
- Additional 13 degree back angle adjustment
- 2D or 4D arm options
- Black nylon, black aluminium or polished aluminium base

YRHE01	Rheos Wellbeing Medium back chair
YRHE02	Rheos Wellbeing High back chair
YRHE2D	Optional Extra 2D Adjustable Arms
YRHE4D	Optional Extra 4D Adjustable Arms
YRHELU	Optional Extra Inflatible Lumber Support
YRHEHR	Optional Extra Headrest



Unlimited fabrics available

Prices shown are for Era, Phoenix, Rivet & Advantage – see pages 281-284. Please contact us for prices on other fabrics





Conference Seating

Mercury wood frame visitor

- High quality moulded wood frame
- Light Oak effect frame
- 535mm wide
- Stacks 4 high

YVIS04* Mercury Beech Side Chair

YVIS04A* Mercury Beech Armchair

YTWOT Extra Charge for 2-Tone Fabrics from Band 1

* Please specify fabric colour

Colour Options Unlimited fabrics available
Prices shown are for Era, Phoenix, Rivet & Advantage – see pages 281-284. Please contact us for prices on other fabrics



Westbury

- Stylish solid wood frame chair ideally suited for a variety of locations
- Stacks 4 high
- Coated in hygienilac anti-bacterial laquer
- 5 year guarantee (normal use)

YWES01 Westbury Wood Frame Side Chair

YWES02 Westbury Wood Frame Armchair

* Please specify fabric colour

Colour Options Unlimited fabrics available
Prices shown are for Era, Phoenix, Rivet & Advantage – see pages 281-284. Please contact us for prices on other fabrics

5 Year Warranty



For seat dimensions see pages 277-280

Define

- Attractive boardroom chair
- One piece seat and back
- Clear lacquered frame
- 5 year guarantee

YDHAT01* Define 4 Leg Chair

YTWOT Extra Charge for 2-Tone Fabrics from Band 1

* Please specify fabric colour

Colour Options Unlimited fabrics available
Prices shown are for Era, Phoenix, Rivet & Advantage – see pages 281-284. Please contact us for prices on other fabrics

Conference Seating

Venus deluxe beech framed

- Suited for visitors or management suites
- Fully upholstered waterfall seat
- Stylish curved frame
- H480 x W580 x D580mm
- Stacks 4 high

YVIS06* Venus Beech Chair

YTWOT Extra Charge for 2-Tone Fabrics
from Band 1

* Please specify fabric colour



Unlimited fabrics available

Prices shown are for Era, Phoenix, Rivet & Advantage – see pages 281-284. Please contact us for prices on other fabrics



For seat dimensions
see pages 277-280

Galaxy wood frame visitor

- Elegant stacking side or arm chairs
- Crafted hard wood frame
- 5 year guarantee
- H480 x W520 x D560mm
- Stacks 4 high

YVIS05* Galaxy Stacking Side Chair

YVIS05A* Galaxy Armchair

YTWOT Extra Charge for 2-Tone Fabrics
from Band 1

* Please specify fabric colour



Unlimited fabrics available

Prices shown are for Era, Phoenix, Rivet & Advantage – see pages 281-284. Please contact us for prices on other fabrics



5 Year
Warranty

Best
Seller

5 Year
Warranty



Conference Seating

Fleet plus

- Classic conference chair with added quality
- Mesh back chair with fabric upholstered seat
- Arm writing tablets available POA



YFP500MB* Mesh Back Chair

Y600570* Mesh Back Cantilever Chair

* Please specify fabric colour

Seat fabric options



511 Black 501 Cobalt 505 Burgundy



Narrower design allowing 2 chairs to fit under 1200mm wide classroom table

College fleet heavy duty chair

- Heavy duty chair designed for use in colleges and higher education
- Narrower design allowing 2 chairs to fit under 1200mm wide classroom table
- Stackable

YCOFL Chair

YCOFLWT Chair with Writing Tablet

Delivery charge for quantities of less than 10 chairs

For seat dimensions see pages 277-280



Best Seller

Mono stacking chair

- Black welded frame
- Excellent value for money
- Stack up to 5 high



YVIS01* Mono Chair

Y600720* Silver Frame Chair

YVIS01A* Mono Armchair

Y600730* Silver Frame Armchair

* Please specify fabric colour



Unlimited fabrics available

Prices shown are for Era, Phoenix, Rivet & Advantage – see pages 281-284. Please contact us for prices on other fabrics

Conference Seating

Fleet

- A collection of multipurpose stacking chairs suitable for conference, meeting and training rooms, public waiting areas, canteens and schools
- Features include comfortable deep foam, three dimensional waterfall seat, plastic feet to eliminate floor scratching with a choice of black or chrome steel frames
- Stackable up to eight high
- If using with classroom tables, please use the College Fleet chair shown opposite as it is narrower



A. YVIS13	Chair with Black Frame	£57.50	£48.30
B. YVIS15	Chair With Chrome Frame	£60.95	£50.60
YVIS1BK	Chair with Black Moulded Plastic Seat and Back		
YVIS2R	Chair with Red Moulded Plastic Seat and Back		
YVIS3BL	Chair with Blue Moulded Plastic Seat and Back		
YVIS4G	Chair with Green Moulded Plastic Seat and Back		
YVIS5P	Chair, Upholstered Seat and Perforated Plastic Back		
C. YVIS16	Fleet Wood Chair		

Options

YFLET	Optional	Arms
YVIS17	Optional	Writing Tablet
YVISWFA	Writing Tablet & 1 Arm	
YFLETLD	Fixed Linking Device (Pair)	

Please specify fabric colour

Colour Options Unlimited fabrics available
Prices shown are for Era, Phoenix, Rivet & Advantage – see pages 281-284. Please contact us for prices on other fabrics

For seat dimensions see pages 277-280

Fast Track Chair - in stock for faster delivery



Fleet fast track

- Stocked in Black BK, Royal Blue RB, Claret CL

YFLEFT



Fleet with Black Frame



Fleet with Chrome Frame



Fleet Wood Chair



Fleet with Optional Arms



Fleet with Writing Tablet & 1 Arm



Optional Linking Device

Fleet Fast Track Chair Fabric Options

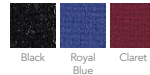

Black Royal Blue Claret



Optional Linking Device



Best Seller



Conference Seating

Response cantilever

- Popular, chrome cantilever stacking visitor's chair
- Stacks 4 high

YVIS10*	Response Cantilever
YVIS10A*	Response Cantilever With Arms
YTWOT	Extra Charge for 2-Tone Fabrics from Band 1

* Please specify fabric colour

Colour Options Unlimited fabrics available
 Prices shown are for Era, Phoenix, Rivet & X2 - see pages 281-284. Please contact us for prices on other fabrics.

For seat dimensions see pages 280-283

A



Note: with chrome frame option

B



Track

- Stacking chair
- Writing tablet option

A. YTRAC1*	Track 4 Leg Chair
B. YTRAC1PU*	Track 4 Leg Chair with PU Arms (Optional Writing Tablet)
YTRACWT	Track Writing Tablet (Option for PU Arm Chair Only)
C. YTRACPP	Track 4 Leg Chair with Polypropylene Arms
YTRAC4C	Track Chrome Frame for 4 Leg Chairs
D. YTRACCA*	Track Cantilever Chair with Arms
YTRACCR	Track Chrome Frame for Cantilever Chair

* Please specify fabric colour

Colour Options Unlimited fabrics available
 Prices shown are for Era, Phoenix, Rivet & Advantage – see pages 281-284. Please contact us for prices on other fabrics.

C



D



Conference Seating



Neptune Chair

- Range of comfortable yet stylish boardroom chairs
- Available in Full back, Small back & Mesh back
- Chrome frame as standard
- Desk clearance of 645mm
- Stacks up to 4 high
- Mesh back available in 7 colours: - Black, Blue, Green, Grey, Orange, Red or White. Please specify at time of order

Full back chair

YNEPFB4	4 legged Chrome frame with arms
YNEPFB3	Conference Chair.Cantilever frame w/arms

Small back chair

YNEPSB4	4 legged chrome frame with arms
YNEPSB3	Cantilever chrome frame with arms

Mesh back chair

YNEPMH4	4 legged chrome frame with arms
YNEPMH3	Cantilever chrome frame with arms



Unlimited fabrics available

Prices shown are for Era, Phoenix, Rivet & X2 - see pages 281-284. Please contact us for prices on other fabrics.

For seat dimensions see pages 277-280





Conference Seating

Cathedral chair

- The Cathedral chair combines comfort and stackability.
- Lightweight
- Stacks 10 high or 25 high on Cathedral trolley

YCATH Chair

YCATHTR Trolley

* Please specify colour



Unlimited fabrics available

Prices shown are for Era, Phoenix, Rivet & Advantage – see pages 281-284. Please contact us for prices on other fabrics



Vogue

- Comfortable side chair with upholstered seat and back
- Chair or stool options
- 4 leg or skid base options

Y612700 4 Leg Chrome Chair

Y612701 4 Leg Chrome Chair with Arms

Y612702 Skid Base Chrome Chair

Y612703 Skid Base Chrome Chair with Tablet

Y612704 Skid Base Chrome Chair with Arms

Y612705 4 Leg Chrome High Stool

Y612706 Skid Base Chrome High Stool



Unlimited fabrics available

Prices shown are for Era, Phoenix, Rivet & Advantage – see pages 281-284. Please contact us for prices on other fabrics



For seat dimensions
see pages 277-280

Conference Seating

5 Year
Warranty

Madrid

- Sled frame training and conference chair
- Madrid offers simple modern style, comfort and reliability.
- Choose from a solid supportive fabric backrest or mesh backrest offering flexibility and breathability. Stackable up to 4 chairs high, both the 4-leg or cantilever base options are available in black or chrome.

- A. MCMMF-B Black Mesh Black Legs
- B. MCMMF-C Black Mesh Chrome Legs
- C. MCMFC-B Black mesh back Black cantilever
- D. MCMFC-C Black mesh back Chrome cantilever
- E. MCMFF-B fabric Back Black Legs
- F. MCMFF-C Fabric Back Chrome Legs
- G. MCMFC-B Fabric Back Black Cantilever
- H. MCMFC-C Fabric Back Chrome Cantilever



* Please specify fabric colour



Unlimited fabrics available
Prices shown are for Era, Phoenix, Rivet & Advantage – see pages 281-284. Please contact us for prices on other fabrics

For seat dimensions
see pages 277-280



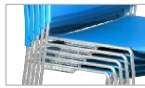

Conference Seating

Stax

High density stacking chair

- Chrome wire frame
- Stacks up to 40 high
- Integral linking on all chairs
- Weight capacity 200kg
- Available in Blue, Black, Grey or White
- Stacking trolley available

Y600530	Blue
Y600540	Black
Y600550	Grey
Y600560	White

Stax trolley

- Stacks 32 chairs high in 2 metres

Y600740

For seat dimensions
see pages 277-280



Roma

- A contemporary and comfortable stacking chair
- Stacks up to 4 high
- Ideal chair for when seating is required on a large scale
- A popular choice for modern school cafes
- Available in Black, Flannel and Nordic as standard, all other colours available to order POA.

Y16716	Roma Chair
--------	------------



Stylish white shell



Upholstered seat pad



White

Conference Seating



Fusion

- Available in Red, Blue, Black, White, Green, Brown and Grey - please specify when ordering

YFUS1	Chrome Frame 4 Leg Chair
YFUS1A	Chrome Frame 4 Leg Chair with Arms
YFUS2	Chrome Frame Sled Base
YFUSTR	Chair Trolley



For seat dimensions
see pages 277-280



Conference Seating

Oslo

- Designer chair with solid beech legs
- Other wood finishes are available, please enquire for details

YOSLHPL Oslo White Seat Shell

YOSLBV Oslo Beech Veneer Seat Shell

YOSLUP Oslo Fully Upholstered Chair

Colour Options Unlimited fabrics available
 Prices shown are for Era, Phoenix, Rivet & Advantage – see pages 281-284. Please contact us for prices on other fabrics



Narvik upholstered

- Fully upholstered chair
- Deep foamed seat for extra comfort
- Hand-crafted from sustainable timber
- Robust construction, ideal for contract and retail locations
- Available in Natural Oak
- Choice of fabrics, vinyls and leathers

Y600580 Oak Frame Upholstered Chair

Y600590 Oak Frame Upholstered Stool

Colour Options Unlimited fabrics available
 Prices shown are for Era, Phoenix, Rivet & Advantage – see pages 281-284. Please contact us for prices on other fabrics

For seat dimensions see pages 277-280



Molde wooden

- Comfortable contoured seat
- Available in Natural Oak
- Wooden Plyform seat
- Seat colours Black, White, Blue, Red, Orange, Yellow, Lime Green, Purple & anthracite

Y600610 Plyform Seat Chair

Y600620 Plyform Seat Stool

Conference Seating

Topaz

- Chrome frame chair with upholstered inner back and plastic back outer
- Weight capacity 110kg

YTOP1U	4 Legs
YTOP1UA	4 Legs & Arms
YTOP2UA	Cantilever Frame & Arms

* Please specify fabric colour



Unlimited fabrics available

Prices shown are for Era, Phoenix, Rivet & Advantage – see pages 281-284. Please contact us for prices on other fabrics



5 Year Warranty

Topaz mesh

- Chrome frame chair with upholstered seat and mesh back
- Weight capacity 110kg

YTOP1M	4 Legs
YTOP1MA	4 Legs and Arms
YTOP2MA	Cantilever Frame & Arms
YTOPTR	Trolley (for 4 Leg Options Only)

* Please specify fabric colour



Unlimited fabrics available

Prices shown are for Era, Phoenix, Rivet & Advantage – see pages 281-284. Please contact us for prices on other fabrics



5 Year Warranty

For seat dimensions see pages 277-280

Topaz mobile

- Chrome Frame chair on castors
- Available with Upholstered back or Mesh back

YTOPWM	Mesh Back
YTOPWU	Upholstered Back
YTOPWMA	Mesh Back & Arms
YTOPWUA	Upholstered Back & Arms



Unlimited fabrics available

Prices shown are for Era, Phoenix, Rivet & Advantage – see pages 281-284. Please contact us for prices on other fabrics

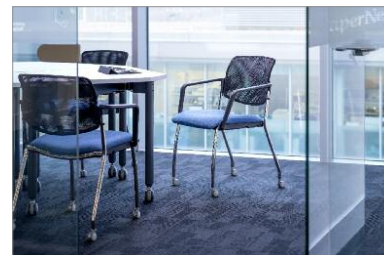



Executive Conference Seating

Eames Style Chair

- The Eames Style executive chair and matching visitors chair is perfect for adding a touch of style to your office or conference room. The classic black ribbed faux leather design is available with a high back or medium back and will add some much-needed comfort to employees and visitors, with chrome arms and a chrome base that will always look sleek and stylish
- Contemporary design with top quality black faux leather
- Front support feet for anti-tilt
- Matching leather executive chair available
- Stylish chrome arms & cantilever frame
- Stylish, classic design suitable for any office or meeting room
- Weight capacity 115kg

YEAMC Cantilever Conference Chair in Black

5 Year Warranty



Milan

- Wide comfortable seat and backrest
- Natural split leather faced
- Black only
- Polished chrome frame

YMILBK Milan Cantilever Chair



Prague

MCPMP-NA/B Black mesh back, Black 4 leg pyramid swivel base

MCPMA-NA/B Black mesh back, Black 4 leg pyramid swivel base with auto return

MCPMW-NA/B Black mesh back, Black 4 leg pyramid swivel base with castors

MCPMP-OH/B Black mesh back, Black 4 leg pyramid swivel base, with fixed plastic armrests (pair)

MCPMA-OH/B Black mesh back, Black 4 leg pyramid swivel base with auto return, with fixed plastic armrests (pair)

MCPMW-OH/B Black mesh back, Black 4 leg pyramid swivel base with castors, with fixed plastic armrests (pair)

For seat dimensions see pages 277-280

Executive Conference Seating

Chelsea

- A superb quality cantilever chair
- Aluminium base and arms
- PU arm pads

YCHEL02



5 Year
Warranty

Racer

- Stylish cantilever chair
- Black PU

YRAC02



For seat dimensions
see pages 277-280

Bordeaux cantilever chair

- Luxury cantilever conference chair
- Chrome frame
- Arm pads

Y600240 Fabric

Y600245 Black Leather



seating size guide



Code	o/a height	o/a width	o/a depth	seat height	Code	o/a height	o/a width	o/a depth	seat height	Code	o/a height	o/a width	o/a depth	seat height
Reception & Staffroom Seating					Page 223					YREC102CH 770 1290 630 455				
					YMOT1	-	-	-	-	Y600100	770	680	490	490
					YMOTTS	-	-	-	-	Y600102	770	1100	610	490
					YMOTTLA	730	660	745	395	Page 229				
					YMOTTRA	730	660	745	395	YLEG1B	840	720	680	460
					YMOTTA	730	740	745	395	YLEG2B	840	1240	680	460
					Page 224					YLEG1C	840	720	680	460
					YJAZZBL	770	565	640	-	YLEG2C	840	1240	680	460
					YJAZZGR	770	565	640	-	YPSL1	790	640	630	440
					YJAZZMU	770	565	640	-	Page 230				
					YJAZZRD	770	565	640	-	YVIV01	840	460	460	510
					Page 225					YVIV02	840	460	460	510
					YJASMU	760	580	550	-	YJAVAST	225	440	440	-
					YJASBL	760	580	550	-	YJJAVA	350	750	750	-
					YJASGR	760	580	550	-	Page 231				
					YJASPERBL	860	640	760	-	YTIG1	860	590	-	420
					YJASPERGR	860	640	760	-	YTIG2	860	590	-	420
					YJASPERMU	860	640	760	-	YTIG4	860	590	-	420
					Page 226					YTIG5	365	750	-	-
					YRALI	820	520	660	410	YCON2	810	570	560	430
					YIMP1	810	520	670	410	YCON3	810	570	560	430
					YIMPA	810	630	670	410	YCON4	820	570	560	470
					YCC50	890	570	660	440	YCONS	780	570	560	-
					YCC55	890	650	660	440	Page 232				
					YCC255	890	1160	660	440	YYSTRUMPET	790	725	620	-
					YCC20	350	550	550	-	YSSQUARE	790	725	620	-
					YCC30	350	1100	550	-	YSSPIDER	790	725	620	-
					Page 227					Y606300	780	600	580	440
					YMER1A	745	590	690	420	Y606301	780	600	580	440
					YMER1AA	745	640	690	420	Y606302	780	600	580	440
					YMER1RA	745	620	690	420	Y606303	875	600	580	395-535
					YMER1LA	745	620	690	420	Y607200	830	620	600	480
					YMER2AA	745	1175	690	420	Y607201	830	620	600	480
					YMER1M	890	590	735	420	Y607202	830	620	600	480
					YMER1MA	890	640	735	420	Page 233				
					YMER1MRA	890	620	735	420	YML011	670	860	770	410
					YMER1MLA	890	620	735	420	YML012	670	1400	770	410
					YMER2MA	890	1320	735	420	YPLA001	680	900	900	440
					YMER1H	1020	590	770	420	YPLA002	680	1450	900	440
					YMER1HA	1020	640	770	420	YCHESERFIELDS	760	1065	865	-
					YMERSTA	335	566	566	-	YCHESTERFIELD	760	1625	865	-
					YMERRTA	340	1132	565	-	YCHESTERFELDT	760	1980	865	-
					YMERPL	890	570	640	430	Page 234				
					YMERPLA	890	620	640	430	YVAL01	830	785	810	440
					YMERPH	980	570	680	430	YVAL02	830	1325	810	440
					YMERPHA	980	620	680	430	YVAL03	830	1870	810	440
					Page 228					YAZU001	900	930	920	460
					YREC11	780	660	600	460	YAZU002	900	1510	920	460
					YREC20	780	1250	600	460	YAZU003	900	2090	920	460
					YREC12W	440	520	520	-	Page 235				
					YREC12G	440	520	520	-	YSA001F	730	830	730	440
					YREC10BK	770	700	630	455					
					YREC10CH	770	700	630	455					
					YREC102BK	770	1290	630	455					

Code	o/a height	o/a width	o/a depth	seat height	Code	o/a height	o/a width	o/a depth	seat height	Code	o/a height	o/a width	o/a depth	seat height
YSA002F	730	1370	730	440	YRAFHCX	1300	1190	715	450	Y620105	2035	2060	750	-
YSA003F	730	1900	730	440	YRAFHC	1300	715	715	450	Y620110	2035	2060	1400	-
YSA001L	730	830	730	440	YRAFHV	1300	115	715	-	Y620115	2200	2060	750	-
YSA002L	730	1370	730	440	YRAFHVT	1300	665	715	-	Y620120	2200	2060	1382	-
YSA003L	730	1900	730	440	YRAFHDT	1300	1215	715	-	Page 247				
Page 236					Page 240									
Y600110	770	800	720	440	YWHIS1	1200	1290	820	440	Y620200	1820	2236	700	-
Y600115	530	800	130	440	YWHIS2	1200	1150	820	440	Y620205	1820	2236	1300	-
Y600120	770	1200	720	440	YWHIS3	1200	1100	820	440	Y620210	1820	2236	2100	-
Y600125	530	1200	130	440	Page 241					Y620220	1524	2236	701	-
Y600130	770	1600	720	440	YCITB1	-	600	670	440	Y620225	1524	2236	1300	-
Y600135	530	1600	130	440	YCITDB1	-	1200	670	440	Page 248				
Y600140	770	800	720	440	YCITTB1	-	1800	670	440	Y620300	1168	1854	1335	-
Y600145	530	800	130	440	YCIT1	-	600	670	440	Y620305	1168	1854	1335	-
Y600150	770	1500	800	440	YCIT2	-	1200	670	440	Page 249				
Y600155	530	1500	130	440	YCIT3	-	1800	670	440	YLU21	390	525	525	390
Y600160	770	800	1320	440	YCIT4	-	1090	670	440	YLU22	390	760	525	390
Y600165	530	800	130	440	YCITC1	-	770	770	440	YLU23	390	760	-	390
Page 237					YCITCON1	-	1090	670	440	YLU24	390	525	525	390
Y600170	770	1200	1320	440	YCITTAB2	-	880	880	440	YLU25	390	1080	-	390
Y600175	530	1200	130	440	YCITCTB	-	-	-	-	YLU26	390	870	525	390
Y600180	770	1600	1320	440	YCITCTW	-	-	-	-	YLU27	390	525	460	390
Y600185	530	1600	130	440	YCITA1	-	170	470	170	YLU28	-	-	-	-
Y600190	770	1080	720	440	YCITA2W	-	170	470	170	YLP21	490	525	525	490
Y600195	530	1080	130	440	YCITA2B	-	170	470	170	YLP22	490	760	525	490
Y600200	770	1080	1320	440	Page 242					YLP23	490	760	-	490
Y600205	530	1080	130	440	Y602000	800	690	690	-	YLP24	490	525	525	490
Y600210	440	1320	660	440	Y602010	800	690	690	-	YLP25	490	1080	-	490
Y600220	770	1080	720	440	Y602020	800	690	690	-	YLP26	490	1035	525	490
Y600225	530	1080	130	440	Y602030	800	690	690	-	YLP27	490	525	525	490
Page 238					Y602040	1000	690	690	-					
YRAF1	460	670	715	450	Y602050	1000	690	690	-					
YRAF1B	830	670	715	450	Y602060	1000	690	690	-					
YRAF1BR	830	800	715	450	Y602070	1000	690	690	-					
YRAF1BL	830	800	715	450	Page 243									
YRAF1BA	830	900	715	450	Y609100	1140	770	740	-					
YRAF1CB	830	715	715	450	Y609101	1140	770	740	-					
YRAF2	460	1340	715	450	Y609102	1140	770	740	-					
YRAF2B	830	1340	715	450	Y609103	890	770	740	-					
YRAF2BR	830	1455	715	450	Y609104	890	770	740	-					
YRAF2BL	830	1455	715	450	Y609105	890	770	740	-					
YRAF2BA	830	1570	715	450	Page 244									
YRAF3	460	715	715	450	YR630000	2100	1200	770	-					
YRAFT	430	700	700	-	YR630010	2100	1500	770	-					
YRAF3B	810	1840	715	-	YR630020	2100	2100	770	-					
YRAF3BA	810	2100	715	-	YR630030	2100	2100	1550	-					
Page 239					YR630040	2100	2100	2320	-					
YRAFH1	1300	670	715	450	Page 245									
YRAFH1R	1300	800	715	450	Y609800	2320	1500	1968	-					
YRAFH1L	1300	800	715	450	Y609801	2320	2110	1968	-					
YRAFH1S	1300	900	715	450	Page 246									
YRAFH2	1300	1340	715	450	Y620100	2035	1215	750	-					
YRAFH2R	1300	1455	715	450										
YRAFH2L	1300	1455	715	450										
YRAFH2S	1300	1570	715	450										
YRAFHCV	1300	1190	715	450										

seating size guide



Code	o/a height	o/a width	o/a depth	seat height	Code	o/a height	o/a width	o/a depth	seat height	Code	o/a height	o/a width	o/a depth	seat height						
YCWAYHU	750	663	522	-	Page 257	YHYP1A	1120	670	-	500-600	YHYP1A	1120	670	-	500-600					
YCWAYLU	450	663	522	-	YBV32	1065	490	550	-	YHYP1V	990	540	540	490	YHYP1V	990	540	590	490	
Page 250					YBV32ADJ	1065	640	550	-	YHYP1VA	990	540	620	490	YHYP1VFA	990	540	620	490	
Y600380	510	265	440	-	YBVC30	1040	490	550	-	YHYP2	1120	510	-	500-600	YHYP2F	1120	590	-	500-600	
Page 251						YHYP2A	1120	670	-	500-600	YHYP2V	990	540	540	490	YHYP2VA	990	540	590	490
Y608108	390	680	680	-	Operator Seating	YHYP2VFA	990	540	620	490	Page 260									
Y608109	390	1020	680	-	Page 252	YTRA17	1070	535	570	510-630	YTRA17A	1070	690	570	510-630					
Operator Seating					YEMAG01B	930	580	510	430-550											
Page 252					YBREL B	1250	520	630	480-610											
YBRELBA	1250	640	630	480-610	YBRELAAJ	1250	670	630	480-610											
Page 253					Task Seating															
Y20106	860	500	550	475-605	Page 258	YBEX30	1025	630	580	-	YTRA11	1030	520	600	510-590					
Y20111	860	620	550	475-605	YBV40	915	550	570	-	YTRA11FA	1030	640	600	510-590						
Y20113	860	650	550	475-605	YBV40A	915	600	570	-	YTRA11A	1030	640	600	510-590						
Y20108	970	500	550	475-605	YBV50	915	550	570	-	YTRA12	1030	520	600	510-590						
Y20110	970	620	550	475-605	YBV50A	915	600	570	-	YTRA12FA	1030	640	600	510-590						
Y20112	970	650	550	475-605	Y600420	990	490	500	440	YTRA12A	1030	640	600	510-590						
Y20301	1110	500	570	620-870	Y600430	990	610	500	440	YCHE01	1045	520	600	510-590						
Y20201	980	540	660	465	Y600440	990	490	500	490	YCHE01F	1045	640	600	510-590						
Page 254					Y600450	990	610	500	490	YCHE01AA	1045	640	600	510-590						
YGLSHB	1170	-	-	450-580						YCHE01D	1045	660	600	510-590						
YGLSHMA	1170	-	-	450-580						YCHE02	1045	520	600	510-590						
YGLSHAT	1170	-	-	450-580						YCHE02F	1045	640	600	510-590						
YMPS66	1000	520	630	480-610						YCHE01A	1045	640	600	510-590						
YMPS66FA	1000	640	630	480-610						YCHEC01D	1045	660	600	510-590						
YMPS66ADJ	1000	670	630	480-610	Page 259	YHYP1	1120	510	-	500-600	YHYP1F	1120	590	-	500-600					
Page 255																				
YES0622	1100	510	610	460-560																
YES0622FA	1100	510	610	460-560																
YES0622ADJ	1100	510	610	460-560																
YEV50622	970	540	640	490																
YEV50622A	970	590	640	490																
Page 256																				
YCHI1B	955	500	570	475-605																
YCHI1BFX	955	620	570	475-605																
YCHI1BAD	955	650	570	475-605																
YCHI1BFA	955	640	570	475-605																
YCHI1C	955	500	570	475-605																
YCHI1CAD	955	625	570	475-605																
YCHI1CFA	955	640	570	475-605																
YCHI2B	1095	500	570	620-870																
YCHI2BAD	1095	650	570	620-870																
YCHI2BFA	1095	640	570	620-870																
Y600300	1050	520	600	-																
Y600301	1050	520	660	-																
Y600302	1050	520	660	-																
Y600303	1050	520	600	-																

Code	o/a height	o/a width	o/a depth	seat height	Code	o/a height	o/a width	o/a depth	seat height	Code	o/a height	o/a width	o/a depth	seat height
Manager & Executive Seating					Page 268					Page 274				
Page 262					YVIS05A 840 530 635 485					YKRATR - - - -				
Y610500	1230	660	610	460-560	YFP500MB	810	540	580	470	Page 274	840	490	525	450
YRAC01	1210	650	620	480-560	Y600570	810	505	500	460	Y600530	840	490	525	450
YNEO1BK	1180	685	685	535-625	YCOFL	810	470	510	470	Y600540	840	490	525	450
					YCOFLWLT	810	470	510	470	Y600560	840	490	525	450
					YVIS01	800	470	530	470	Y600740	600	700	380	-
					Y600720	800	470	530	470	Y16716	800	495	540	-
					YVIS01A	800	570	530	470					
					Y600730	800	470	530	470					
					Page 269					Page 275				
					YVIS13	810	540	580	470	YFUS1	845	440	535	460
					YVIS15	810	540	580	470	YFUS1A	845	490	535	460
					YVISP1BK	810	540	580	470	YFUS2	845	440	510	460
					YVISP2R	810	540	580	470	YFUS2A	845	585	510	460
					YVISP3BL	810	540	580	470	YFUSTR	406	715	645	-
					YVISP4G	810	540	580	470					
					YVISP5P	810	540	580	470	Page 276				
					YVIS16	810	540	580	470	YOSLHPL	780	430	500	460
					YFLEFT	810	540	580	470	YOSLBV	780	430	500	460
										YOSLUP	780	430	500	460
					Page 270					Y600580	880	430	530	460
					YVIS10	850	510	560	515	Y600590	1050	460	530	820
					YVIS10A	850	610	560	515	Y600610	880	430	530	460
					YTRAC1	840	515	560	480	Y600620	1050	460	530	820
					YTRAC1PU	840	590	560	480					
					YTRACPP	840	590	560	480	Page 277				
					YTRACCA	840	530	560	480	YTOP1U	860	-	570	480
										YTOP1UA	860	580	570	480
					Page 271					YTOP2UA	860	-	600	470
					YNEPFB4	955	555	590	-	YTOP1M	860	-	570	480
					YNEPFB4	955	555	590	-	YTOP1MA	860	580	570	480
					YNEPSB4	865	555	590	-	YTOP2MA	860	-	600	470
					YNEPSBC	865	555	590	-	YTOPTR	-	-	-	-
					YNEPMH4	830	555	590	-	YTOPPWM	860	500	550	-
					YNEPMHC	830	555	590	-	YTOPWU	860	500	550	-
										YTOPWMA	860	580	550	-
					Page 272					YTOPWUA	860	580	550	-
					YCATH	810	540	580	470	Page 278				
					YCATHTR	-	-	-	-	YEAMC	870	560	575	-
					Y612700	850	590	570	-	YMILBK	940	565	600	545
					Y612701	850	600	570	-	YAMD2	960	720	630	490
					Y612702	850	590	550	-					
					Y612703	850	600	710	-	Page 279				
					Y612704	850	580	570	-	YCHEL02	1025	585	640	450
					Y612705	1180	590	560	-	YRAC02	995	585	670	490
					Y612706	1180	590	560	-	Y600240	1040	630	650	470
										Y600245	1040	630	650	470
					Page 273									
					YKRA1	800	490	560	440					
					YKRA1S	800	490	560	480					
					YKRA1F	800	490	560	480					
					YKRA2	800	520	560	440					
					YKRA2S	800	520	560	480					
					YKRA2F	800	520	560	480					
					YKRA3	800	550	560	440					
					YKRA3S	800	550	560	480					
					YKRA3F	800	550	560	480					



seating size guide

All dimensions shown in mm. Please ask for assistance

Seating

Phoenix

- Phoenix is a simple crepe weave fabric
- Available in 21 top selling colours
- Made from 100% polyester
- This hardwearing fabric is rated at 100,000 Martindale abrasion cycles



Please phone for a free swatch

Due to limitations in the printing process when fabric is shown photographically, we recommend that you ask for actual fabric samples before ordering.

Standard Fabrics Range



Task seating



Cigarette & Match



Year Guarantee



Rivet

- Rivet is a fixating fabric which connects with the modern collaborative workplace and forms a bridge between textile traditions and future innovation.
- Rivet is a lightly textured hopsack which emulates the swathe of suiting in a well-heeled synthetic. Made from 100% REPREVE®, a brand of recycled polyester made from used plastic bottles.



Task seating



Soft seating



Cigarette & Match



Washable



environmental



year guarantee



For a wider range of fabric options, please call us today.

Era

- Era is a subtle, two tone polyester fabric containing stretch in both directions for ease of upholstery.
- The baby herringbone weave offers an understated contemporary texture while its colouring technique provides close up intrigue. The palette incorporates playful brights and sophisticated muted tones.

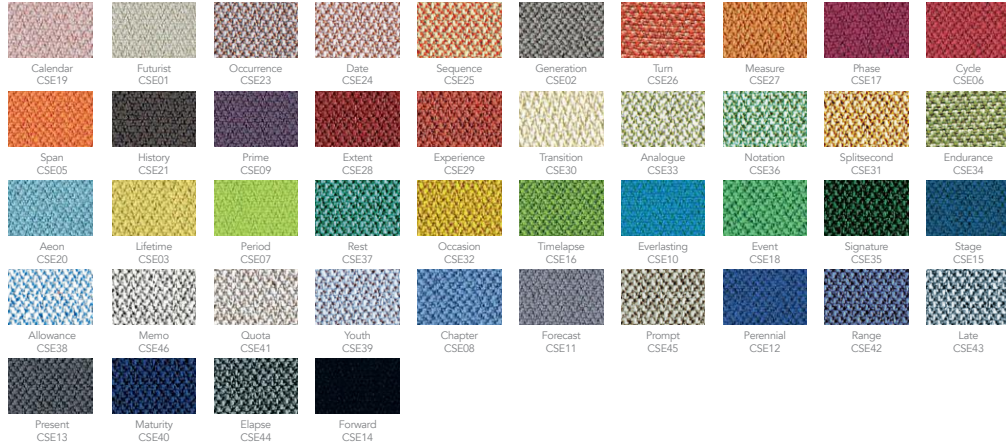

Standard Fabrics Range



Advantage

- Advantage is the UK's top selling Low Hazard seating fabric
- Its high performance durability comes from its blend of 30% wool and 70% gylmene - a synthetic fibre originally developed for use in broadloom carpets
- It is rated at 75,000 Martindale abrasion cycles



For a wider range of fabric options, please call us today.

Seating

Premium fabrics - ALL SEATING IN THESE FABRICS AVAILABLE POA

Intervene performance fabric



Special Fabrics Range

Intervene plain



Intervene texture



Please phone with your choice of seating for prices in these fabrics

X2 plus fabric options

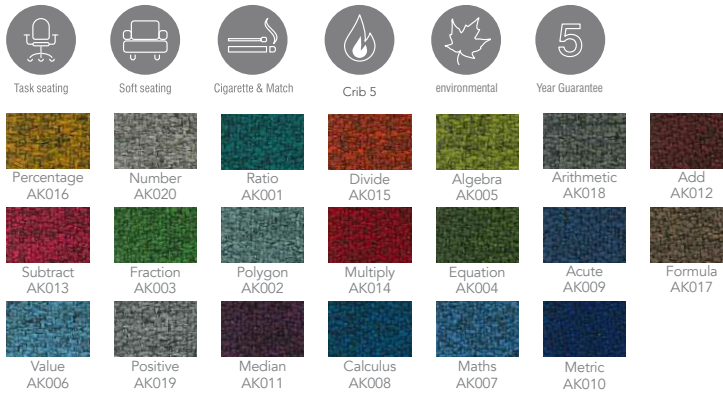

Due to limitations in the printing process when fabric is shown photographically, we recommend that you ask for actual fabric samples before ordering.

Premium fabrics - ALL SEATING IN THESE FABRICS AVAILABLE POA

Just colours vinyls

Just Colour harmonizes with both contemporary and traditional interiors. The broad palette encompasses modern neutrals, warm classics to vivid bright colours.

Designed to withstand the rigorous demands of both heavy domestic and contract upholstery, Just Colour is suitable for a wide variety of applications.

- Flame Retardancy: BS5852 Ignition Source 5, BS7176 Medium Hazard, S.I. 1988 No. 1324 schedule 4&5, EN1021-1&2, CS-25, FMVSS 302 and IMO A 652 (16)
- Abrasion: 100,000+

Special Fabrics Range



Task seating



Soft seating



Crib 5



Anti-Microbial



Stain repellent



Water Proof



Bleach Cleanable



year guarantee



Due to limitations in the printing process when fabric is shown photographically, we recommend that you ask for actual fabric samples before ordering.



Let us create a warm welcome to your school or office.
Clean, flowing lines give a confident, professional impression your visitors are sure to remember. Call us today to discuss your requirements.

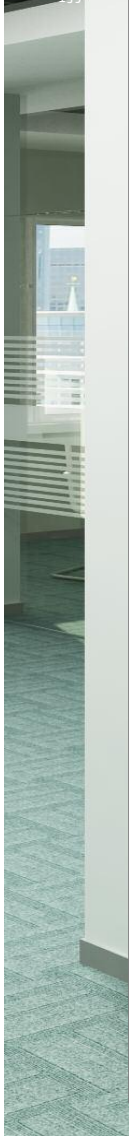

SPACES TAYLORED

Receptions

Colorado	287
Tromsø	288
The Alpen	289
Venice	290
Venice Ice	291
Abstract	292
Oval	293
Luna	293
Castello	294
Lunae	295
Bespoke	296
Reception Screens	297
Plants	298

[Main Content Page](#)

Receptions

First impressions count don't they? What do visitors see when they arrive at your school? It needs to be something that endorses the excellence that exists throughout the school, warmly welcomes and is pleasant for staff to work at.

We can help you achieve that in reception areas large and small from a simple one piece unit to a fully bespoke design unique to you.

Let us help you achieve the great result you want - why not call us now and we can begin the process at once.



Due to limitations in the printing process, wood and colour finishes shown throughout the catalogue may not be representative of actual colour. Samples are available on request.



Colorado

- Ideal for school receptions or libraries, Colorado counters are beautifully crafted in durable, wood effect melamine
- Traditional look with practical features please ask for specific quote
- Satin anodised kickplate option
- A range of matching pedestals and bookcases is also available

Wood & colour finishes may not be representative of actual colours - please ask for a sample. Other colours available - please enquire.

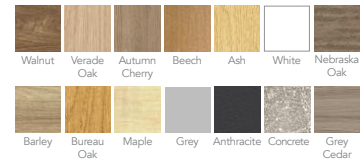

Page Link - see page
Matching office desking
315-321





Tromsø

Timeless design in a modern office.

- A flexible modular system available in different shapes, straight and curved, also, in several height combinations for different-sized offices
- Choose from different textures and colours to create your desired style reception: secretive and minimalist or cosy and harmonious





The Alpen

Evoke the feel of nature in your spaces with this reception desk inspired by the shapes of the Alps. Crafted not only to make guests feel welcome but also to suit the demands of a modern reception area. The Alpen integrates functionality with grace and timeless design, gains guests' attention and makes for an atmosphere of comfort and trust.

The high gloss front and timeless colours delight with their severity, which is additionally emphasized by an illuminated metal kick plate. The glass reception combines aesthetics with functionality, and the modular construction creates a variety of straight and corner sets. By employing a low module segment with an overhang top, the reception eases access for disabled users.

Thanks to these features Alpen fulfills the requirements of different types of spaces, from small receptions to large lobbies.

Front, Counter & Body Options



Black Glass Silver Glass White Glass

Receptions



Venice

- Stylish and sleek yet practical, Venice counters are the choice for the discerning school desiring to make a statement
- The option of a glass top and chrome strip detailing enhances the contemporary appeal, showcasing the brilliant white laminate to maximum effect
- Modular construction enables countless configuration options
- Subtle LED lighting adds a sophisticated style and gives the impression the room is bigger





Venice ice

- A range of cool white reception furniture that makes a stunning visual impact and can be enhanced further by the use of low level mood lighting
- Due to a wide range of available elements, the shape of the Venice Ice range can be configured in various forms. From a circle through an arch, to angular or simple blocks
- The body of the counter includes hidden handy shelves and a wide working table with enough space for a computer or printer
- Subtle LED lighting adds a sophisticated style and gives the impression the room is bigger

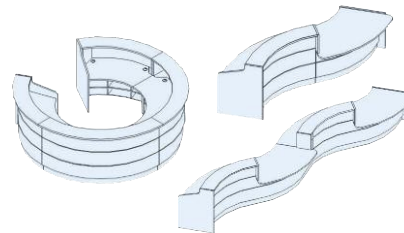



Abstract

A range of contemporary modular reception furniture that uses bold, abstract lines for dramatic effect.

This desk with its original form should be enough to arrange every reception hall. The white, metal openwork wreathing subtly round the body and contrasting with the highlighted interior is a very characteristic element of the reception counter.

Very effective in dark rooms, the LED lighting can be changed to different colours to create different moods.





Luna

- Using three rectangular elements, these can be joined side by side to create a longer unit
- The modules equipped with LED-lighting add delicacy and improve working conditions in darker rooms
- Brushed aluminium used in the kickplate perfectly matches the white colour of the reception counter

Y500110 Luna Reception Counter

Y500111 Luna Drawer with Lock

Available in:



Oval

The Oval is a multifunctional reception desk dedicated to small rooms or entrances where there is minimal space.

- The lowered desk top makes it easy to communicate with persons in a sitting position
- The common part of the desk top is tempered frosted glass, which allows the user to deal with documents easily and provides trouble-free communication
- The lifted part includes a hidden computer stand and a vertical shelf for files and documents
- Available in Cocoa or Chestnut finish panels with white body
- Available left or right handed
- 5 year warranty

Y500100 Oval Right Handed

Y500105 Oval Left Handed

Available in

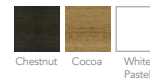



Castello

- A refreshing reception system combining high gloss HPL with MFC in a choice of six finishes
- It is a modular solution that allows the creation of compact or large reception counters depending on requirements
- It comes with an optional top highlighted with LED lighting

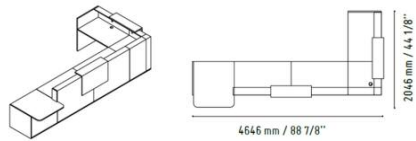

Available in:

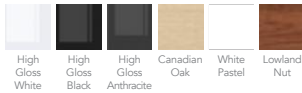

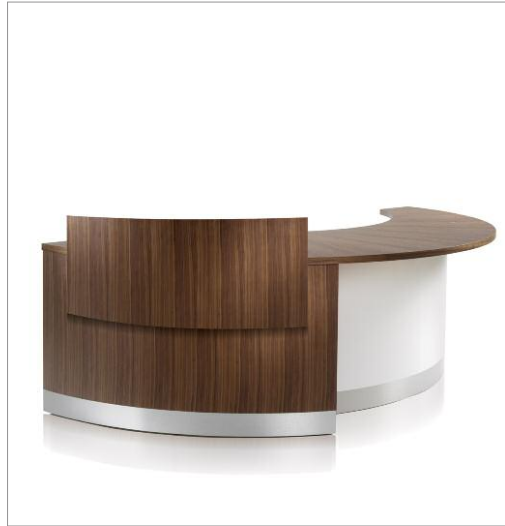

Lunae

Inspired by the demand for compact reception furniture, this crescent shaped desk is ideal. Featuring a genuine wood veneer counter top which tapers from 800mm to 240mm, Crescent desks are able to neatly fit into corners and tight spaces with a small footprint.

For Dramatic visual effect, the veneered top of the Lunae reception furniture can be teamed with a recessed counter front in a contrasting laminate instead of a matching veneer.

Colour adjustable 'mood lighting' fitted under the desk top, looks particularly effective in reception areas with low ambient light.

Finishes available:

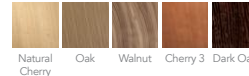

Natural Cherry Oak Walnut Cherry 3 Dark Oak

Bespoke Reception Furniture

- We are able to work to your exact requirements or architect's specifications, produced in either real wood veneers or laminated MFC
- At an early stage of planning we cover all aspects including DDA, lighting, induction loop facilities, and then tailor specific finishes, to enhance and create the stunning impression you want to portray
- A huge range of colours and wood finishes are available

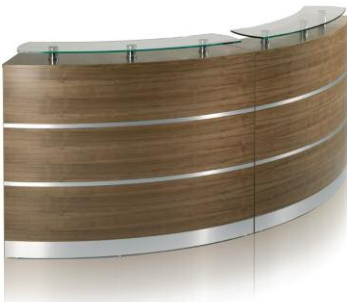



Bespoke Reception Screens

Abuse to reception staff sadly is now a common occurrence faced by educational institutions and the security desk screens help to eliminate the risk to staff

- A bespoke solution enhances security to an existing reception area or as part of a newbuild or renovation project
- Screens can be designed with safeguarding in mind and can help comply with Ofsted recommendations
- A huge range of colours and finishes are available and can include curved or toughened glass



Office Plants

Office plants and interior landscaping are an important element in workspace design. This offers huge benefits to staff engagement and well-being whilst simultaneously enhancing your image to prospective parents, clients and visitors.

This selection of replica plants offers an opportunity to gain all the aesthetic benefits. Replica plants are virtually zero maintenance, made with the finest materials and manufactured with expertise so that most would struggle to tell the difference from the real thing.

There are many benefits to furnishing your office or workspace environment with plants. The introduction of natural forms has been proven to create a calming influence which in turn improves concentration – and ultimately productivity.

If you would prefer the real thing, please get in contact with us.



All dimensions shown as height x width x depth

A. Y500210	Ivy Tower in Slate Square - pack of 2
B. YPLGFL	Natural Stemmed Green Ficus Liana Tapered Square Metal 1600 x 250 x 250mm
C. YPLSV	Sansevieria in White Maxi Pot, Internal Use
D. YPGASV	Green Aloe in Silver Pot, Internal Use
E. YPLBP*	Bird of Paradise, Internal Use, 1300 x 300 x 300mm

F. YPLGAS*	Green Aloe in Tapered Circle, Internal Use 1250 x 300 x 300mm
YPLGAL*	1450 x 300 x 300mm
G. YPLPBE*	Pyramid Buxus, External Use, 1200 x 300 x 300mm
H. YPLSBE*	Spiral Buxus, External Use, 1600 x 350 x 350mm
I. YPLPP*	Phoenix Palm, Internal Use, 2200 x 350 x 350mm

* Any RAL Colour for Pot



Is your office giving the right Impression?

Talk to us about the best solutions for your offices, meeting rooms, staff work rooms and conference facilities.



SPACES TAYLORED

Office Furniture & Janitorial

Alpine	301-314
Nova	310,311
Colorado	315-337
Orbit	337-342
Vermont	343
Galway	344
Wexford	344
Pigeon Hole Units	345
Screens	346-347
Cable Management	348-300
Storagewall	352-355
Steel Storage	356-364
Safes & Hotbox	365-367
Janitorial	367

[Main Content Page](#)

Office Furniture

In the following pages you will find a beautiful and practical choice of tables of every size and type.

Folding and flip-top for multi-use areas, boardroom tables for where it gets serious and much more - let's not forget coffee tables and staff room needs.

Need help planning? - ring us today, we are always delighted to help.



Due to limitations in the printing process, wood and colour finishes shown throughout the catalogue may not be representative of actual colour. Samples are available on request.



Alpine Panel Leg Desking

A complete and versatile range of well-priced, traditionally styled office furniture.

- 25mm work tops with 3mm edging, solid 25mm leg and modesty panels
- Six finishes to choose from and a range of matching pedestals, storage and meeting tables (see other pages)
- Cable trays also available (see page 350)
- Prices shown are for Group 1 finish

5 Year Warranty

Straight workstations



*UK Stock
Delivery
3-5 Working
Days

DDA081		L800mm
DDA101		L1000mm
DDA121*		L1200mm
DDA141*		L1400mm
DDA161*		L1600mm
DDA181*		L1800mm

Wave workstations 1000mm deep



800mm deep also available

DDL122	Left	L1200mm
DDR122	Right	L1200mm
DDL142	Left	L1400mm
DDR142	Right	L1400mm
DDL162	Left	L1600mm
DDR162	Right	L1600mm

Crescent workstations



*UK Stock
Delivery
3-5 Working
Days

DDL141*	Left	L1400 x W1200mm
DDR141*	Right	L1400 x W1200mm
DDL161*	Left	L1600 x W1200mm
DDR161*	Right	L1600 x W1200mm
DDL181*	Left	L1800 x W1200mm
DDR181*	Right	L1800 x W1200mm
DDB120	Symmetrical Corner	L1200 x W1200 x D600mm

Workstation extensions

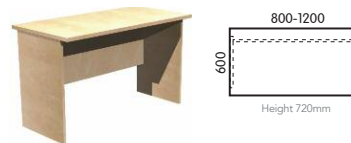

DDD082		L800mm
DDD102		L1000mm
DDD122		L1200mm

COMPLETE ALPINE RANGE

Cantilever Leg Desks	306	Nova Bench Desking	311
Pedestals	313	Meeting Tables	307-309
Conference Tables	309		



Alpine Cantilever Desking - See page 306

Alpine Tables MFC Finishes

Group 1 Colours



W4 W2/3 W2/4 W6 W9

Group 2 Colours



W10 W5/1 W11 W12

Wood & colour finishes may not be representative of actual colours - please ask for a sample

Page Link - see pages
For Teacher's
Desks



Alpine Cantilever Leg Desking

A superb range of cantilever twin leg desking. This attractive range includes almost 30 different desk shapes and sizes to fit every situation. Quality 25mm tops in a choice of seven finishes.

- Prices shown are for Group 1 finish
- Frames are also available in a white finish - please ask

5 Year Warranty



Straight workstations

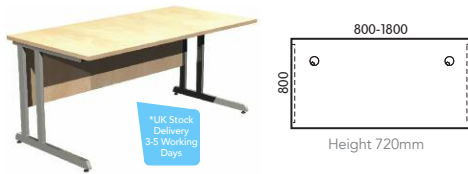

DCA081	L800mm
DCA101	L1000mm
DCA121*	L1200mm
DCA141*	L1400mm
DCA161*	L1600mm
DCA181*	L1800mm

Wave workstations 1000

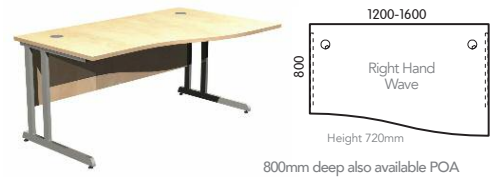

DCL122	Left	L1200mm
DCR122	Right	L1200mm
DCL142	Left	L1400mm
DCR142	Right	L1400mm
DCL162	Left	L1600mm
DCR162	Right	L1600mm

Crescent workstations



DCL141*	Left	L1400 x W1200mm
DCR141*	Right	L1400 x W1200mm
DCL161*	Left	L1600 x W1200mm
DCR161*	Right	L1600 x W1200mm
DCL181*	Left	L1800 x W1200mm
DCR181*	Right	L1800 x W1200mm
DCB120	Symmetrical Corner	L1200 x W1200 x D600mm

Plastic push-fit leg insert

Smart triple compartment vertical cable trunk, push fits into leg.

Recommended for use with modesty fix cable trays - see page 352



OEVCRW	W100 x H600mm	White	£22.00
OEVCRS	W100 x H600mm	Silver	£22.00

Workstations extensions



DCD081	L800mm
DCD101	L1000mm
DCD121	L1200mm

COMPLETE ALPINE RANGE

Panel Leg Desks	304	Nova Bench Desking	311
Pedestals	313	Meeting Tables	307-309
Conference Tables	309		

Alpine Tilt Top Tables

TABLES - TILT TOP 700MM

DEEP

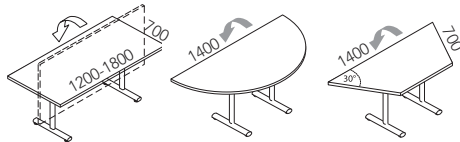

With silver tilt-top base with castors

YDFT122 Rectangular Table, 2 Leg, W1200

YDFT142 Rectangular Table, 2 Leg, W1400

YDFT162 Rectangular Table, 2 Leg, W1600

YDFT182 Rectangular table, 2 Leg, W1800

YDFT183 Half Round Table, 2 Leg, W1400

YDFT185 Trapezoid Table, 2 Leg, W1400



Alpine Tables MFC Finishes

Group 1 Colours



Beech

Amber Oak

White Oak

White

Pearl Grey

Group 2 Colours



Grey Nordic Wood

Sand Ash

Cubanite Grey

Tobacco Walnut

W4

W2/3

W2/4

W6

W9

W10

W5/1

W11

W12

Wood & colour finishes may not be representative of actual colours - please ask for a sample

Page Link - see page

Alpine Coffee Tables

248



800MM DEEP

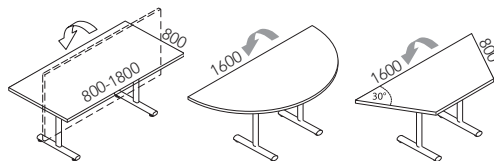

With silver tilt-top base with castors

YDFT121 Rectangular Table, 2 Leg, W1200

YDFT141 Rectangular Table, 2 Leg, W1400

YDFT161 Rectangular Table, 2 Leg, W1600

YDFT181 Rectangular Table, 2 Leg, W1800

YDFT180 Half round Table, 2 Leg, W1600

YDFT184 Trapezoid Table, 2 leg, W1600





Alpine Meeting & Conference Tables

Smart and business like, Alpine Conference tables are perfect for when you need a touch of class on a modest budget.

All our Alpine conference tables come with 25mm tops, 3mm lippings, a sturdy timber panel base or pole legs with a metal underframe. For an added touch of class why not have a pedestal column base?

- Prices shown are for Group 1 finish

A



A. Round tables - pole leg

- H720mm

YCZM100	Pole Legs, Ø1000mm
YCZM120	Pole Legs, Ø1200mm

B



B. Round tables - panel leg

- H720mm

YCZM101	Panel Leg, Ø1000mm
YCZM121	Panel Leg, Ø1200mm

C



C. Round tables - pedestal base

- H720mm

YCOM090	Metal Pedestal Base, Ø900mm
YCOM100	Metal Pedestal Base, Ø1000mm
YCOM120	Metal Pedestal Base, Ø1200mm

Alpine Tables MFC Finishes

Group 1 Colours



W4 W2/3 W2/4 W6 W9

Group 2 Colours



W10 W5/1 W11 W12

Wood & colour finishes may not be representative of actual colours - please ask for a sample

Alpine Meeting & Conference Tables

Smart and business like, Alpine Conference tables are perfect for when you need a touch of class on a modest budget.

All our Alpine conference tables come with 25mm tops, 3mm lippings, a sturdy timber panel base or pole legs with a metal underframe. For an added touch of class why not have a pedestal column base?



A. D-end tables

- Choice of pole or panel legs
- D1000 x H720mm

YCZM201	Panel Leg, L2000
YCZM241	Panel Leg, L2400
YCZM200	Pole Legs, L2000 (Attached to Metal Underframe)
YCZM240	Pole Legs, L2400 (Attached to Metal Underframe)



B. Square-end tables

- Choice of pole or panel legs
- D1000 x H720mm

YCZM203	Panel Leg, L2000
YCZM202	Pole Legs, L2000 (Attached to Metal Underframe)



C. Barrel top table

- Choice of pole or panel legs
- D1200 x H720mm

YCZM243	Panel Leg, L2400
YCZM242	Pole Legs, L2400 (Attached to Metal Underframe)



The following table is for guidance only

Style	1200mm	1400mm	1600mm	1800mm	2000mm	2400mm
Square End	4 Seater	4 Seater	4 Seater	6 Seater	6 Seater	8 Seater
D End				6 Seater	8 Seater	8 Seater
Barrel Top			6 Seater	6 Seater	8 Seater	8 Seater
Circular	4/5 Seater	5-7 Seater	6-8 Seater			



Nova Conference Tables

- Modern, minimal and charming
- Nova conference tables have the huge benefit of no intermediate legs along the sides no matter how long you make the table. Freedom of movement with comfort, especially when you have to pack that extra person in
- Ultra modern technical design includes full optional cable management for IT supported conferences. Don't miss the matching Nova bench desking system on page 308
- Infinitely extendable using extensions YCNM144 and YCNM164
- Prices shown are for Group 1 finish

Alpine Tables MFC Finishes

Group 1 Colours

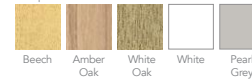

Group 2 Colours

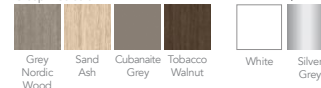

Frame Options



Wood & colour finishes may not be representative of actual colours - please ask for a sample

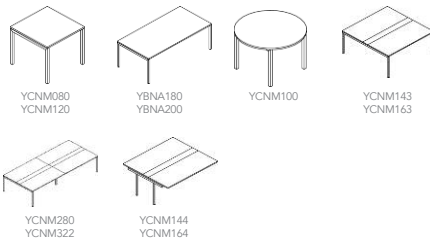

Tables

YCNM080	L800 x W800 x H740mm	YCNM163	L1600 x W1640 x H740mm
YCNM120	L1200 x W1200 x H740mm	YCNM280	L2800 x W1640 x H740mm
YBNA180	L1800 x W1000 x H740mm	YCNM322	L3200 x W1640 x H740mm
YBNA200	L2000 x W1000 x H740mm	YCNM144	L1400 x W1640 x H740mm
YCNM100	Diameter 1000 x H740mm	YCNM164	L1600 x W1640 x H740mm
YCNM143	L1400 x W1640 x H740mm		



Accessories

Cable Trays

YZNZ001	L1400 x W180mm
YZNZ002	L1600 x W180mm
YZNZ004	L1400 x W180mm
YZNZ005	L1600 x W180mm
YZNZ007	L1400 x W180mm
YZNZ008	L1600 x W180mm

Cable Ports

YZNZ010	L320 x W130mm
---------	---------------

Shared Cable Trays for Bench Desking

YCTS110	L1100 x W180 x H110mm
---------	-----------------------

Nova Bench Desking System

Beauty in simplicity. Nova combines clean and minimal aesthetics with great functionality. The Nova shared leg system keeps costs and assembly time down to a minimum. Recessed legs on all central locations make for clear, easy working. Three desktop options - scoop back for easy, low-cost cable management, tops with cutouts for large cable ports or straight tops for the ultimate in clean lines - all at the same price.

5 Year Warranty

- Prices shown are for Group 1 finish

Desk Top Colour Options

Group 1 Colours



Wood & colour finishes may not be representative of actual colours - please ask for a sample

Group 2 Colours



Grey Nordic Wood, Sand Ash, Cubanite Grey, Tobacco Walnut

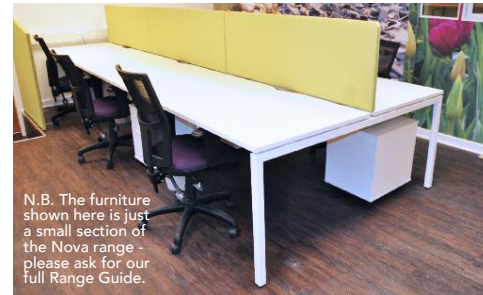

N.B. The furniture shown here is just a small section of the Nova range - please ask for our full Range Guide.

DESK



Desk with scoop back

DNA125	L1200mm
DNA145	L1400mm
DNA165	L1600mm
DNA185	L1800mm

2 DESK SQUARE BENCH



2 desk square bench with scoop backs

DNS126	L1200mm
DNS146	L1400mm
DNS166	L1600mm
DNS186	L1800mm

2 DESK LONG BENCH



2 desk long bench with scoop backs

DNS248	L2400mm
DNS288	L2800mm
DNS328	L3200mm
DNS368	L3600mm

4 DESK SQUARE BENCH



4 desk square bench with scoop backs

DNS247	L2400mm
DNS287	L2800mm
DNS327	L3200mm
DNS367	L3600mm

EXTENSION FOR LONG BENCH



Long desk extension with scoop back

DND128	L1200mm
DND148	L1400mm
DND168	L1600mm
DND188	L1800mm

All desks also available in 700mm depth. Ideal for IT suites

EXTENSION FOR SQUARE BENCH



Extension for square bench with scoop back

DND127	L1200mm
DND147	L1400mm
DND167	L1600mm
DND187	L1800mm

Nova Screens



FRAMELESS PERSPEX® SCREENS



These unframed Perspex® screens or modesty panels come in an unprecedented choice of 75 colours! The only limit is your imagination.

- Transparent or opaque as standard
- Frosted finish also available, call for prices
- Minimum quantities may apply

DNK124	L1200mm	W1050 x H340
DNK144	L1400mm	W1250 x H340
DNK164	L1600mm	W1450 x H340
DNK184	L1800mm	W1650 x H340

Page Link - see pages

For desk screens



CABLE PORT INSERTS

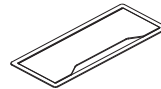

ZNZ010 Metal Lid
L320mm

MFC MODESTY PANELS



MFC modesty panels

DNH120	L1200mm
DNH140	L1400mm
DNH160	L1700mm
DNH180	L1800mm
DNH200	L2000mm

ACCESSORIES - CABLE TRAYS



Cable tray for central dump

CTS110	L1080mm
CTS140	L1400mm

Choice of Silver, White or Anthracite finish



Alpine Pedestals And Desk Height Storage

- Pedestals & desk height storage to complement the Alpine ranges
- A huge choice of pedestals to suit every requirement and situation - don't forget the purpose made pen trays
- Desk height quadrant bookcases add that finishing touch and can double as a meeting point
- All desk height pedestals have height adjustable feet
- Prices shown are for group 1 finish

Group 1 Colours

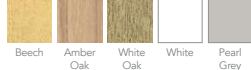

Group 2 Colours

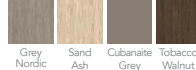

Wood & colour finishes may not be representative of actual colours - please ask for a sample



CONTRACT FIXED PEDESTALS



White finish wooden drawer sides. Metal file frame, central locking
W415 x D500 x H446mm

PSP525	2 Drawer
PSP532	3 Drawer

CONTRACT DESK HEIGHT PEDESTALS



White finish wooden drawer sides. Metal file frame. Central locking
W415 x H720mm

PSS637*	3 Drawer	D600
PSS642	4 Drawer	D600
PSS837	3 Drawer	D800

CONTRACT SMALL MOBILE PEDESTALS



White finish wooden drawer sides. Metal file frame, central locking, mobile castors
W415 x D500 x H510mm

PSR525	2 Drawer
PSR532*	3 Drawer

STANDARD CONTRACT MOBILE PEDESTALS



White finish wooden drawer sides. Metal file frame, central locking, mobile castors
W415 x D500mm

PSR535*	3 Drawer, H638
PSR541	4 Drawer, H638

Page Link - see pages

For steel pedestals

364



HEAVY DUTY DESK HEIGHT PEDESTALS



Metal drawer sides and solid drawer bottoms. Metal file frame, central locking, anti-tilt mechanism
W430 x H720mm

PUS635	3 Drawer	D600
PUS642	4 Drawer	D600
PUS835	3 Drawer	D800

PEN TRAYS



Organise paper, envelopes and forms in pedestal drawers.

ZZZ004	For PSR & PSS, D235mm
ZZZ006	For PUR & PUS, D250mm

5 Year
Warranty

SHALLOW BOOKCASE



W800 x D400 x H720mm
PXA420 Shallow Open Front Unit
with 1 Shelf

FILING CABINETS



H720mm



H1020mm



H1320mm

SLIDING DOOR CUPBOARD



W1200 x D600 x H720mm
PXL620 Lockable Sliding Doors.
Internal Shelf

W500mm x D600

PEX627* 2 Drawer, H720mm (Desk Height)

PEX637* 3 Drawer, H1020mm

PEX647* 4 Drawer, H1320mm

*UK Stock
Delivery
3-5 Working
Days

DEEP TAMBOUR CUPBOARDS 1000MM WIDE, 475MM DEEP

- Supplied empty – see below for accessories.
- For plinth options see page 316. Wooden plinth will be supplied by default

DEEP CUPBOARD



W800 x D600 x H720mm
PXD620 Cupboard with Locking
Doors & 1 Shelf



U2T101



U3T101



U5T101

DEEP TAMBOUR ACCESSORIES

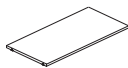

U0Z001
Shelf

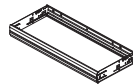

U0Z004
Pull out Filing Cradle, A4
or Foolscap Filing

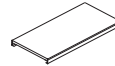

U0Z003
Lateral Filing Shelf, A4
or Foolscap Filing

Page Link - see pages

For Steel Storage



Alpine X-Range

- A choice of over 60 cupboard and bookcase combinations to match all the Alpine ranges
- All storage units have 19mm carcasses, 25mm tops to complement desking, height adjustable levellers and finished backs, i.e. may be used as room dividers. Includes height adjustable shelves
- All cupboards include locks
- For plinth options see page 313. Wooden plinth will be supplied by default
- X-RANGE STORAGE is 425mm deep except where otherwise indicated
- 9 MFC finishes available – see page 310



600mm WIDE, 5 LEVEL

H1954mm



X5N061 Bookcase
 X5C061 Cupboard RH Handle
 X5C062 Cupboard LH Handle
 X5H061 Cupboard RH Handle
 X5H062 Cupboard LH Handle

800mm WIDE, 2 LEVEL

H834mm



X2N081 Bookcase
 X2C081 Cupboard
 X2F081 Sidefiler

600mm WIDE, 6 LEVEL (must be fixed back to wall)

H2320mm



X6N061 Bookcase
 X6C061 Cupboard RH Handle
 X6C062 Cupboard LH Handle

800mm WIDE, 4 LEVEL

H1588mm



X4N081 Bookcase
 X4H081 Cupboard
 X4C081 Cupboard

800mm WIDE, 3 LEVEL

H1211mm



X3N081 Bookcase
 X3C081* Cupboard

Office Furniture

For plinth options see bottom of page. Wooden plinth will be supplied by default.

800mm WIDE, 5 LEVEL

H1954mm



X5N081
Bookcase



X5H081
Cupboard



X5C081
Cupboard



X5F081
Bookcase & Sidefiler,
A4 Files Only



X5G081
Cupboard with
Glass Doors

800mm WIDE, 6 LEVEL (must be fixed back to wall)

H2320mm



X6N081
Bookcase



X6C081
Cupboard



X6H081
Cupboard

WALL MOUNTED UNIT, 1 SHELF

H370mm



X1N081
Wall Unit



X1C081
Wall Unit with Doors

1000mm WIDE, 2 LEVEL

H834mm



X2N101
Bookcase



X2C101
Cupboard



X2F101
Sidefiler



X2T101 Tambour
Cupboard



X2S101
Cupboard

BASE OPTIONS (X RANGE ONLY)

All base options are available at no extra cost.



PLINTH BASE

Wooden plinth base with hidden adjustable feet for levelling purposes. NB This option is the standard base on all units unless otherwise specified.



NOVA FEET

Square, tubular metal feet, adjustable for levelling purposes. Available in White (E), Silver (M), and Dark Grey (T1).



PLASTIC FEET

Black plastic feet, adjustable feet for levelling purposes. NB This foot option is smaller than the others and therefore lowers the overall unit height by 57mm.



5 Year
Warranty

For plinth options see page 313. Wooden plinth will be supplied by default.

1000mm WIDE, 3 LEVEL

H1200mm



X3S101 Sliding Door Cupboard



X3C101 Cupboard



X3T101 Tambour Door Cupboard

1200mm WIDE, 2/3 LEVEL



H834mm

X2S121 Cupboard



H1200mm

X3S121 Sliding Door Cupboard



H754mm

X2N121 Bookcase Top Unit

1000mm WIDE, 5 LEVEL

H1954mm



X5N101 Bookcase



X5C101* Cupboard

*UK Stock Delivery 3-5 Working Days

1200mm WIDE, 5 LEVEL

H1954mm



X5N121 Bookcase



X5C121 Cupboard



X5S121 Sliding Door Cupboard

1000mm WIDE, 6 LEVEL (must be fixed back to wall)

H2320mm



X6N101 Bookcase



X6C101 Cupboard

1200mm WIDE, 6 LEVEL (must be fixed back to wall)

H2320mm



X6N121 Bookcase



X6C121 Cupboard

10 Year
Warranty

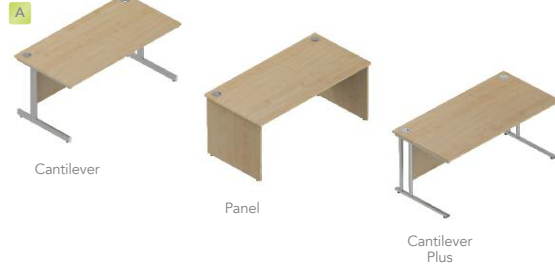

Page Link - see page
For Desk Ends **321**



See page 316, opposite for wood finish options

Colorado Desking

Colorado tables are available with integrated modesty panels and a choice of 3 leg options - Cantilever, Panel or Cantilever Plus. When ordering please add the suffix code C, P or X to the product code to denote the leg style you require as follows:

Cantilever: Code 'C' - Single leg in graphite (G) or silver (S)
 Panel : Code 'P' - Panel leg in chosen board finish
 Cantilever Plus: Code 'X' - Twin upright legs in white (W) or silver (S)

For example, order code YD08-8XW for a rectangular desk with Cantilever Plus legs in White.

Please note that if no leg colour is specified silver will be supplied as standard.

Cable ports with optional trays or risers enable cable management.

A. Rectangular desks 800mm deep

- YUFP-8 fixed pedestals can be fitted to either side of all 800mm deep desks except D08-8 & D10-8

Code	Dimensions W x D x H
YD08-8	800 x 800 x 727
YD10-8	1000 x 800 x 727
YD12-8	1200 x 800 x 727
YD14-8	1400 x 800 x 727
YD16-8	1600 x 800 x 727
YD18-8	1800 x 800 x 727

B. Rectangular desks 600mm deep

- YUFP-6 fixed pedestals can be fitted to either side of all 600mm deep desks except D08-6 & D10-6

Code	Dimensions W x D x H
YD08-6	800 x 600 x 727
YD10-6	1000 x 600 x 727
YD12-6	1200 x 600 x 727
YD14-6	1400 x 600 x 727
YD16-6	1600 x 600 x 727
YD18-6	1800 x 600 x 727

C. Bow fronted desks

- Bow fronted desks accept YUFP-8 fixed pedestals

Code	Dimensions W x D x H
YDB16-8	1600 x 900/800 x 727
YDB18-8	1800 x 900/800 x 727



A. Wave desks

- Available in LH or RH (RH illustrated)
- Accept fixed pedestals YUFP-6 on side A

Code	Dimensions W x D x H
<u>YWD12-6</u>	<u>1200 x 700/600 x 727</u>
<u>YWD14-6</u>	<u>1400 x 700/600 x 727</u>
<u>YWD16-6</u>	<u>1600 x 700/600 x 727</u>
<u>YWD18-6</u>	<u>1800 x 700/600 x 727</u>



10 Year
Warranty

B. Double wave desks

Code	Dimensions W x D x H
<u>YDWD16-6</u>	<u>1600 x 700/600 x 727</u>
<u>YDWD18-6</u>	<u>1800 x 700/600 x 727</u>

Wood Finish Options

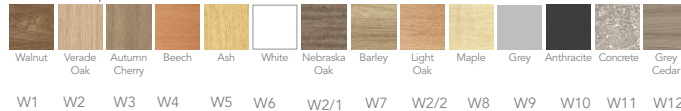

Page Link - see pages
Monitor
arms & CPU 350-351
holders



10 Year
Warranty

A



Cantilever



Panel



Cantilever
Plus

B



Cantilever

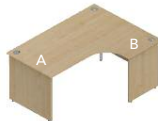

Panel



Cantilever
Plus

C



Cantilever



Panel



Cantilever
Plus

D



Cantilever



Panel



Cantilever
Plus

Page Link - see page
For Desk
Ends 321



Colorado Desking

Colorado tables are available with integrated modesty panels and a choice of 3 leg options - Cantilever, Panel or Cantilever Plus. When ordering please add the suffix code C, P or X to the product code to denote the leg style you require as follows:

Cantilever: Code 'C' - Single leg in graphite (G) or silver (S)

Panel : Code 'P' - Panel leg in chosen board finish

Cantilever Plus: Code 'X' - Twin upright legs in white (W) or silver (S)

For example, order code YD08-8XW for a rectangular desk with Cantilever Plus legs in White.

Please note that if no leg colour is specified silver will be supplied as standard.

Cable ports with optional trays or risers enable cable management.

A. Arc desks

- Available in LH or RH (RH illustrated)
- Accept fixed pedestals YUFP-8 on side A

Code	Dimensions W x D x H
YAD16	1600 x 1000/800 x 727
YAD18	1800 x 1000/800 x 727

B. Combi workstations

- Available in LH or RH (RH illustrated)
- CS16A, CS18A & CS20A accept fixed pedestals YUFP-8 on side A

Code	Dimensions W x D x A x B x H
YCS14A	1400 x 1200 x 800 x 600 x 727
YCS16A	1600 x 1200 x 800 x 600 x 727
YCS18A	1800 x 1200 x 800 x 600 x 727
YCS20A	2000 x 1200 x 800 x 600 x 727

C. 120 degree cluster workstations

- Unhanded
- Do not accept fixed pedestals

Code	Dimensions W x D x A x B x H
YCS3W10-6	1000 x 1000 x 600 x 600 x 727
YCS3W12-6	1200 x 1200 x 600 x 600 x 727
YCS3W12-8	1200 x 1200 x 800 x 800 x 727

D. Cockpit workstations

- Unhanded
- Do not accept fixed pedestals

Code	Dimensions W x D x A x B x H
YCWS16A	1600 x 1200 x 800 x 600 x 727
YCWS18A	1800 x 1200 x 800 x 600 x 727
YCWS20A	2000 x 1200 x 800 x 600 x 727



10 Year
Warranty

A. D-end combi workstations

- Available in LH or RH (RH illustrated)
- Does not accept fixed pedestals

Code	Dimensions W x D x A x B x H
YDCS19	1900 x 1200 x 800 x 600 x 727

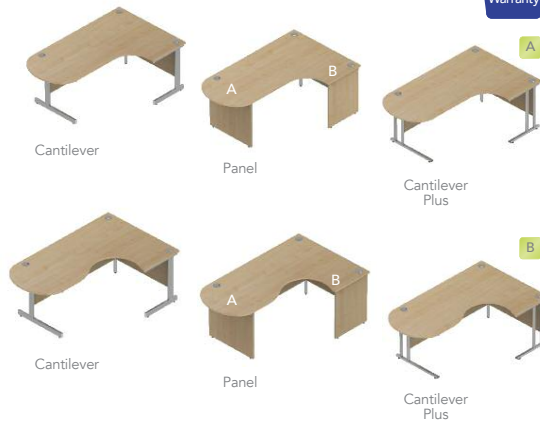

B. D-end cockpit workstations

- Available in LH or RH (RH illustrated)
- Does not accept fixed pedestals

Code	Dimensions W x D x A x B x H
YDCWS19	1900 x 1200 x 800 x 600 x 727

10 Year
Warranty

A



Full Depth
Modesty Panels

B



C



D

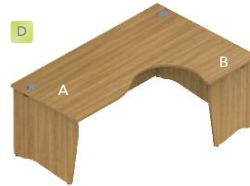

E

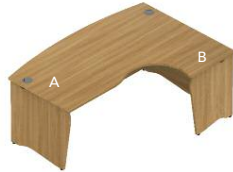

Page Link - see pages

For matching
Colorado
Conference Tables 324-325



Wood Finish Options

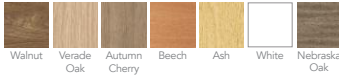

W1 W2 W3 W4 W5 W6 W2/1

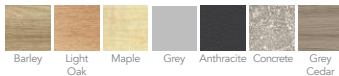

W7 W2/2 W8 W9 W10 W11 W12

Colorado Executive Desking

Colorado executive desking has a stylish panel end leg design with full depth modesty panels. Optional conference extensions are available as are complementary meeting and boardroom tables.

A. Rectangular desks

- Fixed pedestals YUFP2-8 & YUFP3-8 can be fitted to either side of rectangular desks except YPD08-8 and YPD10-8

Code	Dimensions W x D x H
YPD08-8	800 x 800 x 727
YPD10-8	1000 x 800 x 727
YPD12-8	1200 x 800 x 727
YPD14-8	1400 x 800 x 727
YPD16-8	1600 x 800 x 727
YPD18-8	1800 x 800 x 727
YPD20-8	2000 x 800 x 727

B. Bow fronted desks

- Fixed pedestals UFP2-8 & UFP3-8 can be fitted to either side of all bow fronted desks

Code	Dimensions W x D x H
YPD16-8B	1600 x 900/800 x 727
YPD18-8B	1800 x 900/800 x 727
YPD20-8B	2000 x 900/800 x 727

C. Return units

- Available in LH or RH (RH illustrated)
- Return units affixes to either side of rectangular desks except YPD08-8 and YPD10-8 & to all bow fronted desks

Code	Dimensions W x D x H
YPR08-6	800 x 600 x 727
YPR10-6	1000 x 600 x 727
YPR12-6	1200 x 600 x 727

D. Cockpit workstations

- Available in LH or RH (RH illustrated)
- Does not accept fixed pedestals

Code	W x D x A x B x H
YPCWS16A	1600 x 1200 x 800 x 600 x 727
YPCWS18A	1800 x 1200 x 800 x 600 x 727

E. Bow fronted cockpit workstations

- Available in LH or RH (RH illustrated)
- Does not accept fixed pedestals

Code	W x D x A x B x H
YBFCWS16A	1600 x 1300 x 800 x 600 x 727
YBFCWS18A	1800 x 1300 x 800 x 600 x 727



A. D-ended cockpit workstation

- Available in LH or RH (RH illustrated)
- Does not accept fixed pedestals

Code	W x D x A x B x H
YPDCWS19	1900 x 1200 x 800 x 600 x 727

B. Scoop cockpit workstation

- Available in LH or RH (RH illustrated)
- Does not accept fixed pedestals

Code	W x D x A x B x H
YPSCWS19	1900 x 1300 x 800 x 600 x 727

C. Contact cockpit workstation

- Available in LH or RH (RH illustrated)
- Does not accept fixed pedestals

Code	W x D x A x B x H
YPCCWS19	1900 x 1300 x 800 x 600 x 727

D. Bulb cockpit workstation

- Available in LH or RH (RH illustrated)
- Does not accept fixed pedestals

Code	W x D x A x B x H
YPBCWS19	1900 x 1300 x 800 x 600 x 727

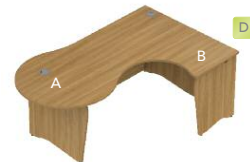
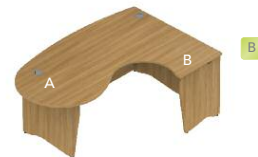

10 Year
Warranty

10 Year
Warranty



Wood Finish Options



Colorado Desk Extensions

A. Colorado extension - bulb

Code	Dimensions Diameter x Height
YCE-B12	1200ø x 727mm

B. Colorado extension - teardrop

Code	Dimensions Diameter x Height
YCE-T12	1200ø x 727mm

C. Colorado extension - d-ended

- YCE-D161 & YCE-D121 conference extensions are used with Split & Intersect screens

Code	Dimensions Diameter x Height
YCE-D160	1600 x 450 x 727
YCE-D161	1610 x 450 x 727
YCE-D120	1200 x 450 x 727
YCE-D121	1210 x 450 x 727

D. Colorado executive extension - bulb

- Bulb conference extension connects to the end of any 800mm deep desk or workstation
- A cutback leg can be used to improve leg room and is purchased separately

Code	Diameter x Height
YPC-E-B12	1200ø x 727mm

E. Colorado executive extension - teardrop

- Teardrop conference extension connects to the end of any 800mm deep desk or workstation
- A cutback leg can be used to improve leg room and is purchased separately

Code	Diameter x Height
YPC-E-T12	1200ø x 727mm

F. Colorado executive pedestal extension

- Available in LH or RH (RH illustrated)
- Pedestal extensions affix to the 600mm return end of the workstations
- Pedestals are not included in the above specification/price
- For pedestals see Universal. (Not designed for use with slimline pedestals)

Code	Diameter x Height
YPP-E-08-6	800 x 600 x 727mm
YPP-E-10-6	1000 x 600 x 727 mm
YPP-E-12-6	1200 x 600 x 727 mm

Colorado Tilt Top Tables

A. Rectangular tilt top tables 800mm deep

- Tip top tables feature a tilting top from a horizontal to a vertical position using a single lever bar with integrated locking action
- Fitted with 2 lockable & 2 non-lockable castors

	Dimensions (mm) W x D x H
YRITR08-8	800 x 800 x 727
YRITR10-8	1000 x 800 x 727
YRITR12-8	1200 x 800 x 727
YRITR14-8	1400 x 800 x 727
YRITR16-8	1600 x 800 x 727
YRITR18-8	1800 x 800 x 727



B. Rectangular tilt top tables 600mm deep

	Dimensions (mm) W x D x H
YRITR08-6	600 x 600 x 727
YRITR10-6	1000 x 600 x 727
YRITR12-6	1200 x 600 x 727
YRITR14-6	1400 x 600 x 727
YRITR16-6	1600 x 600 x 727
YRITR18-6	1800 x 600 x 727

C. Trapezoidal tilt top tables

- Internal angles of the trapezoidal are 60° & 120°
- The depth is the length along the angled side

	Dimensions (mm) W x D x H
YRITZ12-6	1200 x 600 x 727
YRITZ16-8	1600 x 800 x 727

D. Semi-circular tilt top tables

	Dimensions (mm) W x D x H
YRITS12-6	1200 x 600 x 727
YRITS16-8	1600 x 800 x 727

E. Circular tilt top tables

	Diameter x Height (mm)
YRITC10	1000ø x 727



Wood Finish Options

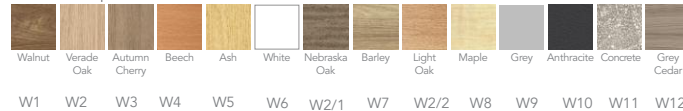

IMPORTANT

When ordering, please specify the leg colour and wood finish you require. Leg frames are available in Silver or White



Colorado Pole Leg Tables

A range of multipurpose tables with fully welded frames and 40mm round tubular legs. Finished in 25mm MFC with 2mm ABS edging.

A. Multipurpose square tables

	W x D (mm)
YMTR06-6	600 x 600
YMTR07-7	750 x 750
YMTR08-8	800 x 800

B. Multipurpose rectangular tables

	W x D (mm)
YMTR12-6	1200 x 600
YMTR15-7	1500 x 750
YMTR10-8	1000 x 800
YMTR12-8	1200 x 800
YMTR14-8	1400 x 800
YMTR16-8	1600 x 800
YMTR18-8	1800 x 800

C. Multipurpose trapezoidal tables

	W x D (mm)
YMTZ12-6	1200 x 600
YMTZ15-7	1500 x 750
YMTZ16-8	1600 x 800

* Internal angles 60° / 120°.

D. Multipurpose semi-circular tables

	W x D (mm)
YMTS12-6	1200 x 600
YMTS15-7	1500 x 750
YMTS16-8	1600 x 800

E. Multipurpose circular tables

	Diameter (mm)
YMTC09	900ø
YMTC12	1200ø

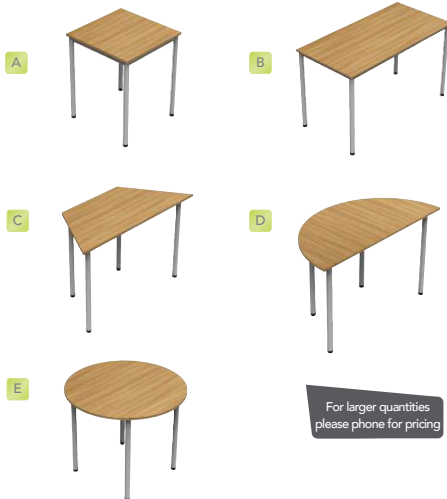

Wood Finish Options



IMPORTANT:

When ordering, please specify the leg colour and table height you require.

Leg frames are available in Graphite, Silver or White. Frame heights: 460, 530, 590, 640, 710, 727 & 760mm high

Colorado Totem Base Table

- Stylish conference, meeting or breakout tables to blend in with all the Colorado Furniture.
- Available with circular or a squircle pillar base.
- Other sizes available on request.

A. Conference Tables

Rectangular	W x D x H
Y660900	1600 x 800 x 727
Y660901	1800 x 800 x 727
Y660902	2000 x 800 x 727
Circular	Diameter x H
Y660908	800Ø x 727
Y660909	1000Ø x 727
Y660910	1200Ø x 727
Barrel	W x D x H
Y660915	1600 x 1000/800
Y660916	1800 x 1000/800
Y660917	2000 x 1000/800



B. Boardroom

Double D-ended	W x D x H
Y660920	6 Seater 2000 x 1000 x 727
Y660921	8 Seater 2400 x 1000 x 727
Y660924	10 Seater* 3200 x 1200 x 727
Y660925	12 Seater* 4000 x 1200 x 727
Y660927	16 Seater* 5600 x 1200 x 727
Y660929	20 Seater* 7200 x 1200 x 727

*Tops Supplied in 2 pieces



C. Breakout & Reception

- Silver or white frames

Square	W x D x H
Y660935	600 x 600 x 407
Y660936	800 x 800 x 407
Circular	Diameter x H
Y660939	600Ø x 407
Y660940	800Ø x 407
Rectangular	W x D x H
Y660945	900 x 450 x 407
Y660946	1200 x 600 x 407
Poseur	Diameter x H
Y660949	600Ø x 1107
Y660950	800Ø x 1107





Colorado Tables

Colorado tables are available with a choice of 3 leg options - Cantilever, Panel or Cantilever Plus. When ordering please add the suffix code X, P or C to the product code to denote the leg style you require as follows:

Cantilever: Code 'C' - Single leg in graphite (G) or silver (S)
 Panel: Code 'P' - Panel leg in chosen board finish
 Cantilever Plus: Code 'X' - Twin upright legs in white (W) or silver (S)

For example, order code YCTR12-8XW for a conference table with Cantilever Plus legs in White.
 Please note that if no leg colour is specified silver will be supplied as standard.



See page 322

Wood finishes: Ash, Autumn Cherry, Beech, Barley, Grey, Light Oak, Maple, Verade Oak, Nebraska Oak, Anthracite, Concrete, Grey Cedar, Walnut or White.

A. Rectangular tables

Code	Dimensions W x D x Hmm
YCTR12-8	1200 x 800 x 727
YCTR14-8	1400 x 800 x 727
YCTR16-8*	1600 x 800 x 727
YCTR18-8*	1800 x 800 x 727
YCTR20-8*	2000 x 800 x 727

- Legs are inset by 200mm from the ends of the table
- * Also available with cutout for one standard AE-EPM-2P2D power module (please request power module cutout when ordering)

B. Barrel tables

Code	Dimensions W x D x Hmm
YCTB16-8*	1600 x 800 x 727
YCTB18-8*	1800 x 800 x 727
YCTB20-8*	2000 x 800 x 727

- Legs are inset by 200mm from the ends of the table
- * Also available with cutout for one standard AE-EPM-2P2D power module (please request power module cutout when ordering)

C. Double d-ended tables

Code	Dimensions W x D x Hmm
YBD6*	1800 x 1200 x 727
YBD8*	2400 x 1200 x 727

- Legs are inset by 200mm from the ends of the table
- * Also available with cutout for one standard AE-EPM-2P2D power module (please request power module cutout when ordering)

Colorado Executive Tables

- Stylish range of conference and meeting tables to match with the Colorado Executive Furniture
- Attractive shaped leg design

A. Conference tables

Rectangular	W x D x Hmm
YPCTR128	1200 x 800 x 727
YPCTR148	1400 x 800 x 727
YPCTR168	1600 x 800 x 727
YPCTR188	1800 x 800 x 727

- Legs are inset by 200mm from the ends of the table

Circular	W x D x Hmm
YPCTC10	1000Ø x 727
YPCTC12	1200Ø x 727
YPCTC15	1500Ø x 727

Barrel	W x D x Hmm
YPCTB16	1600 x 1000/800 x 727
YPCTB18	1800 x 1000/800 x 727
YPCTB20	2000 x 1000/800 x 727

- Legs are inset by 200mm from the ends of the table

B. Boardroom tables

Double D-Ended	W x D x Hmm
YPBD6*	6 Seater 1800 x 1200 x 727
YPBD8*	8 Seater 2400 x 1200 x 727
YPBD10*	10 Seater 3200 x 1200 x 727
YPBD12*	12 Seater 4000 x 1200 x 727
YPBD14*	14 Seater 4800 x 1200 x 727
YPBD16**	16 Seater 5600 x 1200 x 727
YPBD18***	18 Seater 6400 x 1200 x 727
YPBD20***	20 Seater 7200 x 1200 x 727

* Also available with cutout for one standard AE-EPM-2P2D power module

** Also available with cutout for two standard AE-EPM-2P2D power modules

*** Also available with cutout for two standard AE-EPM-2P2D power modules

- Please request power module cutout when ordering
- Legs are inset by 500mm from the ends of the table



Colour Options

See page 322



A

B

Larger tables may be supplied in more than one piece

HomeFit[®]

Working from home. You want to, but that place at the dining table really isn't all that good for your back. And you don't have room for a separate desk either. This is about to change with HomeFit[®]. From a small cabinet to a seated or standing workstation in the blink of an eye!



HomeFit[®] as a cabinet against the wall



HomeFit[®] as sit/stand workstation

Dimensions W x D x H

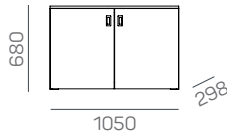

HomeFit[®] - cabinet

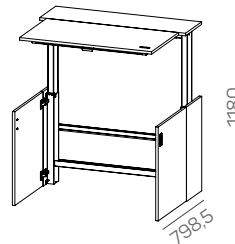

HomeFit[®] - workstation

- sit/stand desk, adjustable in height between 68 and 118 cm frame
- the frame and height adjustment is made of black metal
- aluminium handle
- anti-collision height adjustment (adjustment stops automatically in the event of counter pressure)
- door lock in open position (The right door automatically locks when opened to prevent the furniture from tipping over. The lock can be released with a simple foot movement.)
- doors fitted with castors for easy opening and stability when opened
- convenient metal storage tray for laptop and other accessories
- HomeFit[®] is delivered fully assembled
- HomeFit[®] is delivered in a cardboard box

HomeFit

Code

HOMEFIT1 Sit Stand Desk cupboard POA



Fixed pedestals

- 800mm deep

Code	Dimensions W x D x H
YUFP2-8	2 Drawer 416 x 558 x 482
YUFP3-8	3 Drawer 416 x 558 x 482



Fixed pedestals

- 600mm deep

Code	Dimensions W x D x H
YUFP2-6	2 Drawer 416 x 473 x 482
YUFP3-6	3 Drawer 416 x 473 x 482

Colorado Storage



Mobile low pedestals

- Mobile, low under desk

Code	Dimensions W x D x H
YUMP2	2 Drawer 420 x 568 x 542
YUMP3	3 Drawer 420 x 568 x 542



Mobile midi pedestals

- Mobile, midi under desk

Code	Dimensions W x D x H
YUMMP3	3 Drawer 420 x 568 x 620
YUMMP4	4 Drawer 420 x 568 x 620



Mobile tall pedestals

- Mobile, tall under desk

Code	Dimensions W x D x H
YUTMP3	3 Drawer 420 x 568 x 697
YUTMP4	4 Drawer 420 x 568 x 697



Slimline pedestals

- Mobile, tall, slimline under desk

Code	Dimensions W x D x H
YUTMP3R	3 Drawer 320 x 568 x 697
YUTMP4R	4 Drawer 320 x 568 x 697



Desk high pedestals

- Static, desk high - 600mm deep

Code	Dimensions W x D x H
YUDHP63	3 Drawer 420 x 600 x 727
YUDHP64	4 Drawer 420 x 600 x 727



Slimline pedestals

- Static, slimline desk high

Code	Dimensions W x D x H
YUDHP63R	3 Drawer 320 x 600 x 727
YUDHP64R	4 Drawer 320 x 600 x 727



Desk high pedestals

- Static, desk high - 800mm deep

Code	Dimensions W x D x H
YUDHP83	3 Drawer 420 x 800 x 727
YUDHP84	4 Drawer 420 x 800 x 727



Under desk pedestals

- Mobile, tall under desk

Code	Dimensions W x D x H
YUTMP3SD	3 Drawer 420 x 528 x 697
YUTMP4SD	4 Drawer 420 x 528 x 697

These pedestals are Heavy Duty



Desk high pedestals

- Static, desk high - 600mm deep

Code	Dimensions W x D x H
YUDHP63SD	3 Drawer 420 x 600 x 727
YUDHP64SD	4 Drawer 420 x 600 x 727

These pedestals are Heavy Duty



Desk high pedestals

- Static, desk high - 800mm deep

Code	Dimensions W x D x H
YUDHP83SD	3 Drawer 420 x 800 x 727
YUDHP84SD	4 Drawer 420 x 800 x 727

These pedestals are Heavy Duty

Colorado Storage



Bookcases

- Bookcases fitted with 1 adjustable shelf as standard

Code	Dimensions W x D x H
YUBCU08-8	Open Fronted 800 x 360 x 887
YUBCU09-8	Open Fronted 960 x 360 x 887
YUBCGD09-8	Glass Doors 960 x 360 x 887



Bookcase shelves

Code	Dimensions W x D x H
YUBC-WS08	800 x 360
YUBC-WS09	960 x 360



Filing cabinets

- UFC3 illustrated
- Filing cabinets are fitted with anti-tilt mechanism

Code	Dimensions W x D x H
YUFC2	2 Drawer 470 x 600 x 727
YUFC3	3 Drawer 470 x 600 x 1041
YUFC4	4 Drawer 470 x 600 x 1362



Side filing units

Code	Dimensions W x D x H
YUSF08	2 Drawer 800 x 600 x 727



Plan chest

- Supplied with 1 deep and 5 shallow steel drawers

Code	Dimensions W x D x H
YUPC10	6 Drawer 1000 x 800 x 727



Desk ends

- Radial tambour
- Suitable for A4 files only (maximum height 324mm)

Code	Dimensions W x D x H
YURCUT08	1 Fixed Shelf 800 x 800 x 727



Desk ends

- Radial open fronted
- Suitable for A4 files only (maximum height 324mm)

Code	Dimensions W x D x H
YURCU06	1 Fixed Shelf 600 x 600 x 727
YURCU08	1 Fixed Shelf 800 x 800 x 727



Desk ends

- Elliptical open fronted
- Available in LH or RH (RH illustrated)
- Suitable for A4 files only (max height 324mm)

Code	Dimensions W x D x H
YUECU06	1 Fixed Shelf 600 x 600 x 727
YUECU08	1 Fixed Shelf 800 x 600 x 727



Desktop organiser

- Height to underside of shelf is 330mm

Code	Dimensions W x D x H
YUDTO5	500 x 300 x 420
YUDTO12	1200 x 300 x 420
YUDTO14	1400 x 300 x 420
YUDTO16	1600 x 300 x 420
YUDTO18	1800 x 300 x 420

Wood Finish Options



Colorado storage guide

- Pedestals 328
- Filing & Accessories 330
- Cupboards 329-331
- Combi Storage 331
- Desk Extensions 321

- 328
- 330
- 329-331
- 331
- 321



10 Year
Warranty



Supplied empty

Single door cupboards

- Available in LH or RH (RH illustrated)

Code	Dimensions W x D x H
YUSD04-6-7	420 x 600 x 727
YUSD04-5-7	420 x 528 x 727
YUSD04-5-12	420 x 528 x 1207
YUSD04-5-16	420 x 528 x 1607
YUSD04-5-20	420 x 528 x 2007



Supplied empty

Double door cupboards

Code	Dimensions W x D x H
YUSD08-6-7	800 x 600 x 727
YUSD08-E8-7*	800 x 800 x 727
YUSD09-5-7	960 x 528 x 727
YUSD09-E6-7*	960 x 600 x 727
YUSD09-5-12	960 x 528 x 1207
YUSD09-5-16	960 x 528 x 1607
YUSD09-5-20	960 x 528 x 2007

* Extended top

Colorado Storage



Open storage cupboards

- Supplied empty

Code	Dimensions W x D x H
YUSU04-6-7	420 x 600 x 727
YUSU04-5-7	420 x 528 x 727
YUSU04-5-12	420 x 528 x 1207
YUSU04-5-16	420 x 528 x 1607
YUSU04-5-20	420 x 528 x 2007
YUSU08-6-7	800 x 600 x 727
YUSU08-E8-7*	800 x 800 x 727
YUSU09-5-7	960 x 528 x 727
YUSU09-E6-7*	960 x 600 x 727
YUSU09-5-12	960 x 528 x 1207
YUSU09-5-16	960 x 528 x 1607
YUSU09-6-20	960 x 528 x 2007

* Extended top



Supplied empty

Storage cupboards

- Vertical opening tambour

Code	Dimensions W x D x H
YUSVT08-6-7	800 x 600 x 727
YUSVT08-E8-7*	800 x 800 x 727
YUSVT09-5-7	960 x 528 x 727
YUSVT09-E6-7*	960 x 600 x 1207
YUSVT09-5-12	960 x 528 x 1207
YUSVT09-5-16	960 x 528 x 1607
YUSVT09-5-20	960 x 528 x 2007

* Extended top



Storage cupboards

- Side opening tambour

Code	Dimensions W x D x H
YUSOT11-5-7	1120 x 528 x 727
YUSOT11-E6-7*	1120 x 600 x 727
YUSOT11-5-12	1120 x 528 x 1207
YUSOT11-5-16	1120 x 528 x 1607
YUSOT11-5-20	1120 x 528 x 2007

* Extended top



Price does not include pedestal

Pedestal file organiser

Code	Dimensions W x D x H
YUDHP6FO	420 x 600 x 387
YUDHP8FO	420 x 800 x 387

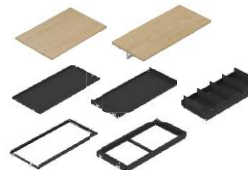

Storage cupboard internals

Code	Dimensions W x D x H
YUS-WS04-6	MFC 420 x 600
YUS-WS04-5	MFC 420 x 528
YUS-WS08	MFC 800 x 600
YUS-WS09	MFC 960 x 528
YUS-WS09-CR	With Coat Rail
YUS-FSS	Steel
YUS-SSH	Slotted Shelf with 5 Dividers
YUS-POF	Pull-Out Filing Frame
YUS-LF	Lateral Filing Frame
YUS-RS	Pull-Out Reference Shelf



Pen trays

YPENTA	For HD 420mm Wide Peds
YPENTB	For Standard 420mm Wide Peds

Colorado Storage

10 Year
Warranty



Cupboards - open fronted

	Shelves (Adjustable)	Dimensions W x D x H
YUDCU06	1	600 x 400 x 727
YUDCU08	1	800 x 400 x 727



Cupboards - open fronted

- UDC3WU12 Low shelf height (from base) 335 x 400mm
- Upper shelf height (from lower shelf) is 314 x 400mm

	Shelves (Adjustable)	Dimensions W x D x H
YUDC3WU12	3	1200 x 400 x 727
YUDC3WU16	3	1600 x 400 x 727



Cupboard - double door

	Shelves (Adjustable)	Dimensions W x D x H
YUDCDD06	1	600 x 400 x 727
YUDCDD08	1	800 x 400 x 727



Credenza units

	Dimensions W x D x H
YUCU-S	3 Shelving Compartments 1600 x 600 x 727
YUCU-F	With Fridge Compartment 1600 x 600 x 727



Combi-stor units

- Single door available in LH or RH (RH shown)
- Shelves included in price

	Shelves (Adjustable)	Dimensions W x D x H
YUCSD04-7-D7	1	400 x 400 x 727
YUCSD04-8-D8	1	400 x 400 x 887
YUCSD04-12-D12	2	400 x 400 x 1287
YUCSD04-16-D16	4	400 x 400 x 1687
YUCSD04-20-D20	5	400 x 400 x 2087



Combi-stor units

- Full double door
- Shelves included in price

	Shelves (Adjustable)	Dimensions W x D x H
YUCSD08-7	1	800 x 400 x 727
YUCSD08-8	2	800 x 400 x 887
YUCSD08-12	3	800 x 400 x 1287
YUCSD08-16	4	800 x 400 x 1687
YUCSD08-20	4	800 x 400 x 2087



Shelves
included in
price

Combi-stor units

- Low double door

	Shelves (Adjustable)	Dimensions W x D x H
YUCSD08-12-D7	2	800 x 400 x 1287
YUCSD08-16-D7	3	800 x 400 x 1687
YUCSD08-20-D7	4	800 x 400 x 2087



Shelves
included in
price

Combi-stor units

- Mid double door

	Shelves (Adjustable)	Dimensions W x D x H
YUCSD08-16-D8	3	800 x 400 x 1687
YUCSD08-20-D8	4	800 x 400 x 2087
YUCSD08-16-D12	3	800 x 400 x 1687
YUCSD08-20-D12	4	800 x 400 x 2087



Shelves
included in
price

Combi-stor units

- Open fronted

	Shelves (Adjustable)	Dimensions W x D x H
YUCSU04-7	1	400 x 400 x 727
YUCSU04-8	1	400 x 400 x 887
YUCSU04-12	2	400 x 400 x 1287
YUCSU04-16	3	400 x 400 x 1687
YUCSU04-20	4	400 x 400 x 2087
YUCSU08-7	1	800 x 400 x 727
YUCSU08-8	1	800 x 400 x 887
YUCSU08-12	2	800 x 400 x 1287
YUCSU08-16	3	800 x 400 x 1687
YUCSU08-20	4	800 x 400 x 2087

10 Year
Warranty



Mattress not supplied, POA

A. Single bedsteads

- Panel frame
- Size W1970 x H525mm

		Depth mm
Y765100*	Small	830
Y765101**	Standard	980

* For a mattress 1900 x 750mm
** For a mattress 1900 x 900mm

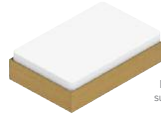

Mattress not supplied, POA

B. Double bedstead

- Panel frame
- Size W1970 x H525mm

		Depth mm
Y765102*	Small	1280
Y765103**	Standard	1430

* For a mattress 1900 x 1200mm
** For a mattress 1900 x 1350mm



Mattress not supplied, POA

C. Welded frame bed

- Single
- Size W1970 x H525mm

		Depth mm
Y765104*	Small	830
Y765105**	Standard	980

* For a mattress 1900 x 750mm
** For a mattress 1900 x 900mm



Mattress not supplied, POA

D. Cabin bed - low unit

- 2 drawer units reqd (see below)
- Size W1970 x H403mm
- See items E & F for storage

		Depth mm
Y765106*	Small	830
Y765107**	Standard	980

* For a mattress 1900 x 750mm
** For a mattress 1900 x 900mm



E. Drawer units (for item D)

- 1 drawer

Y765108	Fits Y765106
---------	--------------



F. Cabin bed - mid unit

- Size W1970 x H606mm
- See items H,I & J for storage

		Depth mm
Y765110*	Small	830
Y765111**	Standard	980

* For a mattress 1900 x 750mm
** For a mattress 1900 x 900mm



Available in LH or RH

G. Single under bed storage

- Single door unit
- Size W480 x H630mm

	Depth mm
Y765120	620



H. Double under bed storage

- Double door unit
- Size W960 x H620mm

	Depth mm
Y765122	620



I. Drawer under bed unit - slim

- 2 drawer unit
- Size W480 x H620mm

	Depth mm
Y765126	620



J. Drawer under bed unit - Wide

- 2 drawer unit
- Size W960 x D620mm

	Depth mm	Width
Y765124	790	

Colorado Residential

The Colorado Residential range of furniture is perfect for student accommodation in colleges and universities. Designed for endurance, we like to call this heavy duty furniture. With a 10 year guarantee, you will be hard pressed to find a more cost-effective long term solution.

Whilst the below items are technically 'off-the-shelf' items, for larger projects that are often led by architects plans, our in-house design team can work closely with you to create a solution that compliments their design whilst advising on what is suitable for the environment the furniture is being used in.

A range of matching top boxes, coat hooks, tables and wall protectors are available - please ask for details.

Wood Finish Options



10 Year Warranty



Shelf not supplied

A. Single wardrobe

- Clothes rail (& fittings) incl.
- Size D600 x H1830mm
- Available in LH or RH

	Width mm
Y765140	400
Y765141	500
Y765142	600



Shelf not supplied

B. Wardrobe & 2 drawers

- Clothes rail (& fittings) incl.
- Size D600 x H1830mm
- Available in LH or RH

	Width mm
Y765143	400
Y765144	500
Y765145	600



Shelf not supplied

C. Double wardrobe

- Clothes rail (& fittings) incl.
- Size D600 x H1830mm

	Width mm
Y765146	800
Y765147	900
Y765148	1000



Shelf not supplied

D. Double wardrobe +drawers

- Clothes rail (& fittings) incl.
- Size D600 x H1830mm
- Lockable option available POA

	Width mm
Y765149	800
Y765150	900
Y765151	1000



E. Wardrobe shelves

	W x Dmm
Y765160	400 x 600
Y765161	500 x 600
Y765162	600 x 600
Y765163	800 x 600
Y765164	900 x 600
Y765165	1000 x 600



F. Wardrobe fitment

- 5 shelves to fit double wardrobe
- Clothes rail (& fittings) incl.

Y765166	To Fit Y765146
Y765167	To Fit Y765147
Y765168	To Fit Y765147



G. Wardrobe fitment

- 4 shelves, to fit double wardrobe with drawers
- Clothes rail (& fittings) incl.

Y765169	To Fit Y765149
Y765170	To Fit Y765150
Y765171	To Fit Y765151

10 Year
Warranty



A. Chest of (3) drawers

- 3 drawers

	W	D	H mm
Y765175	600	470	727
Y765176	800	470	727
Y765177	600	600	727
Y765178	800	600	727



B. Chest of (4) drawers

- 4 drawers

	W	D	H mm
Y765179	600	470	927
Y765180	800	470	927
Y765181	600	600	927
Y765182	800	600	927



C. 2 drawer cabinet

- 2 drawer

	W	D	H mm
Y765183	420	470	727



D. 3 drawer cabinet

- 3 drawer

	W	D	H mm
Y765184	420	470	727



Available in
LH or RH

E. Single door cabinet

- Single drawer

	W	D	H mm
Y765185	420	470	727



Available in
LH or RH

F. Cabinet with drawer & door

- 1 drawer and door

	W	D	H mm
Y765186	420	470	727

Colorado Residential

A range of matching top boxes, coat hooks, tables and wall protectors are available. Please ask for details.

10 Year
Warranty

Wood Finish Options

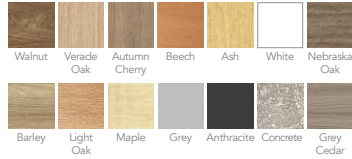

A. Pole leg pedestal desk

- 3 drawer
- Desks are unhandled

	W	D	H mm
Y765190	1000	600	727
Y765191	1200	600	727



B. Panel end pedestal desk

- 3 drawer
- Desks are unhandled

	W	D	H mm
Y765192	1000	600	727
Y765193	1200	600	727



C. Bookshelves

- Wall Hanging

	W	D	H mm
Y765194	600	320	700
Y765195	800	320	700
Y765196	1000	320	700



D. Bookcase 1 shelf

- 1 shelf

	W	D	H mm
Y765197	600	470	727
Y765198	800	470	727



E. Bookcase 2 shelves

- 2 shelves

	W	D	H mm
Y765199	600	470	927
Y765200	800	470	927



F. Bookcase 2 shelves, tall

- 2 shelves

	W	D	H mm
Y765201	600	470	1127
Y765202	800	470	1127



7 Year
Warranty

Best
Seller

Phone
For Bulk
Prices

Orbit Panel Leg Desks
All desks are 725mm high
*Please specify colour when ordering



A. Rectangular workstations

YSR6*	L600 x D800mm
YSR8*	L800 x D800mm
YSR10*	L1000 x D800mm
YSR12*	L1200 x D800mm
YSR14*	L1400 x D800mm
YSR16*	L1600 x D800mm
YSR18*	L1800 x D800mm

Please specify wood finish. Colours shown may not be representative of actual colours - please ask for a sample

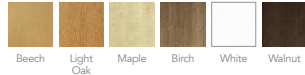

Page Link - see pages

Monitor
arms & CPU
holders



B. Crescent desks right hand

- W1200 x D800mm

YSRH14*	L1400mm
YSRH16*	L1600mm
YSRH18*	L1800mm



C. Crescent desks left hand

- W1200 x D800mm

YSLH14*	L1400mm
YSLH16*	L1600mm
YSLH18*	L1800mm



D. Wave desks right hand

- Depth 1000mm

YSWRH12*	L1200mm
YSWRH14*	L1400mm
YSWRH16*	L1600mm



E. Wave desks left hand

- Depth 1000mm

YSWLH12*	L1200mm
YSWLH14*	L1400mm
YSWLH16*	L1600mm



F. Pedestals

- H725 x W443mm

YSDHP36	D600mm	3 Drawer	- Desk High
YSDHP46	D600mm	4 Drawer	- Desk High
YSDHP38	D800mm	3 Drawer	- Desk High
YSDHP48	D800mm	4 Drawer	- Desk High
YSMP3	Under Desk Pedestal		
	L430 x D600 x H665mm	Drawer	



G. Mobile pedestals

- H542 x W400 x D600mm

YSM62D*	2 Drawer
YSM63D*	3 Drawer



H. Desk high pedestals

- H725 x W400mm

YS63D*	600mm deep 3 Drawer
YS64D*	600mm deep 4 Drawer
YS83D*	800mm deep 3 Drawer
YS84D*	800mm deep 4 Drawer

Orbit Storage

- The Orbit Storage range is extremely flexible and versatile
- The undoubted quality of this storage range allows for a seven year guarantee on all products
- The slim-line 330mm depth of the adjustable shelved units also provides efficient space utilisation within the office or classroom
- All units are 800mm wide
- All units are constructed with 25mm tops and 18mm sides & back panels
- Please specify wood finish
- Finishes include Maple, Beech, Lt Oak, Birch, White & Walnut
- Add doors in a contrasting wood finish to achieve that extra individuality

7 Year
Warranty



Desk high unit

- 725mm high x 350mm deep



Y41558*



Y41562*



Y41566*



Y41570*

2 shelf unit - 1309mm high



Y41578*



Y41590*



Y41582*

3 shelf unit - 1725mm high



Y41598*



Y41606*



Y41614*



Y41602*



Y41738*



Y41622*

4 shelf unit 2141mm high



Y41634*



Y41638*



Y41658*



Y41686*



Y41682*



Y41646*



Y41794*



Y41822*



Y41666*



Y41810*



Signature Storage

Our new Signature storage range offers you a wide selection of stylish Bookcases, Cupboards, Filing Cabinets, Credenza Units and Tambours in a choice of sizes and colour finishes.

It features a contemporary panel base and matching feet, which come in either Silver or White.



Bookcases

Height	Code	800mm Wide	Code
740mm	Y701760	£222.00	Y701770
1000mm	Y701761	£260.00	Y701771
1200mm	Y701762	£316.00	Y701772
1600mm	Y701763	£399.00	Y701773
1800mm	Y701764	£452.00	Y701774
2000mm	Y701765	£485.00	Y701775

All bookcases are supplied with shelves

Credenza units

Height	Code	800mm Wide	Code	1000mm Wide
740mm	Y701780		Y701785	
1000mm	Y701781		Y701786	
1200mm	Y701782		Y701787	

Filing cabinets

Height	
Y701790	2 Drawer 740mm
Y701791	3 Drawer 1070mm
Y701792	4 Drawer 1400mm

Side filer

Height	
Y701795	2 Drawer 740mm



Cupboards

Height	Code	800mm Wide	Code	1000mm Wide
740mm	Y701800		Y701810	
1000mm	Y701801		Y701811	
1200mm	Y701802		Y701812	
1600mm	Y701803		Y701813	
1800mm	Y701804		Y701814	
2000mm	Y701805		Y701815	

Shelves to be purchased separately.

Shelves 800mm wide

Y701840	Single Shelf for Cupboards & Credenza
Y701841	Single Shelf for Tambours
Y701842	Single Filing Frame for Cupboards
Y701843	Single Filing Frame for Tambours
Y701844	Lateral Filing Frame for Cupboards
Y701845	Lateral Filing Frame for Tambours

Shelves 1000mm wide

Y701850	Single Shelf for Cupboards & Credenza
Y701851	Single Shelf for Tambours
Y701852	Single Filing Frame for Cupboards
Y701853	Single Filing Frame for Tambours
Y701854	Lateral Filing Frame for Cupboards
Y701855	Lateral Filing Frame for Tambours

Shelving, Sliding Filing Frames and Lateral Filing Frames are available in Silver or White to complement the stylish panel base and feet.

Tambour Cupboards

Height	Code	800mm Wide	Code	1000mm Wide
740mm	Y701820		Y701830	
1000mm	Y701821		Y701831	
1200mm	Y701822		Y701832	
1600mm	Y701823		Y701833	
1800mm	Y701824		Y701834	
2000mm	Y701825		Y701835	

Shelves to be purchased separately.

Frame & Feet Options



Silver White

Wood Finishes

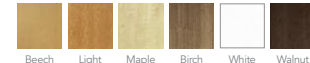

Beech Light Oak Maple Birch White Walnut

Colours shown may not be representative of actual colours - please ask for a sample

Orbit Boardroom Barrel Top Tables



Orbit boardroom barrel top tables

- Premium stylish conference tables available with wooden or metal modesty panel
- Panel end frame
- 25mm tops and legs
- Beech finish as standard

		Std Panel	Metal Panel
YSTB18	W1200 x L1800mm		
YSTB24	W1200 x L2400mm		

Page Link - see pages

Matching office desking

336



Wood & colour finishes may not be representative of actual colours - please ask for a sample

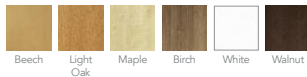

Please specify wood finish when ordering

Orbit Tilt Top Tables



Orbit tilt top tables

Ideal for Meeting Rooms or Classrooms



- Selection of 6 wood finishes
- Lockable castors
- Tubular steel polished chrome finish metalwork
- Linking mechanism available on request
- Can be nested together to save space when folded
- Available in 2 sizes of trapezoidal shape. use 3 x 30° or 4 x 22.5° to make a horseshoe
- All 720mm high

Y15045	1600 x 800mm	Rectangular
Y15047	1800 x 800mm	Rectangular
Y15049	1412 x 740mm	Trapezoidal 22.5°
Y15051	1600 x 693mm	Trapezoidal 30°
Y15053	1600 x 800mm	Semi-Circular



Wood & colour finishes may not be representative of actual colours - please ask for a sample

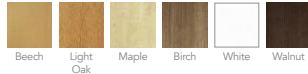

Please specify wood finish when ordering



Polished Chrome Frames

Matches other Orbit products on page 338

Orbit Height Adjustable & Sit-Stand Desks



7 Year
Warranty



Metal Finishes



Silver White

Wood Finishes



Beech Light Oak Maple Birch White Walnut

A. Sit-stand electric rectangular desk

- Provide a flexible solution for the modern office
- An electric motor enables the operator to quickly and easily adjust their posture from a seated position to a standing height for maximum comfort throughout the day
- Full height adjustment from 650mm to 1250mm
- 2 Year Guarantee on the mechanism
- Wave desk style available - please enquire
- Modesty panel available as extra - please enquire

Y700558 1200 x 800mm

Y700560 1400 x 800mm

Y700562 1600 x 800mm

Y700564 1800 x 800mm

B. Height adjustable rectangular desk

- Height adjustable workstations are becoming more popular due to increasing public awareness of the potential health implications associated with being seated for long periods of time
- Full height adjustment from 695mm up to 995mm using side crank handle
- 2 Year Guarantee on mechanism

Y700566 1200 x 800mm

Y700568 1400 x 800mm

Y700570 1600 x 800mm

Y700572 1800 x 800mm

Vermont Height Adjustable Desking

Rectangle height adjustable desk (electric)

With a range of options and height settings, our height adjustable workstations give you the opportunity to create an office space that showcases your style whilst meeting your DDA requirements.

- 25mm Tops
- Adjustment range 710mm – 1210mm
- White or Silver Frames
- Black frames available on request
- 5 year Guarantee

Want to re-use an existing top? All items can be purchased 'frame only' – Please call for prices.

White Frame

Y700350	1200 x 800mm
Y700352	1400 x 800mm
Y700354	1600 x 800mm
Y700356	1800 x 800mm

Silver Frame

Y700358	1200 x 800mm
Y700360	1400 x 800mm
Y700362	1600 x 800mm
Y700364	1800 x 800mm



5 Year
Warranty

Corner height adjustable desk

The Vermont Corner height adjustable desk has all of the advantages of the popular Vermont rectangular desk, with a smooth-operating triple motor system and overload protection as standard. Perfect for executive use, giving extra workspace for printers and storage.

- Black frames available on request

White Frame

Y700366	1600 x 1600mm
Y700368	1800 x 1600mm

Silver Frame

Y700370	1600 x 1600mm
Y700372	1800 x 1600mm

Please state Left or Right Hand at point of ordering.



Finishes

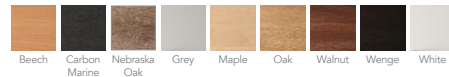

Galway

A bold and characterful tabling system for modern, vibrant working environments. With its chunky steel underframe, these tables and benches carry serious presence! These can be used with soft seating or conference chairs.



- 36mm Tops
- 740mm high
- Lacquered finish
- 'A' profile leg frame available in black only
- 5 year warranty
- Also available with 40mm Solid Oak tops as a special order
- Coloured frame options available – ask for details.

Rectangular Meeting Tables		Top
Y660201	1800 x 900mm	MFC
Y660203	2000 x 1000mm	MFC

Rectangular Meeting Benches		Top
Y660205	1800 x 300mm	MFC
Y660207	2000 x 300mm	MFC

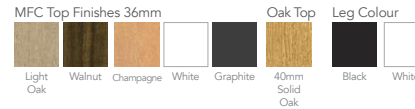

Wexford meeting tables

A clean, straight line and simple design make the Wexford a very desirable table. Supplied in a range of eleven finishes. It's triangular steel leg profile creates an alluring aura of class and is available in a choice of three colours giving scope to enhance any meeting room.

- 25mm top
- 740mm high
- Available with optional power and data fittings
- 5 year warranty
- Black or White frames supplied as standard, Chrome frames available POA

Wexford Square Meeting Tables	
Y660300	1200 x 1200
Y660302	1600 x 1600

Wexford Rectangular Meeting Tables	
Y660312	2000 x 1000

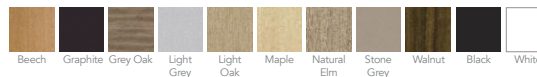

Page Link - see page
For soft seating... 196-201



Pigeon Hole Units

High Quality, long lasting construction. These units are solid and heavy but we have designed them as modular parts which simply connect together with the supplied fixings. Ideal for sorting post & distributing mail.

- Manufactured from quality 18mm laminate
- All shelves are fully adjustable with 32mm hole spacings
- The clear acrylic shelves come complete with a label holder for the front
- Our pigeonhole range is available in a choice of 5 Wood finishes. BEECH, MAPLE, LIGHT OAK, GREY and WHITE
- Other pigeon hole combinations available, please call for details

A. 36 pigeon hole storage with cupboard

- Size: W826 x H1930 x D375mm

Y701101 36 Hole Unit

B. 48 pigeon hole storage with cupboard

- Size: W1094 x H1930 x D375mm

Y701102 48 Hole Unit

C. 72 pigeon hole storage

- Size: W1094 x H1930 x D375mm

Y701103 72 Hole Unit



D. Colorado pigeon hole units

		Dimensions W x D x H (mm)
YUPHU08-7	12 Holes	800 x 360 x 727
YUPHU09-7	12 Holes	960 x 360 x 727
YUPHU09-12	21 Holes	960 x 360 x 1207
YUPHU09-15	27 Holes	960 x 360 x 1607
YUPHU09-18	33 Holes	960 x 360 x 1837
YUPHU-WS08	Extra Shelf	800 x 360
YUPHU-WS09	Extra Shelf	960 x 360

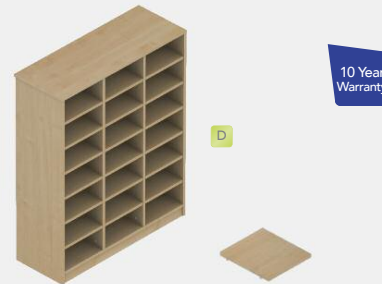

Wood Finish Options

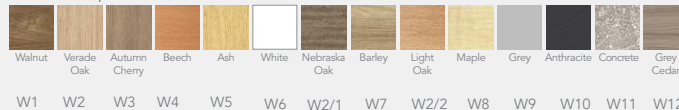



Curved Top & Floor Standing Screens



Straight Top



Wave Top

Colour Options Please ask for Cara or Lucia Fabric Swatch



Freestanding Screen Feet



Table Top Clamp

Screens

- Freestanding screens with feet, desk mountable screens, clip on screens in a variety of heights, fabrics and colours to suit your needs
- We can also supply screens made to any specific size or shape, with different features such as glazed tops, aluminium side trims, stabilising disc feet
- Available with PVC or fabric trim, free-standing
- Talk to us and we'll find the right solution for your needs
- Less than 2 screens may require a carriage charge, please check at time of ordering

A. Nimbus floor standing screens

- Free-standing screens come with two feet and can be fitted with linking strips (this must be specified at the time of order and will incur a small extra charge)
- The screen has a fabric trim as standard but can be supplied with grey or wood effect PVC trim at a small extra charge
- Available as standard or linked screens

Size(mm)	Standard		Linked	
	Code	Price	Code	Price
w1200 x h1200	YFS1212		YLS1212	
w1000 x h1500	YFS1015		YLS1015	
w1200 x h1500	YFS1215		YLS1215	
w1500 x h1500	YFS1515		YLS1515	
w1600 x h1500	YFS1615		YLS1615	
w1200 x h1800	YFS1218		YLS1218	
w1600 x h1800	YFS1618		YLS1618	

For wave top add WW to code

POA

B. Nimbus desk mounted screens

- Clamp-on version

Wave

YWDT1200	W1200 x H280-480mm
YWDT1400	W1400 x H280-480mm
YWDT1600	W1600 x H280-480mm
YWDT1800	W1800 x H280-480mm

Straight

YSDT1200	W1200 x H480mm
YSDT1400	W1400 x H480mm
YSDT1600	W1600 x H480mm
YSDT1800	W1800 x H480mm

Curved

YCDT1200	W1200 x H180-380mm
YCDT1400	W1400 x H180-380mm
YCDT1600	W1600 x H180-380mm
YCDT1800	W1800 x H180-380mm

Fabric Screens

A. Aluminium end posts, plastic top caps

Size	Group 1 Fabrics Code	Group 2 Fabrics Code
W1200 x H380	700400	700430
W1400 x H380	700401	700431
W1600 x H380	700402	700432
W1800 x H380	700403	700433



A

B. Aluminium frame, single tool rail

- Not suitable for monitor mount

Size	Group 1 Fabrics Code	Group 2 Fabrics Code
W1200 x H380	700410	700440
W1400 x H380	700411	700441
W1600 x H380	700412	700442
W1800 x H380	700413	700443



C

C. Aluminium frame, triple tool rail

Size	Group 1 Fabrics Code	Group 2 Fabrics Code
W1200 x H380	700420	700450
W1400 x H380	700421	700451
W1600 x H380	700422	700452
W1800 x H380	700423	700453



D

D. Screen hung accessories

A range of accessories suitable for the desk screen tool rails

Y700470	Pencil Pot
Y700471	Name Holder
Y700473	Trinket Pot
Y700474	Letter Tray A3
Y700475	Letter Tray A4
Y700476	Screen Mounted Pole Monitor Arm



A



DTM2P1S

DTM2P2D1S

DTM4P2D1S

Page Link - see page
Additional
cable
management **350**

B

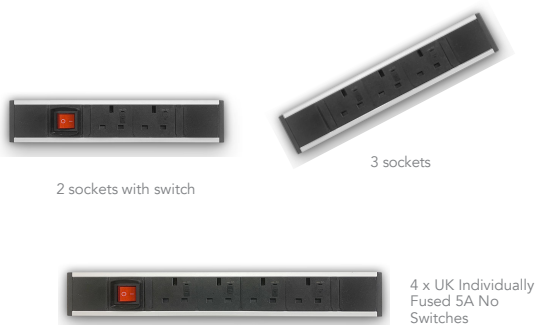

2 sockets with switch

3 sockets

4 x UK Individually Fused 5A No Switches

Cable Management

A. Alpine desk top power modules

- Power and Data where you want it, with added flexibility
- Many choices of configuration of data, power and switches
- Has a spare fuse in every socket
- Can be clamped to the back of the desk in various permutations with the unique fittings on the back of the module (Screen Toolbar mount Also Available)
- Each is supplied with Unique Desk Fittings, 300mm Lead to 3 pole connector and a spare fuse per socket
- Available in White, silver and black

With*
2M Lead

DTM2P1S	2 x UK Sockets 1 x Neon Switch
DTM2P2D1S	2 x UK Sockets 1 x Neon Switch 2 x RJ45 Cat5e Data
DTM4P2D1S	4 x UK Sockets 1 x Neon Switch 1 x USB-A and 1x USB-C

* Other Lead Lengths Available
Many further options available, please call for details

B. Alpine underdesk power modules

- Unique Design with a spare fuse for each socket so minimum downtime if a fuse fails
- Can be fixed underneath the desk
- Each Module may be linked directly to another – including data housings- to achieve the most complex of requirements quickly, easily and cost effectively
- Various Combinations
- Various Lengths of mains, connector and data leads available (see page opposite)

UPM205E	2 x UK Individually Fused 5A No Switches. 250mm Earth Lead
UPM255E	2 x UK Individually Fused 5A 2 Switches. 250mm Earth Lead
UPM303E	3 x UK Individually Fused 3.15A No Switches. 250mm Earth Lead
UPM405E	4 x UK Individually Fused 5A No Switches. 250mm Earth Lead
UPM415E	4 x UK Individually Fused 5A 1 Switches. 250mm Earth Lead
UPM445E	4 x UK Individually Fused 5A 4 Switches. 250mm Earth Lead

Cable Management

A. Mains leads

- Ordered separately for Underdesk Power Modules

ML2	2M UK Plug To 3 Pole Connector
ML3	3M UK Plug To 3 Pole Connector
ML5	5M UK Plug To 3 Pole Connector

Other Lead Lengths Available-please call for details



A

B. Connector leads

- Must be ordered separately for Underdesk Power Modules if connecting to other modules

CON1M	1M 3 Pole Male to Female
CON2M	2M 3 Pole Male to Female Connector

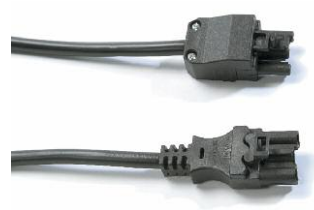

B

C. Cat5e booted data leads

- Must be ordered separately for Underdesk Data Housings

DL2	2M RJ45 Cat5E Data Lead
DL4	4M RJ45 Cat5E Data Lead
DL5	5M RJ45 Cat5E Data Lead
DL10	10M RJ45 Cat5E Data Lead

Other lead lengths available-please call for details



C

D. Power desk inserts

- These power modules sit nicely to a standard 80mm grommet hole allowing the user convenient access to a combination of power, data and smart charge USB
- Ideal for charging phones and tablets
- Available in Silver/White, Silver/Grey, Silver/Black
- Other socket combinations available, POA

Y700520	80mm 1 Power, 1 USB Chrg 2m
Y700521	80mm 1 Power, 1 USB Chrg 3m
Y700522	80mm 1 Power, 1 USB Chrg 5m



1 Power &
1 USB

D



A

Available in twin & quad arms

Quick release height adjustment

Quick release VESA Mounting Plate Feature

Cable Management

A. Roma monitor arms

- Removable VESA mounting plate
- Quick release height adjustment
- Complete cable management
- Includes clamp and through desk fixing
- Available in black, silver and white

PMA521	Pole Mounted Monitor Arm for Single Screen 12.5kg
PMA522	Pole Mounted Monitor Arms for Twin Screens 10kg x 2
PMA524	Pole Mounted Monitor Arms for 4 Screens 8kg x 4
PMSA521	Tool Rail Mounted Pole Monitor Arm for Single Screen 10kg



B

Through desk clamp

Clamp is tightened from above desk

Quick release VESA plate

B. Milano slimline gas lift monitor arms

- Removable VESA mounting plate
- Takes screens from 2kg-9kg
- Complete cable management
- Through desk fixing option
- Available in black, silver and white
- Clamp is tightened from above desk

GMA621	Monitor Arm for Single Screen
--------	-------------------------------

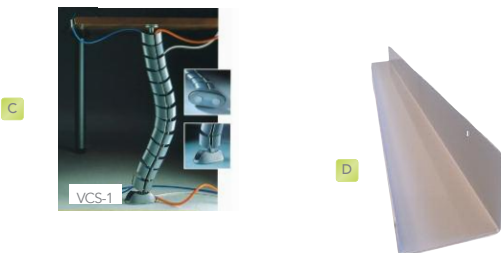

C

VCS-1

D

C. Vertical cable management

VCS-1	Plastic Cable Duct, White or Silver
-------	-------------------------------------

D. Horizontal cable management

- Cable trays:
- Silver metal, attached to modesty panel
 - D70 x H50mm

CTM085	Cable Tray for 1200mm Desk, W850
CTM105	Cable Tray for 1400mm Desk, W1050
CTM125	Cable Tray for 1600mm Desk, W1250
CTM145	Cable Tray for 1800mm Desk, W1450

Cable Management

A. Salerno mini cpu holder

- Ideal for small and thin client CPU's
- Fixes direct to desk top
- Choice of Black, White or Silver

Suitable for Very Small CPUs

	Model	Width Range	Height Range
CHF1104-BK	Black	C4	40-115mm
CHF1104-SV	Silver	C4	40-115mm
CHF1104-WH	White	C4	40-115mm



B. Salerno large cpu holder

- Ideal for older and large CPU's.
- Fixes direct to desk top
- Adjustable width 110 – 230mm; height 300 – 500mm high
- Choice of Black, White or Silver

	Model	Width Range	Height Range
CHF2311-BK	Black	C2	110-230mm
CHF2311-SV	Silver	C2	110-230mm
CHF2311-WH	White	C2	110-230mm
CHF2208-BK	Black	C3	110-230mm
CHF2208-SV	Silver	C3	110-230mm
CHF2208-WH	White	C3	110-230mm



C. Salerno C6 universal strap cpu holder

- Ideal for all sizes of CPU.
- Fixes direct to desk top
- Adjustable width 40 – 230mm; height 180 – 500mm high
- CPU can be mounted vertically or horizontally

CHF2504-BK



Suppose you wanted to create an atmosphere of excellence... Suppose you like impressive classrooms...
Suppose there was a place for everything...

Storagewall is the perfect solution!



Storagewall can be used in a wide variety of applications, shown here in a management area.

Page Link - see pages

Teaching Walls

89-96



Call today for a free site survey and quotation



Storagewall

Full height storage wall in MFC to provide maximum storage in any available area.



Lockers

The provision of personal storage space is a key objective within today's workplace environment.



Alcove modules

Add a seat or a display module with glass doors and low voltage lighting.



Internal fitments

Choose from shelves, filing frames, letter sorters, drawers to suit your own requirements



Tambours

In areas where space is at a premium such as corridors, tambours will overcome access problems.



Media display

Incorporate plasma screens, video-conferencing facilities and other media aids within specialist media modules.

Module options

Designed and manufactured to save space, save money and give you the most flexible and comprehensive storage system available.

There simply isn't sufficient room here to illustrate the huge range of applications and options, please contact your sales representative to arrange an appointment or call us to arrange a showroom visit.



Pigeon hole units

Can be combined with cupboards or drawers to save time and maximise space.



Bespoke colours

A huge range of options available in both woodgrain effects and plain colours, an opportunity to make your storage wall unique.

Internal fitment options



Metal Combi Shelf



Wooden Shelf



Roll-out Filing Frame



Roll-out Storage Drawer



Lateral Filing Frame

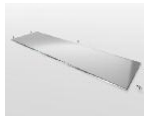

Glass Shelf



Heavy Duty Double Drawer Inside Storage



Pigeon Hole Unit



LED Shelf Lighting



Pull-out Hanging Rail



LED Coat Rail



Static Coat Hanger



Image Ref. 770200

Design options

To further increase the flexibility of the solution available you also have the ability to specify the cupboard functionality using our diverse range of cupboard designs. For space saving and areas such as corridors where access is a key issue utilise the tambour front or sliding doors, for maximum storage the full height doors 'fit the bill', or where something a bit different is needed why not consider wave doors? Variations include split height doors and direct access filing, with the option of glass display alcoves. To increase versatility incorporate lockers and hot desking pedestals for nomadic working practices.

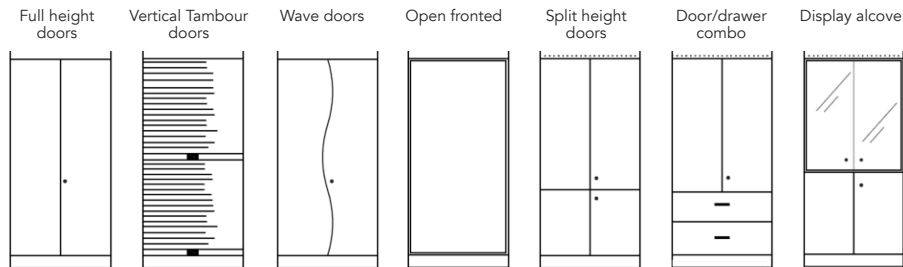

Storagewall

Storagewall can provide up to 60% more storage than conventional storage cupboards – and in the same floor space usage! By using the full height and width of the available area, a storage density of 15.2² metres of storage per metre² of floor space can be achieved.

Consider the ability of storagewall to create an environment that is uncluttered and attractive to work in, functional and efficient to use and is adaptable to the ever changing demands of the modern workplace, and the argument for including it in your interior scheme becomes compelling.

Totally relocatable, able to provide acoustic ratings in line with the best partition systems, and flexible in design – storagewall is a modular storage system that can adapt to any environment.



Storagewall - Internals & Options

Finish options

In order to make your storage wall truly unique and bespoke to your own environment, consider the almost infinite options available to your external finish.

From a wide range of standard MFC finishes and coloured laminates, through book-matched and suited real wood veneers, and to more exotic finishes such as spray lacquered paint finishes, back painted glass and graphics – let the storagewall be the palette for your imagination!



Wood & colour finishes may not be representative of actual colours - please ask for a sample



Laminates



A



Fast Track
5 Year Warranty
Phone For Bulk Prices

Steel Storage

A. Lugano standard filing cabinet



- 30kg suspension file carrying capacity per drawer
- 5 year guarantee
- Anti-tilt locking mechanism
- 100% drawer extension
- Size: W458 x D620mm
- Drawer depth 445mm
- Standard colour Grey
- Ordering less than 2 units may require a carriage charge, please check at time of ordering

YSLV2M*	2 Drawer - 711mm High
YSLV3M*	3 Drawer - 1009mm High
YSLV4M*	4 Drawer - 1320mm High

Discounts available on quantity orders

B



B. Lugano multidrawer units



- Locking and non-locking
- 5 year guarantee
- Smooth running drawers
- Size: W278 x D408mm
- Available in Goose Grey, Coffee Cream, Light Grey and Black
- Ordering less than 2 units may require a carriage charge, please check at time of ordering

		Height mm
YMMR05LK	5 Drawer Locking	355
YMMR10LK	10 Drawer Locking	605
YMMR15LK	15 Drawer Locking	866
YMMR05SD	5 Drawer Non Locking	355
YMMR10SD	10 Drawer Non Locking	605
YMMR15SD	15 Drawer Non Locking	866

* Please state colour required

Steel Storage

A. Lugano premium filing cabinet



- 40kg suspension file carrying capacity per drawer
- 10 year guarantee
- 100% drawer extension
- Size: W458 x D620mm
- Drawer depth 525mm
- Standard colour Grey
- Ordering less than 2 units may require a carriage charge, please check at time of ordering

YMIFC2M*	2 Drawer - 711mm High
YMIFC3M*	3 Drawer - 1009mm High
YMIFC4M*	4 Drawer - 1320mm High

10 Year
Warranty

Phone
For Bulk
Prices



A

B. Hotbox Origin - portable filing cabinet

- Smart, lockable storage makes working anywhere easy
- Combination lock and robust manufacture
- Your lockable storage box is highly portable and easy
- Ideal home office storage solution.
- Perfect for agile workers who work
- Reconfigurable dividers
- Accommodates A4 hanging files
- Storage box with a desk clamp available
- Size: H270mm x W385 x D250mm

Y785000	Hotbox Origin
Y785001	Desk Clamp



B



5 Year
Warranty

A



Steel Storage

A. Lugano storage cupboard



- Two locking doors with strengthener
- 5 year guarantee
- 5 heights available
- 915mm wide x 458mm deep
- Standard colours: Goose Grey, Coffee Cream, Black, Light Grey and Beige. Other colours available to order
- Ordering less than 2 units may require a carriage charge, please check at time of ordering

YMSC1A	690mm High
YMSC4A	1020mm High
YMSC6A	1650mm High
YMSC7A	1830mm High
YMSC8A	1950mm High
YCASP1SD	Plain Shelf, 330mm Hanging

Cupboards supplied empty - choose accessories from range on page 360

15 Year
Warranty

B



B. Lugano executive storage cupboard



- Locking doors with full length reinforcements
- Swan neck handle
- 15 year guarantee
- Security bar option
- 1000mm wide x 507mm deep
- Standard colours: Goose Grey, Coffee Cream, Black, Light Grey and Beige. Other colours available to order
- Ordering less than 2 units may require a carriage charge, please check at time of ordering

Y785020	1020mm High
Y785021	1830mm High
Y785022	1950mm High

Cupboards supplied empty - choose accessories from range on page 360

Standard Colours

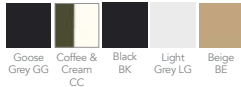

Special Order Colours



Steel Storage

A. Lugano side tambour cupboard



- Magnetic handle strip
- Smooth running track
- 5 year guarantee
- 5 heights available
- Standard colours: Goose Grey, Coffee Cream, Black, Light Grey and Beige. Other colours available to order
- 1003mm wide x 507mm deep
- Ordering less than 2 units may require a carriage charge, please check at time of ordering

YM2ESD	690mm High
YM4ESD	1016mm High
YM9ESD	1320mm High
YM6ESD	1651mm High
YM7ESD	2000mm High
YCAPSP1SD	Plain Shelf, 330mm Hanging

Cupboards supplied empty - choose accessories from range on page 360



5 Year Warranty

A

B. Lugano premium side tambour cupboard



- Smooth track glide system
- 10 year guarantee
- 7 heights available
- 1003mm wide x 507mm deep
- Standard tambour colours: Grey, Black and Beige
- Other tambour colours available to order - Graphite, Silver, Red, Blue and Green - price on application (minimum 10 units)
- Ordering less than 2 units may require a carriage charge, please check at time of ordering

YMXST2	690mm High
YMXST4	1016mm High
YMXST5	1200mm High
YMXST9	1320mm High
YMXST6	1651mm High
YMXST7	2000mm High
YMXST8	2210mm High
YCAPSP1SD	Plain Shelf, 330mm Hanging

Cupboards supplied empty - choose accessories from range on page 360



15 Year Warranty

B

Standard Colours

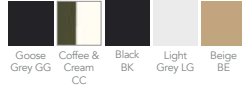

Special Order Colours





Plain Shelf, 330mm hanging



Wardrobe Shelf



Lateral Filing Frame



Roll Out Shelf



Letter Sorter



Roll Out Slotted Drawer / Shelf Dividers



Slotted Shelf / Slotted Shelf Divider



Plain Shelf, 270mm hanging



Roll Out Suspended Filing Frame

Cupboard fittings



With a range of 9 internals, all your storage requirements are covered; and remember all internals can be used in our range of Lugano Side Tambours, Vertical Tambours as well as Open Fronted Cupboards.

- Please note that roll-out items are only recommended in the bottom half of the units
- Remember to specify anti-tilt with roll-out filing

	Lugano & Lugano Premium	Lugano Executive
Plain Shelf 330mm Hanging	YCAPSP1SD	Y785053
Wardrobe Shelf	YCAWSP1	Y785056
Lateral Filing Frame	YCALFP1	Y785050
Roll Out Shelf	YCARSP1SD	Y785054
Letter Sorter	YCALSP1SD	Y785051
Roll Out Slotted Drawer	YCADRP1SD	N/A
Shelf Dividers for above Pk5	Y700150	N/A
Slotted Shelf	YCASSP1SD	Y785055
Shelf Dividers for above PK5	YCASDP5SD	N/A
Plain Shelf 270mm Hanging	YCAPSF1SD	Y785052
Roll out Suspended Filing Frame	YSDCARFP1	Y785057

Teacher Cupboards

- Secure and flexible storage solution for large and small item storage
- Ideal for use in classrooms
- Provides two upper storage levels complete with one adjustable shelf
- Choice of three tray sizes 75, 150 and 225mm high. All trays W312 x D427mm
- Reinforced doors with three point locking
- Tray colour options are opaque, yellow, red and blue
- Supplied with polypropylene trays
- Tray options are 12, 18 & 30 units

Tray storage teacher cupboards

Y785100	12	Extra Deep 225mm	Opaque
Y785200	12	Extra Deep 225mm	Red
Y785300	12	Extra Deep 225mm	Blue
Y785400	12	Extra Deep 225mm	Yellow
Y785500	18	Deep 150mm	Opaque
Y785600	18	Deep 150mm	Red
Y785700	18	Deep 150mm	Blue
Y785800	18	Deep 150mm	Yellow
Y785900	30	Shallow 75mm	Opaque
Y786000	30	Shallow 75mm	Red
Y786100	30	Shallow 75mm	Blue
Y786200	30	Shallow 75mm	Yellow

All cupboards H1830 x W1120 x D457mm. Trays and runners are delivered separately from the cupboard and require fitting on site. Trays manufactured from polypropylene, delivered separately.



Page Link - see pages
Static metal storage
84, 86-88



All cupboards are supplied with a mid grey carcass.

Standard door colours





Designed to contain spillages via the leak proof sump, suitable for those substances classified as being harmful or irritant.
Supplied with GHS labelling, the primary label is 'Exclamation Mark'.

COSHH cabinets

A. COSHH cabinets

Code	Size (h x w x dmm)	Number of Shelves	Sump Capacity	3 Point Locking
YCOH2001	1830 x 1220 x 457	3	45Ltr	
YCOH2002	1830 x 915 x 457	3	36Ltr	
YCOH2003	1220 x 915 x 457	2	36Ltr	
YCOH2004	1830 x 610 x 457	3	20Ltr	
YCOH2005	1000 x 915 x 457	1	30Ltr	
YCOH2006	910 x 457 x 457	1	18Ltr	
YCOH2007	710 x 915 x 457	1	30Ltr	

B. mini COSHH cabinets

Code	Size (h x w x dmm)	Number of Shelves	Sump Capacity	3 Point Locking
YCOH2008	610 x 915 x 381	1	15Ltr	
YCOH2009	760 x 457 x 457	1	10Ltr	
YCOH2010	710 x 457 x 305	1	10Ltr	
YCOH2011	610 x 457 x 457	1	10Ltr	
YCOH2012	457 x 457 x 305	1	5Ltr	

C. COSHH stackable cabinet

Code	Size (h x w x dmm)	Number of Shelves	Sump Capacity	3 Point Locking
YCOH2013	710 x 915 x 457	1	30Ltr	

Dangerous Substance Cabinets

Robust metal construction cabinets with a leak proof sump to contain any spillages. Supplied with GHS labelling, the primary label is 'Flammable'.

A. Dangerous substance cabinets

Code	Size (h x w x dmm)	Number of Shelves	Sump Capacity	3 Point Locking
YDSC1001	1830 x 1220 x 457	3	45Ltr	
YDSC1002	1830 x 915 x 457	3	36Ltr	
YDSC1003	1830 x 610 x 457	3	20Ltr	
YDSC1004	1525 x 915 x 457	2	36Ltr	
YDSC1005	1220 x 915 x 457	2	36Ltr	
YDSC1006	1000 x 915 x 457	1	30Ltr	
YDSC1007	910 x 457 x 457	1	18Ltr	
YDSC1008	710 x 915 x 457	1	30Ltr	



B. Mini dangerous substance cabinets

Code	Size (h x w x dmm)	Number of Shelves	Sump Capacity	3 Point Locking
YDSC1009	610 x 915 x 457	1	30Ltr	
YDSC1010	610 x 915 x 381	1	15Ltr	
YDSC1011	780 x 457 x 457	1	10Ltr	
YDSC1012	710 x 457 x 305	1	10Ltr	
YDSC1013	710 x 355 x 305	1	5Ltr	
YDSC1014	610 x 457 x 457	1	10Ltr	
YDSC1015	457 x 457 x 305	1	5Ltr	



C. Dangerous substance wall cabinets

Code	Size (h x w x dmm)	Number of Shelves	Sump Capacity	3 Point Locking
YDSC1016	610 x 915 x 381	1	15Ltr	
YDSC1017	480 x 915 x 457	1	20Ltr	

D. Dangerous substance stackable cabinets

Code	Size (h x w x dmm)	Number of Shelves	Sump Capacity	3 Point Locking
YDSC1018	710 x 915 x 457	1	30Ltr	
YDSC1019	610 x 915 x 457	1	30Ltr	



FREE Pen Tray and 2 drawer dividers with every pedestal

Steel Storage

Anzio CUBE Steel Pedestals



White Pedestals, Standard and Narrow Widths



3 Drawer, Silver Pedestals, Standard & Low Heights



- Super strong, smart option for the modern office
- Range includes narrow (300mm) width – ideal for small desks
- Choice of white or silver in all sizes
- Free drawer dividers and pen tray with every pedestal
- Available on Express 7 day delivery
- 4 locking, hidden castors (supplied, fitted)
- 5 year guarantee
- Compact 500mm depth – doesn't clash with large cable trays
- Main colour used inside drawers
- Central locking – free master key with large orders
- Anti-tilt mechanism
- Soft close drawer runners



All Anzio CUBE Steel Pedestals Come With Free Drawer Dividers & Pen Tray



A



B



C



D

Page Link - see pages
For wooden pedestals
310,328



A. Steel low mobile pedestal

- 1 Personal drawer 1 File drawer
- 410 x 500 x H495mm

YPMS4511-SV Silver

YPMS4511-WH White

B. Steel narrow low mobile pedestal

- 1 Personal drawer 1 File drawer
- 300 x 500 x H495mm

YPMS3511-SV Silver

YPMS3511-WH White

C. Steel mobile pedestal

- 2 Personal drawers 1 File drawer
- 410 x 500 x H597mm

YPMS4521-SV Silver

YPMS4521-WH White

YPMS4521-AN Anthracite

YPMS4521-BK Black

D. Steel narrow mobile pedestal

- 2 Personal drawers 1 File drawer
- 300 x 500 x H597mm

YPMS3521-SV Silver

YPMS3521-WH White

YPMS3521-AN Anthracite

YPMS3521-BK Black



Desk Organisation

A

A. Hot Box

- Portable desk organisation
- Ideal for agile working
- Promotes a 'clean desk' policy
- LED internal light
- Prepared for fixing to walls or concrete floors. Fixings supplied
- Scratch resistant metallic graphite paint
- Item 780600 stores laptop up to 430mm wide

Code	External size H x W x Dmm
hotbox1	190 x 312x 182

Safes

A. Key deposit safes

- Ideal for schools, office blocks, garages, homes
- Fitted with advanced electronic locking system, including anti-tamper or bounce solenoid locking system, and a key override facility
- Key deposit slot allows keys to be deposited without the need to open the safe
- Prepared for wall mounting, fixing bolts supplied
- Supplied with a selection of coloured key rings

Code	External size H x W x Dmm	Deposit slot H x W x Dmm	Capacity
Y787600	280 x 300 x 100	55 x 35 x 15	30 keys
Y787700	360 x 300 x 100	55 x 35 x 15	48 keys
Y787800	660 x 430 x 130	55 x 35 x 15	144 keys



Key Deposit Slot



787600



787700



787800

B

Lifetime
Warranty



Safes

A. Electronic fire safe

- Modern, compact fire and security safe
- 60 minutes fire protection for paper
- £1,500 cash and £15,000 valuable rating
- Fitted with user friendly, high security electronic lock
- Ultra-lightweight, 5 internal key hooks & pull out drawer
- Ready prepared for floor fixing (bolts supplied).

	Dimensions Size H x W x Dmm	Capacity Litres	Weight Kg
YEFS1A	315 x 430 x 430	20	21
YEFS2A	490 x 350 x 430	28	28
YEFS3A	490 x 430 x 430	30	30
	Underdesk		



B. Security safe

- Fitted with high security double bitted VDS Class 1 key lock
- Fixing bolts supplied
- Manufacturer's insurance rating for cash and jewellery
- Also available with electronic locking, ask for details

	Internal/External Size H x W x Dmm	Capacity Litres	Weight Kg
Y1181	140 x 270 x 200	18	20
	220 x 350 x 300		
Y1182	270 x 370 x 250	28	40
	350 x 450 x 350		
Y1183 (underdesk)	470 x 370 x 250	43	56
	550 x 450 x 350		

Safes

C. Fire resistant cupboards

- High security cupboards with double walled construction
- Perfect for storing sensitive exam papers
- Fire resistant to 30 minutes
- 3 way locking system
- Supplied with height adjustable shelves
- Standard colour grey (RAL7035)
- Internal fittings available at extra cost. Please call for details.
- Electronic keypad locking system

Code	Internal Size h x w x d (mm)	Capacity Litres	Weight Kg
YFRC1	1082 x 506 x 415 3 Shelves Light Grey	230	77
YFRC2	1050 x 814 x 415 4 Shelves Light Grey	359	106
YFRC3	1810 x 814 x 415 4 Shelves Light Grey	615	152



B. Double secure filing cabinets

- Robust filing cabinets with locking bar system giving high security storage at a budget price
- 100% drawer extension
- 10 year guarantee
- Available in Goose Grey or Coffee Cream

Y11325	2 Drawer
Y11326	3 Drawer
Y11327	4 Drawer

C. Fire resistant filing cabinets

- Light grey filing cabinets
- Fire resistant for 90 minutes
- Individual fire protection for all drawers
- Fire and impact tested 9.1metres for resistance to the impact of falling through the burning floors of a building

Y2244	4 Drawer	230kg
Y2242	2 Drawer	140kg

D. Double secure filing cupboard

- Robust filing cupboard with locking bar system giving high security storage at a budget price
- 2 locking doors
- 5 year guarantee
- 915mm wide x 458mm deep
- Standard Colours: Light Grey, Goose Grey, Graphite, Black or Coffee Cream

Y785030	1830mm High
---------	-------------



Janitorial

E. Double secure filing cabinets

- Move heavy items safely
- Items can be moved with one person using the (weight dependent)
- Robust
- British made

EVODOLLY	Moving Skate
EVODOLLYHA	Moving Skate w/handle
EVOHEAVY	Heavy duty non-slip skate







SPACES TAYLORED

Presentation & Display

Whiteboards & Writable Wall	370-373
Glass Boards	374
Mobile Whiteboards	375
Flipchart Easels	376-378
Projection Screens	379
Interactive Flat Panel Display Boards	380
Noticeboards	389
Exterior Showcases	390
Folding Display Systems	391-394
Literature Display	395
Poster Frames	396
Display Showcases	397-398
Lecterns	399
AV Cabinets	400

[Main Content Page](#)

Presentation & Display

Having a display that looks effective and attractive can sometimes be difficult to achieve. Our large range of high quality display products will assist you in presenting your student's work to look its best as well as adding a feature to your classroom or school.

Whether you require just one notice board or a complete display system we can fulfill your requirements to your best advantage. If there is something you are looking for and can't find it in our catalogue please give us a call; we are sure we will be able to source it for you.



BESPOKE WRITABLE, MAGNETIC & PROJECTABLE WALLS

PROMOTE BRAND, ENHANCE CREATIVITY, ENCOURAGE TEAMWORK.

Smarter Surfaces UK turn walls, doors, tables etc into creative work surfaces. It is an incredible product that allows you to write on walls (and other surfaces) just like a whiteboard using Smarter Surfaces award winning smart wall, magnetic and projectable paints. All our paints can also include antimicrobial technology that kills 99.99% of bacteria and is certified to ISO 22196.



PROUD TO OFFER THE FOLLOWING PRODUCTS

Paints

Smart wall paint white/ clear; Super magnetic paint; Magnetic/projectable paint; Blackboard paint; White/ Clear primer.

Wall Coverings

Whiteboard wall covering - gloss/ low sheen finish; Magnetic whiteboard wall covering - gloss/ low sheen finish; Wall covering adhesive

Vinyl/Plaster

Self adhesive whiteboard vinyl - White/ low sheen finish; Disposable whiteboard sheets (20 Sheet roll); Magnetic plaster adhesive

Best Seller

A



B



Premium Quality Brands

C



Premium Quality Brands

Whiteboards

A. Plain & gridded non-magnetic whiteboards

Double sided whiteboard with one side plain ultrasmooth surface and gridded surface on the other. The gridded side has a feint 20mm square grid that assists the presenter, but is unseen by the audience. Aluminium framed & supplied with pen tray and concealed through-the-corner wall fixings. For use with drywipe pens. Mounted landscape or portrait.

YSMDW152	W600 x H450mm
YSMDW32	W600 x H900mm
YSMDW43	W900 x H1200mm
YSMDW44	W1200 x H1200mm
YSMDW54	W1500 x H1200mm
YSMDW64	W1800 x H1200mm
YSMDW84	W2400 x H1200mm
YSMDW94	W2700 x H1200mm

B. Magnetic whiteboards

This economically priced whiteboard has a revolutionary new surface which is ultra smooth to improve erasability, with the added advantage of accepting magnets

- Aluminium framed plain white drywipe surface
- Supplied with concealed wall fixings and pen tray
- All boards 180cm wide and larger have extra central fixings at top and bottom for additional safety and stability

YSMDWM152	W450 x H600mm	each	£18.85
YSMDWM32	W600 x H900mm	each	
YSMDWM43	W900 x H1200mm	each	
YSMDWM44	W1200 x H1200mm	each	
YSMDWM54	W1500 x H1200mm	each	
YSMDWM64	W1800 x H1200mm	each	
YSMDWM84	W2400 x H1200mm	each	
YSMDWM94	W2700 x H1200mm	each	
YSMDWM98	W3000 x H1200mm	each	

C. Vitreous enamel steel magnetic whiteboards

- Vitreous Enamel Steel with 25 year surface guarantee
- Aluminium framed whiteboards with concealed corner fixings and pen tray
- Surface accept magnets
- All boards 180cm wide and larger have extra central fixings at top and bottom for additional safety and stability

YVDW152	W450 x H600mm
YVDW32	W900 x H600mm
YVDW43	W1200 x H900mm
YVDW44	W1200 x H1200mm
YVDW54	W1500 x H1200mm
YVDW64	W1800 x H1200mm
YVDW84	W2400 x H1200mm
YVDW94	W2700 x H1200mm

Whiteboards

A. Coloured edge frameless whiteboards

- The tough ABS colour edging adds a modern accent to an everyday product
- Frameless whiteboard with a coloured edge
- Mounts flush to the wall
- Choice of 6 bright colours with matching caps
- Ideal for mounting side by side
- Please note: these boards are frameless so sizes shown are nominal

Y31060**	W900 x H600mm
Y31062**	W1200 x H900mm
Y31064**	W1200 x H1200mm
Y31066**	W1500 x H1200mm
Y31068**	W1800 x H1200mm
Y31070**	W2400 x H1200mm

**Please specify colour when ordering



B. Light oak effect premium aluminium frame whiteboard

Stunning light oak wood effect aluminium frame with a traditional yet contemporary finish without the maintenance of real wood.

- Coated Steel Surface accepts magnets
- Attractive contoured frame design
- Concealed corner fixings

Y801650	W900 x H600mm
Y801652	W1200 x H900mm
Y801646	W1200 x H1200mm
Y801648	W1500 x H1200mm
Y801654	W1800 x H1200mm
Y801656	W2400 x H1200mm

C. Coloured edge premium aluminium frame whiteboard

- Concealed corner fixings
- Coated steel surface accepts magnets
- Available in 4 different colours

Y801150	W900 x H600mm
Y801152	W1200 x H900mm
Y801154	W1200 x H1200mm
Y801156	W1500 x H1200mm
Y801158	W1800 x H1200mm
Y801160	W2400 x H1200mm

**Please specify colour when ordering



A



B

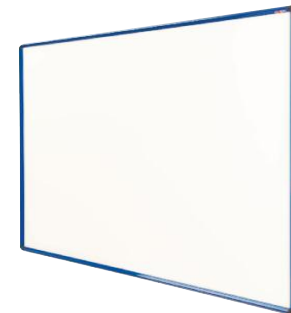

C

A

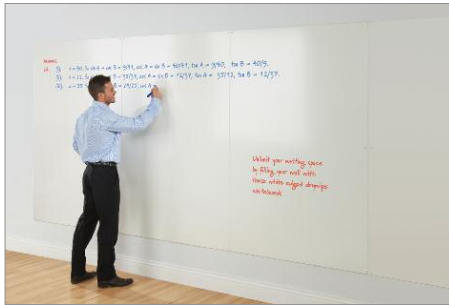

B



Whiteboards

A. Writewall Whiteboard walling

- Create a continuous drywipe whiteboard wall
- Frameless design
- 6 standard sizes to choose from to create the best option
- Simple through the board fixing
- ABS edge, white caps mask fixings
- Double sided, plain on one side, and feint square grid on the other
- Bespoke sizes available - please enquire

Y31072 W876 x H578mm

Y31074 W1176 x H876mm

Y31076 W1176 x H1176mm

Y31078 W1476 x H1176mm

Y31080 W1779 x H1176mm

Y31082 W2379 x H1176mm

Page Link - see pages

For
Conference
Seating  263-276



Page Link - see pages

For
Meeting
Tables  304-307



B. Frameless magnetic board

- Boards butt together to create a seamless, continuous run on flat walls
- Mounts flush to the wall
- Concealed mounting system
- Coated steel surface bonded to multi-layered wood backing

Y802500 W1200 x H1000mm

Y802505 W2400 x H1000mm



Edge detail

Glass Boards

A. Magnetic glass whiteboards

- The ultimate in contemporary drywipe presentation
- Magnetic glass drywipe board
- 4mm toughened safety glass, needs super strength magnets
- Chrome mounts which float the board away from the wall
- All fixings included
- Only available in White

Y31091	W600 x H900mm	
Y31092	W650 x H1000mm	
Y31093	W1500 x H1000mm	
Y31094	W900 x H1200mm	
Y31095	W1200 x H1200mm	
Y31096	W1800 x H1200mm	
Y31097	W2400 x H1200mm	
Y800120	Glass Pen Tray	
Y800122	25mm Super Strength Magnets	pk 2
Y800124	Glass Pens	pk 5



A

B. Coloured glass information boards

- Display your messages or menus in style
- 6 standard colour range, 4 vibrant colour range
- Range of attractive glass dry-wipe boards
- 4.5mm toughened glass with a steel back
- Accepts super strength magnets
- Board stands proud of the wall on special fixings

Y31098**	W500 x H500mm
Y31099**	W450 x H600mm

** Please specify board colour when ordering



B

Standard colours

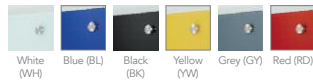

Vibrant colours

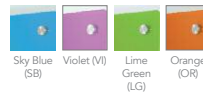

C. Revolving glass whiteboard

Versatile mobile glass whiteboard that rotates and tilts to the desired viewing angle

- Steel core to accept super strength magnets
- White steel frame
- Sturdy feet with locking castors
- Full width steel pen tray

Y801658	W1200 x H900mm
---------	----------------



C

Mobile Whiteboards

A. Height adjustable mobile whiteboards

Double sided mobile drywipe whiteboard

- White anodised aluminium frame with locking castors
- Height adjustable panels that can be mounted portrait or landscape
- Double sided whiteboard with one side plain and the reverse with a feint grid

Y801280	W900 x H1200mm
Y801282	W1200 x H1200mm
Y801284	W1500 x H1200mm
Y801286	W1800 x H1200mm

A



Page Link - see pages

For Meeting Tables 307-346



B



B. Combi mobile noticeboards

- Freestanding board with whiteboard one side, noticeboard on reverse
- A versatile mobile board offering both pinboard and whiteboard applications in one product
- Available in two popular sizes and mounted on a stable powder coated steel frame, with four castors two of which are lockable
- A1 flip pad clamp on all whiteboard surfaces
- W700 x H1200mm available in grey or blue pinboard

DUONB127	W700 x H1200mm, Grey
Y802000	W700 x H1200mm, Blue
DUONB110	W1000 x H1000mm, Grey

Mobile Whiteboards

A. Standard revolving whiteboards

- Double sided whiteboard that can pivot on its horizontal axis
- Enables both sides to be used, or the surface angled towards the audience
- Available with coated steel writing surface that has the advantage of accepting magnets, or non-magnetic surface that is one side plain, one side gridded.
- Sturdy steel frame has four castors, 2 locking
- Steel cross bars aid rigidity and house a full length pen tray

Non Magnetic

YEREV912	W1200 x H900mm	each
YEREV129	W900 x H1200mm	each
YEREV1212	W1200 x H1200mm	each
YEREV1215	W1500 x H1200mm	each
YEREV1218	W1800 x H1200mm	each

Magnetic

YEREM912	W1200 x H900mm	each
YEREM129	W900 x H1200mm	each
YEREM1212	W1200 x H1200mm	each
YEREM1215	W1500 x H1200mm	each
YEREM1218	W1800 x H1200mm	each



A



B. Premium revolving whiteboards

- Versatile mobile whiteboard with dual action pivoting board
- Double sided whiteboard that can pivot on either its horizontal or vertical axis, enabling both sides to be used, or the surface angled towards the audience
- Available with coated steel writing surface that has the advantage of accepting magnets, or non-magnetic surface that is one side plain, one side gridded

Non Magnetic

YREV912	W1200 x H900mm
YREV129	W900 x H1200mm
YREV1212	W1200 x H1200mm
YREV1512	W1500 x H1200mm
YREV1812	W1800 x H1200mm

Magnetic

YREVM912	W1200 x H900mm
YREVM129	W900 x H1200mm
YREVM1212	W1200 x H1200mm
YREVM1512	W1500 x H1200mm
YREVM1812	W1800 x H1200mm

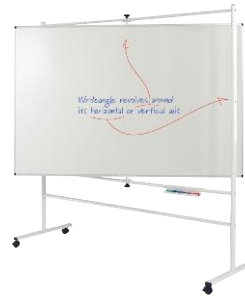

B



A

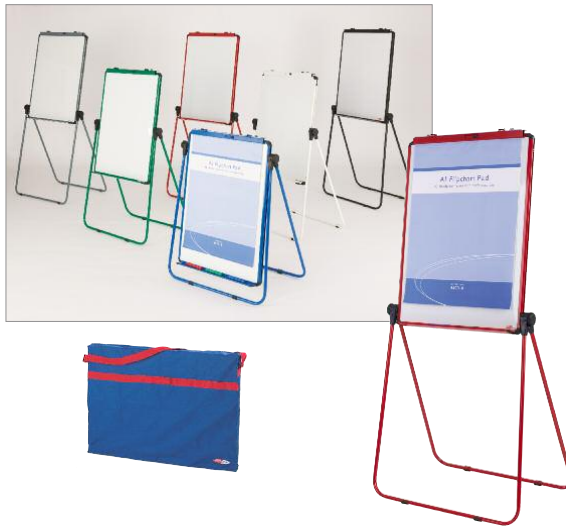

Flipchart Easels

A. Ultimate loopleg flipchart easel (coloured frames)

- Loopleg design creates very steady base with footbar
- Good stability when writing
- Double sized magnetic whiteboard, fully height adjustable
- Suitable for A1 standard 2 hole drilled pads
- Board size W650 x H860mm
- Max height 1720mm
- Optional carry bag

Y31001** Flipchart Easel

Y31067 Optional Carry Bag

** Please specify colour when ordering

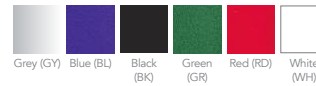

B



** Image shows 2x Mobile Whiteboards

B. Motus mobile whiteboard

- Frame colour available in white, silver or graphite (supplied with a silver link).
- Each screen is supplied with two end trims.
- Screens are linking.
- Straight screens supplied with four silver castor feet, two locking and two non locking as standard.
- Part drywipe & part magnetic drywipe always supplied with mid triple toolrail.
- Screen height includes height of feet.
- Accessories and options available, call for details

MO/18.12PMDA part magnetic dry wipe band A

** Please specify colour when ordering

Flipchart Easels

A. Harrier flipchart easel

Economy tripod easel with class beating features

- Rear leg tie bar for extra stability and durability
- Telescopic legs for simple height adjustment
- Non-magnetic drywipe surface
- Available in Black or White frame
- Board size 1000 x 680mm
- Max height 1850mm

Y800130	Harrier Flipchart Easel - White
Y800132	Harrier Flipchart Easel - Black



A

B. Eagle mobile flipchart easel

Mobile easel mounted on five star base with locking castors

- Magnetic whiteboard
- Height adjustable
- Two side arms supplied as standard for hanging completed sheets
- Full width pen tray
- Board size 1000 x 680mm
- Max height 1820mm

Y800140	Mobile Flipchart Easel Grey
Y800142	Mobile Flipchart Easel Blue

New
Blue
Colour



B

C. A1 flipchart pads

Ideal for easels and mobile flipcharts

- 40 sheets per pad
- Supplied in packs of 5

Y800150	Pack of 5 Pads
---------	----------------



C



Projection Screens

A. Portable projection screen

- Fully height adjustable
- Heavy duty tripod base
- Integral carry handle
- 5 different size viewing areas
- Plain matt white borderless surface or matt white projection surface with black borders
- Built-in 'keystone' correction

Borderless	Overall Size
Y801100	W1250 x H1250mm
Y801110	W1500 x H1500mm
Y801120	W1800 x H1800mm
Y801130	W2000 x H2000mm
Y801140	W2400 x H2400mm

With Borders	Overall Size
Y801105	W1250 x H1250mm
Y801115	W1500 x H1500mm
Y801125	W1800 x H1800mm
Y801135	W2000 x H2000mm
Y801145	W2400 x H2400mm



B. Manual wall-mounted projection screen

- Popular manual pull-down screen
- New slow safety retract mechanism
- Good quality matt white woven cloth
- Easy to mount to wall or ceiling
- Available in 5 different size viewing areas
- Plain matt white borderless surface or matt white projection surface with black borders
- Wider choice of manual and electric projection screens available - please ask for details

Borderless	Overall Size
Y801200	W1250 x H1250mm
Y801210	W1500 x H1500mm
Y801220	W1800 x H1800mm
Y801230	W2000 x H2000mm
Y801240	W2400 x H2400mm

With Borders	Overall Size
Y801215	W1500 x H1500mm
Y801225	W1800 x H1800mm
Y801235	W2000 x H2000mm
Y801245	W2400 x H2400mm



SMART
Board™



Interactive Flat Panel Display Boards

Award-winning interactive displays & lesson delivery software for education

These interactive display boards offer a range of education technology solutions that are built for collaboration, ease of use, and flexibility in a Google technology ecosystem.

All the Essentials, All-In-One, and Value-Focussed

The value-focussed interactive displays are designed to provide teachers with everything they need straight out of the box. Internet-ready and preloaded with a whole range of teaching tools. They are the long-term, reliable solution for schools looking to replace outdated whiteboard systems with an easy-to-use and highly capable interactive display.

- These interactive display boards include classroom essential apps and a variety of teaching tools – all available at the touch of a button
- Use the infinite canvas on the highly intuitive whiteboard app to instantly supplement lessons.
- Draw, highlight, and annotate over any content from any source
- Quickly screen capture content, crop, and open it within the whiteboard app for further discussion
- Add excitement to any lesson or activity with the customisable apps

PLEASE CONTACT US FOR
MORE INFORMATION

FREE DEMONSTRATIONS
AVAILABLE



A

Felt colours:

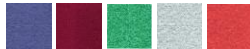

Blue (BL) Burgundy (BG) Green (GR) Grey (GY) Red (RD)



B

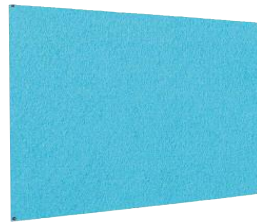

Fabric colours:



Apple Green (AG) Cyan (CY) Magenta (MG) Lilac (LL) Orange (OR) Purple (PR)

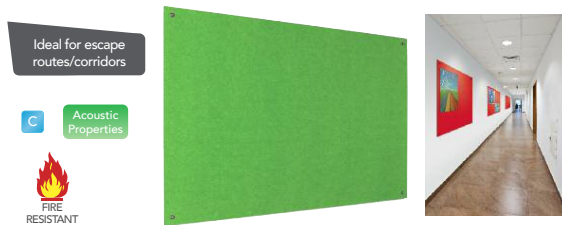

C



Raspberry (RS) Red (RD) Orange (OR) Apple Green (AP) Blue (BL) Purple (PU) Grey (GY) Charcoal (CH) Green (GR) Lt Blue (LB) Natural (NA)

Unframed Noticeboards

A. Unframed noticeboards

This superior frameless pinboard is made from a high quality board and felt to give a durable and effective product.

- Can be mounted landscape or portrait
- Mounts through the board fixings supplied
- Available in Blue (BL), Burgundy (BG), Green (GR), Red (RD), Grey (GY)
- Can be made to a custom size - POA
- 1500 x 1200mm and larger are supplied in 2 parts

YUNB9060**	W900 x H600mm	each
YUNB129**	W1200 x H900mm	each
YUNB1212**	W1200 x H1200mm	each
YUNB1512**	W1500 x H1200mm	each
YUNB1812**	W1800 x H1200mm	each
YUNB2412**	W2400 x H1200mm	each

** Please specify colour when ordering

B. Colourtone vibrant unframed noticeboards

Simple yet effective style noticeboards to brighten up areas of any establishment.

- Can be mounted landscape or portrait
- Frameless design
- Available in 6 vibrant colours
- 3 largest sizes are supplied in 2 parts

Y801900**	W900 x H600mm
Y801904**	W1200 x H900mm
Y801905**	W1200 x H1200mm
Y801907**	W1500 x H1200mm
Y801909**	W1800 x H1200mm
Y801911**	W2400 x H1200mm

** Please specify colour when ordering

C. Unframed EcoColour® noticeboards

A fantastic range of recycled noticeboards that are not only fire resistant but also have acoustic properties. These boards are made from recycled plastic and in the production of the 1200 x 900mm option there are typically 33 x 25g plastic bottles

- Fire Resistant to Class 0
- Noticeboard is classified a 'B' according to BS EN13501-1
- Made from recycled materials
- Acoustic properties up to NRC 0.8
- Self- coloured pinnable core
- Available in 11 different colours

Y801500**	W900 x H600mm
Y801502**	W1200 x H900mm
Y801504**	W1200 x H1200mm
Y801506**	W1500 x H1200mm
Y801508**	W1800 x H1200mm
Y801510**	W2400 x H1200mm

** Please specify colour when ordering

Framed Noticeboards

A. Aluminium framed noticeboards

Made in the UK to the highest standards.

- Felt accepts Velcro® as well as pins - colour fast to BS1006
- Available in 5 standard felt colours - Blue (BL), Burgundy (BG), Red (RD), Green (GR), Grey (GY) or traditional cork
- Flush fix corners conceal wall fixings (supplied)

YNBS64**	W600 x H450mm	each
YNBS96**	W900 x H600mm	each
YNBS129**	W1200 x H900mm	each
YNBS1212**	W1200 x H1200mm	each
YNBS1512**	W1200 x H1500mm	each
YNBS1812**	W1200 x H1800mm	each
YNBS2412**	W1200 x H2400mm	each

** Please specify colour when ordering

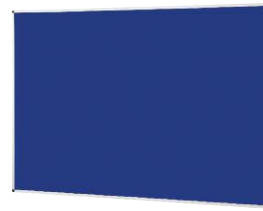

Best Seller

A

Felt colours:



B. Colourtone vibrant noticeboards

- Colourtone range features 6 vibrant and contemporary colours that add a modern accent to an everyday product.
- New range of bright contemporary coloured fabric finishes
- Fabric accepts Velcro as well as pins
- Aluminium frames
- Flush fix corners conceal wall fixings
- 3 smaller size options available - please enquire

Y31000**	W900 x H600mm	
Y31002**	W1200 x H900mm	
Y31005A**	W1200 x H1200mm	
Y31007A**	W1500 x H1200mm	
Y31008**	W1800 x H1200mm	
Y31011A**	W2400 x H1200mm	

** Please specify colour when ordering

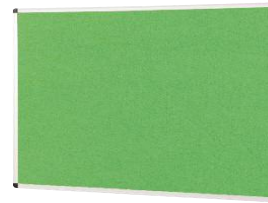

B

Fabric colours:

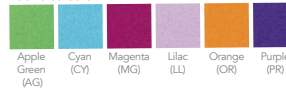

C. Aluminium frame EcoColour® noticeboards

A fantastic range of recycled noticeboards with aluminium frame that are not only fire resistant but also have acoustic properties. These boards are made from recycled plastic and in the production of the 1200 x 900mm option there are typically 33 x 25g plastic bottles

- Fire Resistant to Class 0
- Noticeboard is classified a 'B' according to BS EN13501-1
- Made from recycled materials
- Acoustic properties up to NRC 0.8
- Self- coloured pinnable core
- Available in 11 different colours

Y801520**	W900 x H600mm	
Y801522**	W1200 x H900mm	
Y801524**	W1200 x H1200mm	
Y801526**	W1500 x H1200mm	
Y801528**	W1800 x H1200mm	
Y801530**	W2400 x H1200mm	

** Please specify colour when ordering



Acoustic Properties

C



Ideal for escape routes/corridors



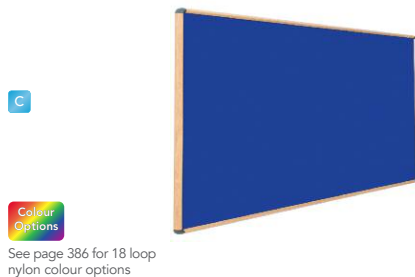

Framed Noticeboards

A. Eco-friendly noticeboards

Ever popular range offering an environmental choice at an economical price and made in the UK

- Almost entirely constructed from timber industry bi-products and recycled materials
- Attractive contoured 35mm wide frame is available in a choice of light oak, mahogany or aluminium effect finishes
- Available in 5 felt colours: Blue (BL), Burgundy (BG), Green (GR), Grey (GY), Red (RD) or Traditional Cork (CK)
- Felt accept both pins and Velcro®, cork option is pinnable
- Boards can be mounted portrait or landscape with concealed fixings provided

YECF96**	W900 x H600mm
YECF129**	W1200 x H900mm
YECF1212**	W1200 x H1200mm
YECF1512**	W1500 x H1200mm
YECF1812**	W1800 x H1200mm
YECF2412**	W2400 x H1200mm

** Please specify colour of material and frame when ordering

B. Light oak effect premium aluminium frame EcoColour® noticeboard

A range of boards made from the EcoColour® recycled material with a stunning light oak effect aluminium frame. Our popular EcoColour® material meets the relevant British Fire Safety Standards, and is fast becoming the preferred choice for fire resistant noticeboards in the UK.

- Can be mounted portrait or landscape
- Acoustic properties up to NRC 0.8
- Self- coloured pinnable core
- Available in 11 different colours
- Noticeboard is classified a 'B' according to BS EN13501-1

Y801560**	W900 x H600mm
Y801562**	W1200 x H900mm
Y801564**	W1200 x H1200mm
Y801566**	W1500 x H1200mm
Y801567**	W1800 x H1200mm
Y801568**	W2400 x H1200mm

** Please specify colour when ordering

C. Light oak effect premium aluminium frame noticeboard

Stunning light oak wood effect aluminium frame with a traditional yet contemporary finish without the maintenance of real wood.

- Attractive contoured frame design
- Available in loop nylon fabric with 17 colour options
- Use with pins or Velcro
- Concealed corner fixings

Y801540**	W900 x H600mm
Y801542**	W1200 x H900mm
Y801544**	W1200 x H1200mm
Y801546**	W1500 x H1200mm
Y801548**	W1800 x H1200mm
Y801550**	W2400 x H1200mm

** Please specify colour when ordering

Tamperproof Noticeboards

A. Standard tamperproof noticeboards

Inexpensive solution to protecting displayed information against casual interference.

- Each door secures with 2 matching lock for convenience
- Surface accepts Velcro® or pins - colour fast to BS1006
- Available in 5 standard felt colours - Blue (BL), Burgundy (BG), Green (GR), Grey (GY), Red (RD) or Light Blue (LB)

Single Door

YLN31**	W450 x H600mm	each
YLN32**	W600 x H900mm	each
YLN33**	W900 x H900mm	each
YLN34**	W1200 x H900mm	each
YLN34**	W1200 x H1200mm	each

Double Door

YLN64**	W1800 x H1200mm	
YLN84**	W2400 x H1200mm	

** Please specify colour when ordering

B. Light oak effect premium aluminium frame EcoColour® tamperproof noticeboard

Stunning light oak effect aluminium frame with EcoColour® recycled material which is not only fire resistant but also has acoustics properties. Our popular EcoColour® material meets the relevant British Fire Safety Standards, and is fast becoming the preferred choice for fire resistant noticeboards in the UK.

- Noticeboard is classified a 'B' according to BS EN13501-1
- Made from recycled material
- Acoustic properties up to NRC 0.8
- Attractive contour frame design
- Available in 11 different colours

Single Door

Y801700**	W600 x H900mm	
Y801702**	W900 x H1200mm	
Y801704**	W1200 x H1200mm	

Double Door

Y801706**	W1800 x H1200mm	
Y801708**	W2400 x H1200mm	

** Please specify colour when ordering

C. Light oak effect premium aluminium frame loop nylon tamperproof noticeboard

Stunning light oak wood effect aluminium frame with a traditional yet contemporary finish without the maintenance of real wood.

- Attractive contoured frame design
- Available in standard loop nylon fabric in 17 colours
- Use with pins or Velcro
- Concealed corner fixings and matching keys

Single Door

Y801570	W900 x H600mm	
Y801572	W1200 x H900mm	
Y801574	W1200 x H1200mm	

Double Door

Y801576	W1800 x H1200mm	
Y801578	W2400 x H1200mm	

** Please specify colour when ordering



A

Felt colours:



Ideal for escape routes/corridors

Acoustic Properties



FIRE RESISTANT

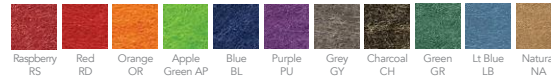

B



C

Colour Options

See page 386 for 18 loop nylon colour options



A



Please note: these items are made to order

B



Frame colours



Standard Loop Nylon Range

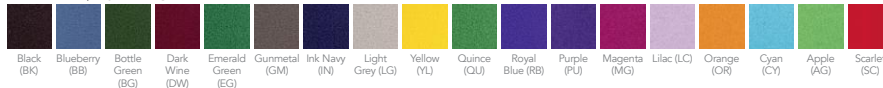

Tamperproof Noticeboards

A. Colourtone vibrant tamperproof noticeboards

- Stunning range of lockable notice boards in 6 colours
- 2 matching locks per door
- Full length glazing bars and quality hinges
- Aluminium frame, with fixings

Single Door

Y31012**	W600 x H900mm
Y31014**	W900 x H900mm
Y31016**	W1200 x H900mm
Y31017A**	W1200 x H1200mm

Double Door

Y31019A**	W1800 x H1200mm
Y31021A**	W2400 x H1200mm

** Please specify colour when ordering

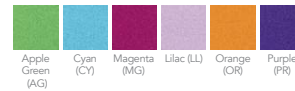

B. Premium tamperproof noticeboard

Contemporary framed lockable noticeboard.

- Contemporary styling with a wide range of frame and cloth colours
- Available in 6 different sizes all with standard loop nylon cloth
- Heavy duty design with 3mm thick PET covers and full length glazing bars
- Key Lock
- No door options are also available - please ask for details

Single Door

	Aluminium Frame	Coloured Frame
Y801260**	W600 x H900mm	
Y801262**	W900 x H900mm	
Y801264**	W900 x H1200mm	
Y801266**	W1200 x H1200mm	

Double Door

Y801268**	W1800 x H1200mm
Y801270**	W2400 x H1200mm

** Please specify colour of material and frame when ordering

Interior Showcases

A. Premium interior showcases

The elegantly styled premium Showcase has a top hinged door with support stays and 2 matching locks. Pinnable area is based on multiples of A4 sheets to maximise space utilisation. Standard & Resist-a-Flame versions are available.

- Each unit has two locks with matching keys
- Framework is available in anodised Aluminium (AL) or powder coated in Blue (BL), Red (RD), Green (GR), White (WH), Black (BK) or Light Oak (LO)
- Standard version are available in 12 popular loop nylon colours, accept pins and Velcro®.
- Resist-a-Flame® versions available, fully constructed to meet the latest building and fire regulations
- Tested to the relevant European 'reaction to fire' tests
- Easy to mount with concealed bracket, fixings provided



Light Oak Effect Frame

Standard showcases

YINTL4**	W712 x H570mm (A)
YINTP4**	W537 x H750mm (B)
YINTL8**	W967 x H750mm (C)
YINTP8**	W752 x H1050mm (D)
YINTP12**	W1012 x H1050mm (E)
YINTP15**	W1182 x H1050mm (F)
YINTP18**	W1397 x H1050mm (G)

EcoColour® Resist-a-Flame® showcases

Y801580**	W712 x H570mm (A)
Y801582**	W537 x H750mm (B)
Y801584**	W967 x H750mm (C)
Y801586**	W752 x H1050mm (D)
Y801588**	W1012 x H1050mm (E)
Y801590**	W1182 x H1050mm (F)
Y801592**	W1397 x H1050mm (G)

** Please specify colour of material and frame when ordering



Please note: these items are made to order

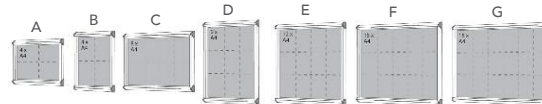

Standard Loop Nylon Range

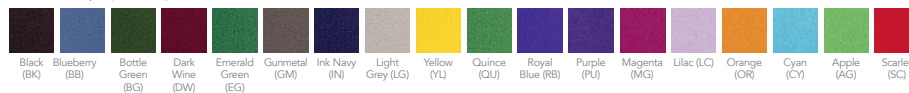

EcoColour® Resist-a-Flame® Range



Frame colours





A



Resist-a-Flame Woven Cloth Range



Please note: these items are made to order



B



Acoustic
Properties

EcoColour® Resist-a-Flame® Range



Resist-a-flame® Noticeboards

A range of fire retardant noticeboards fully constructed to meet the latest building and fire regulations, tested to the relevant European 'reaction to fire tests' these products are classified B-S1,d0 according to BS-EN 13501-1.
Ideal for use in public buildings and commercial applications, and for use in primary fire routes.

A. Aluminium framed fire resistant noticeboards

- Fire retardant noticeboards with aluminium frames
- Fully assembled boards certified to BS EN13501
- Fire retardant woven cloth
- Range of 10 standard colours

Y31020**	W900 x H600mm
Y31022**	W1200 x H900mm
Y31024**	W1200 x H1200mm
Y31025**	W1500 x H1200mm
Y31026**	W1800 x H1200mm
Y31028**	W2400 x H1200mm

**Please specify colour when ordering.



B. Tamperproof EcoColour® fire resistant noticeboards

Our popular EcoColour® material meets the relevant British Fire Safety Standards, and is fast becoming the preferred choice for fire resistant noticeboards in the UK

- Side hinged lockable noticeboards
- Noticeboard is classified a 'B' according to BS EN13501-1
- 2 locks per door with matching locks
- Clear covers tested to BS 476 part 7 class 1
- Range of 11 standard colours
- Acoustic properties up to NRC 0.8

Single Door

Y801620**	W600 x H900mm
Y801624**	W900 x H1200mm
Y801625**	W1200 x H1200mm

Double Door

Y801626**	W1800 x H1200mm
Y801628**	W2400 x H1200mm

**Please specify colour when ordering.

Resist-a-flame® Noticeboards

A. Top hinged tamperproof EcoColour® fire resistant noticeboards

Our popular EcoColour® material meets the relevant British Fire Safety Standards, and is fast becoming the preferred choice for fire resistant noticeboards in the UK.

- Top hinged lockable noticeboards with door supports
- Ultimate choice for use in corridors
- Doors open upwards and kept in place with support stays
- 2 locks per doors with matching keys
- Range of 11 standard colours
- Noticeboard is classified a 'B' according to BS EN13501-1

Single Door

Y801630**	W900 x H600mm
Y801632**	W900 x H900mm
Y801634**	W900 x H1200mm
Y801636**	W1200 x H900mm
Y801638**	W1200 x H1200mm

Double Door

Y801640**	W1800 x H900mm
Y801642**	W1800 x H1200mm
Y801644**	W2400 x H1200mm

**Please specify colour when ordering.

EcoColour® Resist-a-Flame® Range



Please note: these items are made to order

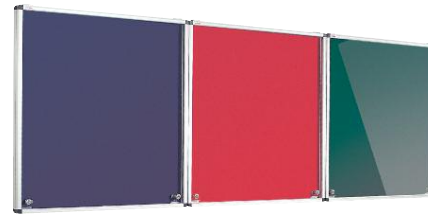

B. Premium sliding door EcoColour® fire resistant showcases

- Sliding lockable door option, ideal for busy corridors
- Doors manufactured from toughened safety glass
- Range of 11 standard colours
- Available in 4 sizes designed to take a given number of A4 sheets
- Framework is available in anodised Aluminium (AL) or powder coated in Blue (BL), Red (RD), Green (GR), White (WH) or Black (BK)

Y801612**	W967 x H750mm
Y801614**	W1012 x H1050mm
Y801616**	W1182 x H1050mm
Y801618**	W1397 x H1050mm

** Please specify colour of material and frame when ordering

Frame colours

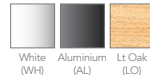

EcoColour® Resist-a-Flame® Range



Light Oak Effect Frame





Please note: these items are made to order

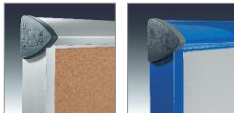

Freestanding Exterior Showcases

A. Premium post mounted exterior showcases

- Post mounted weatherproof showcase for sinking into concrete or bolting onto a sound base
- Specification as per premium Exterior Showcase, with the addition of powder coated steel backing plate for rear weatherproofing
- Galvanised and powder coated heavy duty steel posts to take single or double sided showcases
- Two post options are available for bolting down, or concreting into the ground
- Finished height of the unit is 2.0m
- Available in four size options, supplied as a single showcase and a pair of applicable posts
- Extra showcase available individually to create a double sided unit
- Please specify frame and infill colours required

Direct delivery 2-3 weeks

Sunken posts

		Takes
YPMS9**	W752 x H1050mm	9 x A4
YPMS12**	W1012 x H1050mm	12 x A4
YPMS15**	W1182 x H1050mm	15 x A4
YPMS18**	W1397 x H1050mm	18 x A4

Bolt down posts

		Takes
YPMB9**	W752 x H1050mm	9 x A4
YPMB12**	W1012 x H1050mm	12 x A4
YPMB15**	W1182 x H1050mm	15 x A4
YPMB18**	W1397 x H1050mm	18 x A4

Extra showcase (without posts)

		Takes
YEXS9**	W752 x H1050mm	9 x A4
YEXS12**	W1012 x H1050mm	12 x A4
YEXS15**	W1182 x H1050mm	15 x A4
YEXS18**	W1397 x H1050mm	18 x A4

** Please specify colour of material and frame when ordering

Light Oak Effect Frame Option



Frame colours



Wall Mounted Exterior Showcases

A. Premium exterior showcases

Popular covered noticeboards that are designed to protect your information against the elements. All showcases are truly weatherproof and meet the IP55 requirements of EN60529 for water and dust ingress.

- Wall mounted units have top hinged doors with support stays and two matching locks
- The internal display area is based on displaying multiples of A4 sheets of paper
- Framework is available in anodised Aluminium (AL) or powder coated in Blue (BL), Red (RD) or Green (GR), White (WH), Black (BK) or Light Oak Effect (LO)
- The internal display area is pinnable with a choice of 18 standard loop nylon colours or cork
- Supplied complete with fixings



YEXTL4**	W712 x H575mm (A)
YEXTP4**	W537 x H750mm (B)
YEXTL8**	W967 x H750mm (C)
YEXTP8**	W752 x H1050mm (D)
YEXTP12**	W1012 x H1050mm (E)
YEXTP15**	W1182 x H1050mm (F)
YEXTP18**	W1397 x H1050mm (G)

** Please specify colour of material and frame when ordering

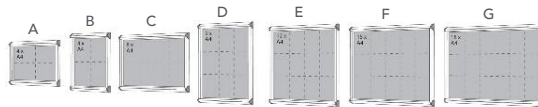

Please note: these items are made to order

Standard Loop Nylon Range

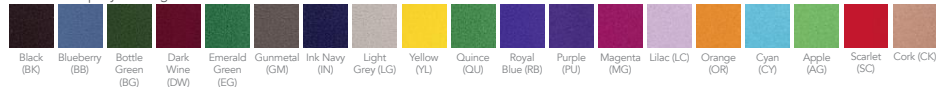

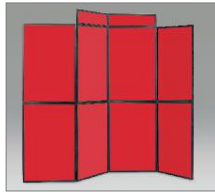
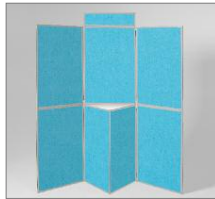
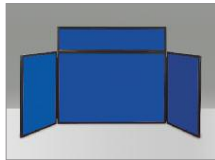
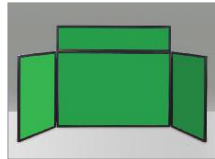

Please note: these items are made to order



EDB3PH Mini Table Top
Overall Size
W1800 x H800mm
Weight 3kg

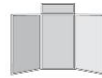

MXT69 Maxi Table Top
Overall Size
W1800 x H1100mm
Weight 4kg



6 Panel + Header



7 Panel + Header & Triangular Shelf



8 Panel + 2 Headers



10 Panel + 2 Headers & 2 Triangular Shelves

Standard colours



Extended colour range - allow an additional 2-3 days for delivery

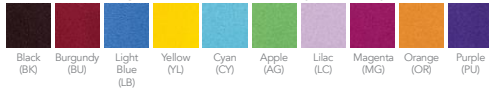

Folding Display Systems

A. Lightweight tabletop displays

- Ideal for presentations and displays, course work or exhibitions and fairs
- Double sided panels fold down to 900 x 600mm.
- All panels are double sided with a choice of loop nylon covering, which accepts Velcro® or Busyfix as well as pins
- Available in landscape or portrait formats
- All come with header panels and carry bags
- 4 standard and 10 extended loop nylon colour options
- Black or grey frame options

Maxi: Portrait All 3 panels 600 x 900mm
Header panel 600 x 200mm

Mini: Landscape centre panel 900 x 600mm
Side panels 450 x 600mm
Header panel 900 x 200mm

YMXT69** Maxi Table Top

YEDB3PH** Mini Table Top

Lightweight folding display systems

- Features as for the tabletop display system above
- 600 x 900mm panels are linked with flexible hinging, and clip on top of each other for easy assembly

B. Fast fold 6 panel system

- 6 x 600mm x 900mm panels
- 1 x 600mm x 200mm header • Weight: 8.5kg

YEDB6P** 6 Panel

C. Fast fold 7 panel

- 7 x 600mm x 900mm panels, 1 x triangular shelf
- 1 x 600mm x 200mm header • Weight: 13.7kg

YEDB7P** 7 Panel

D. Fast fold 8 panel

- 8 x 600mm x 900mm panels
- 2 x 600mm x 200mm headers • Weight: 11kg

YEDB8P** 8 Panel

E. Fast fold 10 panel

- 10 x 600mm x 900mm panels
- 2 x 600mm x 200mm headers
- 2 x triangular shelves • Weight: 24kg

YEDB10TP** 10 Panel

F. Panel bags

YBAG69S Standard Bag (Holds 7-8 Panels)

YBAG69LG Large Bag (Holds 10 Panels)

** Please specify colour when ordering

Folding Display Systems

Heavy duty system kits

- Buy the complete package - heavy duty system kits which include headers and a carrying bag
- These packages are a convenient and cost effective solution for purchasing a folding display system
- Robust system framed in aluminium
- Folding panel system with 700 x 1000mm panels, framed with anodised aluminium interlocking gear hinge, which prevents daylight showing between the panels
- Top and bottom panels lock on top of each other for greater security
- Available in 3, 6 or 7 panels with a single header, while the 8 panel option has 2 headers
- The system is stored in a rugged carry bag
- Double sided panels are covered in a choice of 4 loop nylon colourways which are fire retardant to BS5867
- Accepts Velcro® as well as pins
- Available in 4 standard & 10 extended range colours

YDB3P**	3 Panel with Header
YDB6P**	6 Panel with Header
YDB7P**	7 Panel with Header
YDB8P**	8 Panel with 2 Headers

** Please specify colour when ordering

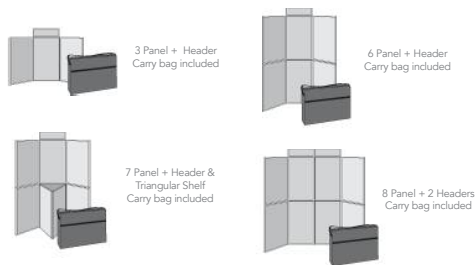

Standard colours



Extended colour range - allow an additional 2-3 days for delivery

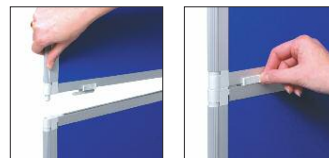
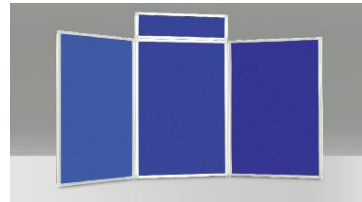
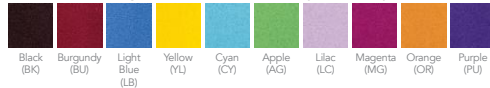

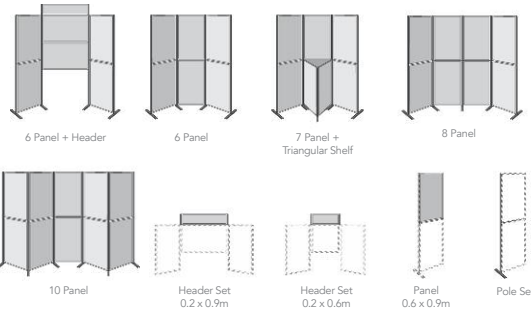
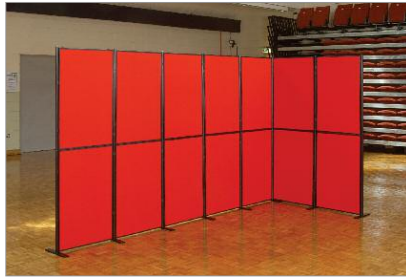

Standard colours



Extended colour range - allow an additional 2-3 days for delivery



Folding Display Systems

Onboard pole and panel display systems

- A lightweight pole and panel system that due to its modular design enables the user to reconfigure and extend the display system to meet the application
- Standard 600 x 900mm panels can be mounted both portrait or landscape onto the 1800mm high pole, using C clips provided
- The system can be extended at any point in the future by purchasing another kit to link on
- All panels are doublesided with a choice of loop nylon covering, which accepts Velcro or Busyfix as well as pins
- Header panels have loop nylon fabric on one side and black on reverse
- Available in 4 standard colours & 10 extended range colours

A. 6 panel kit – 9.5kg

YPPDB6H**	6 – 600 x 900mm Display Panels	
	1 – 900 x 200mm Header	
YPBAG78	Panel Bag - 7-8 Pane	each

B. 6 panel kit – 9kg

YPPDB6**	6 – 600 x 900mm Panels	
YPBAG78	Panel Bag - 7-8 Pane	each

C. 7 panel kit – 10kg

YPPDB7H**	7 – 600 x 900mm Display Panels	
	1 – Triangular Shelf	
YPBAG78	Panel Bag - 7-8 Panel	each

D. 8 panel kit – 10.5kg

YPPDB8**	8 – 600 x 900mm Panels	
YPBAG78	Panel Bag - 7-8 Panel	each

E. 10 panel kit – 14.5kg

YPPDB10**	10 – 600 x 900mm Panels	
YPBAG10	Panel Bag - 10 Panel	each

F. Accessories

YHEAD62**	Header Panel 200 x 600mm	each
YHEAD92**	Header Panel 200 x 900mm	each
YPNL96**	Extra Panel 600 x 900mm	each
YPOLESET	Pole Set Black	set

** Please specify colour when ordering these products



Concertina Mobile Room Dividers

- Ideal for temporary room divisions
- Double sided and available in 3 heights and 4 panel configurations (each panel is 560mm wide)
- A wide range of colours in velcro friendly Nylon loop
- Also available in elegant wool mix fabric
- Each panel comes with two lockable castors and folds neatly for easy storage
- Delivery 5-7 working days

Best Seller

Code	Description	Height
YCD124**	4 Panel	1200mm
YCD125**	5 Panel	1200mm
YCD127**	7 Panel	1200mm
YCD129**	9 Panel	1200mm

YCD154**	4 Panel	1500mm
YCD155**	5 Panel	1500mm
YCD157**	7 Panel	1500mm
YCD159**	9 Panel	1500mm

YCD184**	4 Panel	1800mm
YCD185**	5 Panel	1800mm
YCD187**	7 Panel	1800mm
YCD189**	9 Panel	1800mm

** Please specify colour when ordering



Please note: for safety reasons the room dividers cannot be used flat and must be angled for stability purposes. Using zig-zag configuration, it is recommended that 2 panels = 1 metre

Available colours

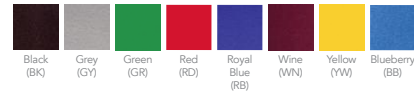

A



Available in:



B



Available in:



C



Available in:



Literature Display

A. Visual wall mounted literature display

Ever popular, colourful leaflet dispensers

- Curved, colourful, moulded body
- Concealed wall fixings
- 6 different sizes to suit a variety of leaflet sizes
- Available in 10 different colours

Y800500**	3 x A4	W267 x H521mm
Y800510**	6 x A4	W502 x H521mm
Y800520**	4 x A5	W184 x H521mm
Y800530**	8 x A5	W352 x H521mm
Y800540**	4 x ½ A4	W134 x H521mm
Y800550**	8 x ½ A4	W255 x H521mm

** Please specify colour when ordering

B. 4-sided revolving literature dispenser

- Clear acrylic pockets
- Chrome central column
- W560 x D560 x H1690mm
- 3 different options available in 4 different colours
- Also available in Orange, Lime or Lilac - please enquire for pricing

Y800600**	12 x A4
Y800610**	16 x A5
Y800620**	32 x ½ A4

** Please specify colour when ordering

C. Curve free standing literature display

- Stylish literature dispenser with sturdy steel frame
- Two widths available - single A4 or double A4 side by side
- Header panel for personalisation
- Supplied with set of 4 optional castors for mobility
- Simple self assembly required
- D310 x H1430mm
- Available in 3 colours

Y800300**	Single A4 Per Shelf	W350mm
Y800350**	Double A4 Per Shelf	W500mm

** Please specify colour when ordering

Poster Frames

A. Aluminium poster frames

- Budget poster frame
- Frame snaps open and shut to change the poster
- Satin anodised aluminium frame
- Anti-glare uv resistant cover
- Internal use
- For quantities of more than 10, please ask for prices

Y31005	A4 W210 x H297mm
Y31007	A3 W297 x H420mm
Y31009	A2 W420 x H594mm
Y31011	A1 W594 x H840mm
Y31013	A0 W840 x H1189mm
Y31015	B2 W500 x H700mm
Y31017	B1 W700 x H1000mm



A

B. Coloured poster frames

- Brightly coloured aluminium frame
- Frame snaps open and shut to change the poster
- Available in 5 striking colours
- Internal use

Y800200**	A4 W210 x H297mm
Y800210**	A3 W297 x H420mm
Y800220**	A2 W420 x H594mm
Y800230**	A1 W594 x H840mm
Y800240**	A0 W840 x H1189mm
Y800250**	B2 W500 x H700mm
Y800260**	B1 W700 x H1000mm

** Please specify colour when ordering

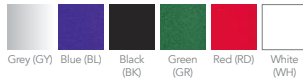

Grey (GY) Blue (BL) Black (BK) Green (GR) Red (RD) White (WH)



B

C. External tamperproof poster frames

New snap frame design is fitted with a weather-proof seal preventing water damage. The special frame profile and higher strength springs prevent casual tampering as a unique tool is required to open the frame.

- Weatherproof and tamperproof design
- Supplied with opening tool
- Ultraviolet protective film prevents fading

YEPF1000	A4 W210 x H297mm
YEPF1001	A3 W297 x H420mm
YEPF1002	A2 W420 x H594mm
YEPF1003	A1 W594 x H840mm
YEPF1004	A0 W840 x H1189mm
YEPF1005	B2 W500 x H700mm
YEPF1006	B1 W700 x H1000mm



C



New
Lower
Prices

Premium glazed display cases

A stylish range of display cases manufactured to the highest standard. Heavy duty yet contemporary aluminium framing, and toughened safety glass are used to create this range of wall and freestanding showcases.

- Delivered fully assembled
- Choice of 2 frame finishes - anodised satin silver or powder coated blue
- 6mm toughened safety glass
- Adjustable shelves
- Lockable castors
- Optional header and/or bottom cupboards - price on request
- Illuminated version comes complete with 4 halogen lights



A. Wall cabinet with sliding doors

Size H1000 x W1000 x D250mm

Y801800	Satin Silver
Y801805	Blue

Illuminated

Y801810	Satin Silver
Y801815	Blue

B. Tower unit with hinged door

Size H1932 x W500 x D500mm

Y801820	Satin Silver
Y801225	Blue

Illuminated

Y801830	Satin Silver
Y801835	Blue

C. Wide tower unit with sliding doors

Size H1932 x W1000 x D450mm

Y801840	Satin Silver
Y801845	Blue

Illuminated

Y801850	Satin Silver
Y801855	Blue

Please note: these items
are made to order

Premium plus glazed display cases

The Premium Plus range of glass display cases offers a contemporary modern styling to the aluminium frame.

- Delivered fully assembled
- Anodised satin silver aluminium construction
- 6mm toughened safety glass
- Lockable doors
- Adjustable shelves
- Lockable castors
- Three top-fitted halogen lights as standard
- Button feet available on request
- Optional side strip light - price on request



A. Tower display case with hinged door
• H1932 x W735 x D317mm

Y801860



B. Tower display case with sliding door
• H1932 x W1135 x D317mm

Y801865



Page Link - see pages
For Reception
Desks → 287-297



Page Link - see pages
For Reception
Seating → 218-246



Page Link - see pages
For Artificial
Plants → 298



A



Please note: these items are made to order

B



New Product

C

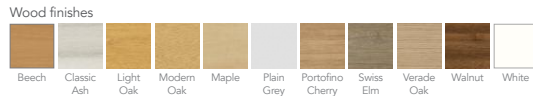

Lecterns

A. Panel front lectern

Practical mobile lectern

- Popular mobile lectern finished in beech look panelling and grey steel framework
- Upper shelf angled with book rest to aid presentation, together with lower accessory shelf
- Lectern mounted on four castors two of which are locking

	(H)	(W)	(D)
YPFLECT	1200	x 600	x 450mm

B. Coloured panel front lecterns

- A colourful addition to the popular beech version
- New contemporary range of 7 colours
- Dark grey steel framework
- Dimensions: H1200 x W600 x D450mm

Y31019	Orange
Y31021	Blue
Y31023	Lime Green
Y31030	Grey
Y31027	Black
Y31029	Red
Y31031	White

C. Static lectern

- Stylish lectern for a perfect fit in all environments
- Small shelf provides space for notes and drinks
- Space for routing microphone wires internally
- W600 x D400 x H1170mm
- Available in 11 different wood finishes with 4 metal trim colours

Y800910	Static Lectern
---------	----------------

AV Cabinets

A. Multi-media projector cabinet

- Economical multi-media cabinet
- House all your multi-media equipment and accessories in this secure locking mobile cabinet
- Three shelves, two fixed and one sliding for the projector
- Cable access port to top and side for easy connectivity
- Finished in beech with ABS edging
- Size: H930 x W524 x D570mm

YMMPCBH Multi-Media Projector Cabinet, Beech



A

B. Premium multi-media projector cabinet

- Premier mobile multi-media cabinet
- Market leading cabinet with extra security and features
- Designed to house all multi-media projection equipment.
- Three point lock for added security.
- Contoured rounded edging to top and base panels
- Rear hinged panel for easy access to cabling.
- Additional cable ports and cable tidy
- Accessory storage tray to inside of door
- Size: H930 x W524 x D570mm

YSCMPBH Premium Multi-Media Projector Cabinet, Beech



B

Please note: these items are made to order

C. Premium coloured mobile multi-media cabinets

- The premium cabinet has now been developed in a range of 7 striking colours
- Premier coloured secure projector cabinets designed to house all multi-media projection equipment
- Rear lockable access door
- 4 shelves, 3 of which slide
- Ready assembled in 7 colours
- Size H930 x W524 x D570mm

Y31033	Red
Y31036	Grey
Y31037	Orange
Y31039	Blue
Y31041	Lime Green
Y31043	Black
Y31045	White



C



Creating sustainable learning environments for pupils & teachers
Effective acoustic solutions for a wide range of education environments.
Combine aesthetics and design with acoustic performance, for all education environments.



SPACES TAYLORED

Acoustic Surfaces

The Hide	403
Acoustic Surfaces	404-406
Acoustic Panels	407

Main Content Page



Acoustic Surfaces





The Hide

A virus protected, personal acoustic screen

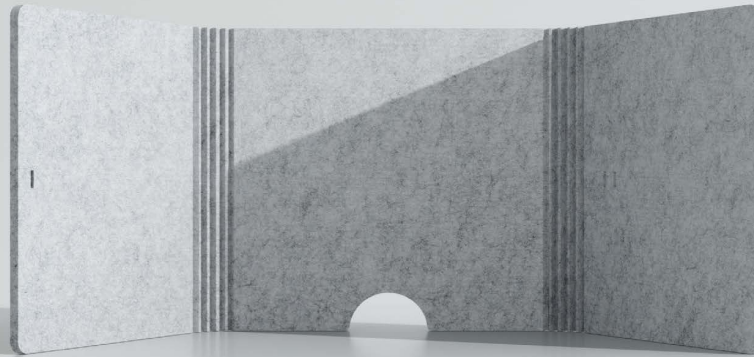

- HIDE 500 screen for greater sound attenuation and privacy
- HIDE 500 is excellent for sharing in common areas and temporary office workstations whilst hot-desking
- Great for quiet study
- HIDE folds as easily as it opens and stays folded with a convenient self- seal strap

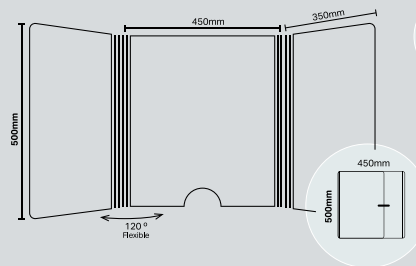

The Hide

HIDE500 300 x 450 x 500mm Panels each

*Please specify colour when ordering
**Order in bundles of 4





HushBoard Acoustic Surface

HushBoard is a superb decorative wall covering, specifically developed to enhance the educational environment. Its felt surface transforms noisy interiors as well as creating a colourful, highly durable and exciting surrounding.

- Perfect for use in schools, colleges and nurseries
- Improves teaching and learning by absorbing excess classroom noise
- Acoustic rating of NRC 0.40 is proven to reduce noise levels by 40%
- Pin, staple and velcro friendly, perfect for displays!
- Highly durable, resistant to staining and easily cleaned
- Saves the time and expense of recovering traditional wall boards
- Large range of 35 eye-catching, non fade colours
- Professional fitting service available for your own imaginative designs
- Recommended for a minimum 8 year cycle
- Fire retardant
- Call today for a sound survey and free quotation

Page Link - see pages

For
acoustic
noticeboards

384-385



Pin, staple &
Velcro friendly



Acoustic Surfaces

Transform your environment and comply with acoustic directives.



Avocado Spearmint Sage Jade Lime Wasabi Granny Smith Azure Octane Stately Ink



Stonewash Atlantis Electric Blue Calypso Blush Phantom Raspberry Theatre Chili Red Blazing Red Lightsout



Cinder Citrus Clay Simba Vintage Brilliant Orange Bark Porcelain Myst Fawn Sanz



Koala Silver Civic Charcoal Noir

Due to the limitations of print, colours will vary from those shown above

Acoustics - The Basics

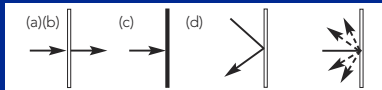

- (a) Sound transmission - the sound passes through the surface into the space beyond
- (b) Absorption - the surface absorbs the sound like a sponge absorbs water
- (c) Reflection - the sound hits the surface and changes direction like a ball bouncing off a wall. This creates reverberated noise.
- (d) Sound Diffusion - the sound strikes the surface and is scattered in many directions, like pins being hit by a bowling ball

Statistics have shown that 25% of children cannot hear properly in the classroom which can result in learning difficulties. Install hushboard and boost their learning performance.

Call for a FREE sample swatch for accurate colour selection

Other products from the Hush range

Colours may vary



HushBlox

Stackable acoustic blocks allowing you to configure your learning space any way you want



HushTree

Large room divider providing acoustic properties with a fun and aesthetically pleasing design

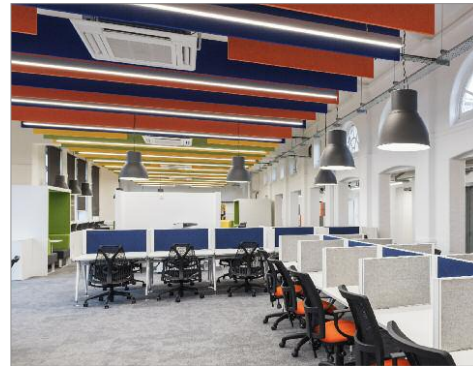
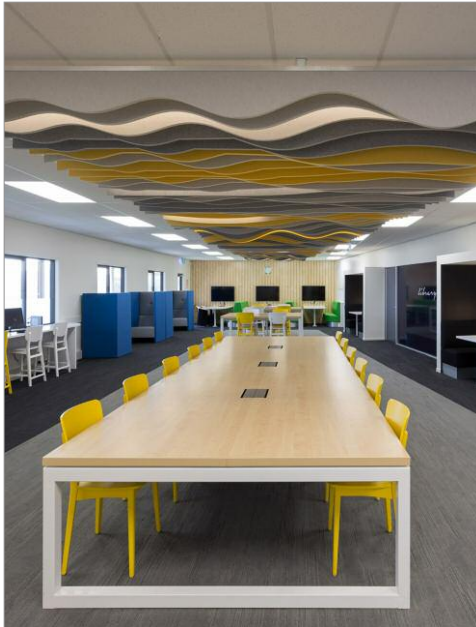

Page Link - see page
Static
seating
range shown

184-185



Acoustic Panels

HushPanel is an innovative 25mm or 50mm thick acoustic panel, that is engineered to provide superior sound absorption with balanced acoustic design. Ideal for wall and ceiling applications, HushPanel is unique in it's availability to be supplied as either a pre-finished panel covered with HushTex acoustic fabric, plain format or custom printed with any image, colour or pattern giving you the flexibility and freedom to create your own designs.

Acoustic Panels

These panels can be hung from the ceiling to absorb sound or hung from the ceiling to create 'rooms' with acoustic properties

- Perfect for classrooms, corridors, theatres, communal areas and gymnasiums
- HushPanel transforms noisy interiors to quieter working areas whilst creating colourful and exciting surroundings
- HushPanels are flame retardant, semi rigid, impact resistant, and incredibly durable
- The panels are supplied in sheet form that can be cut and framed onsite, allowing for variations in wall size and shape
- They can also be supplied as custom cut and shaped for increased design flexibility
- This quality product fully answers to the criteria needed for BB93 Noise Level Compliance
- Frames and edge finishing kits are available allowing greater flexibility for constructing large wall areas or unique modular panels

Please contact us for further details and a full technical specification.

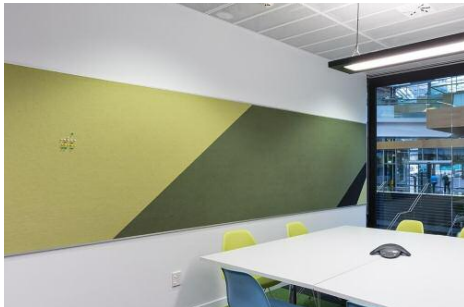

A wide range of standard colours are available as well as bespoke colours and designs. Please enquire for details.

Acoustic Panels 'eat up echo'





Is your playground the Great Outdoors?

Our outside equipment, canopies and seating add that special combination of practicality and fun for all ages.



SPACES TAYLORED

Outdoor Furniture

A-Frame Benches	410
Circular Tables	411
Multicoloured Seat & Bench	412
Cotswold Range	413
Learning Curve	414
Stone Effect Furniture	415
Lockers, Cycle lockers	416
Bins	417-419
Bike Racks	419

[Main Content Page](#)

Outdoor Furniture

We can help you to create fun and pleasant outdoor areas for children and adults alike.

Whether you are looking for some outdoor benching for the teachers to enjoy or a climbing frame for the children, we would love to hear from you.

Take some time to peruse the products and pictures in this Outdoor section and don't hesitate to contact us to discuss your requirements and find out what we can do for you.





A



A. Outback a-frame table

Made of recycled plastic, and fully recyclable, these environmentally friendly A-Frames are totally weather proof and virtually maintenance free. To prevent "sag" in the seats - as is common with some plastic furniture - they have galvanised steel re-inforcing which we fit as an integral component during manufacture. Also available in other colours to order at extra cost (black, green, grey, light brown).

- Recycled Plastic – and fully recyclable
- Virtually maintenance free and very environmentally friendly
- Totally weather proof with galvanized steel reinforcing
- Built to seat 6 persons
- Size: Overall base L1800 x W1300mm; seat height 450mm, table height 755mm; table width 620mm

YW0032 Outback A-Frame Table



B



B. Outback bench

Made of recycled plastic, and fully recyclable, these environmentally friendly benches are totally weather proof and virtually maintenance free. To prevent "sag" in the seats - as is common with some plastic furniture - they have galvanised steel re-inforcing fitted as an integral component during manufacture. Also available in other colours to order at extra cost (black, green, grey, light brown).

- Recycled Plastic – and fully recyclable
- Virtually maintenance free & very environmentally friendly
- Totally weather proof
- Galvanized Steel Reinforcing
- Built to seat 4 persons
- Size: L1800 x D670 x Seat Height 450mm, back height 770mm

YW9964 Outback Bench

C



C. Standard 6 seater a-frame table

These tables stand the rigorous demands of outdoor use. This traditional design has strength and quality as standard. The table is 1500mm long, and is manufactured using 34mm x 121mm timbers. They are immersed in white spirit based treatment for 3 minutes, which gives them their brown colour.

- Extremely strong design with a substantial construction
- Full immersion spirit treatment
- Timber from managed forestry resources
- Provision for optional parasol & base (extra)
- Re-treatment kits available
- Size: Overall base L1500 x W1270mm; seat height 450mm, table height 760mm; table width 625mm

YW0501 Standard 6 Seater A-Frame Table

A. Circular 8 seater table

Designed for commercial use and built to last; from the double thickness tops to the 46mm x 196mm thick leg the durability is well balanced with user friendliness. These versatile heavy duty outdoor round picnic tables stand up to the rigors and heavy demands that you would expect.

- Built to take 8 persons – a real workhorse
- Free, clear leg room
- Most popular model in the circular tables range
- 1.2m diameter table top (approx)
- Full spirit immersion treatment throughout
- Provision for optional parasol and base (extra)
- FSC® Certified
- Table diameter 1200 x H740mm
- Seats W850 x H440mm
- Overall outer dimensions 1200 x 1935mm

YC8ST Circular 8 Seater Table



B. Circular 6 seater table

Designed for commercial use and built to last; from the double thickness tops to the 46mm x 196mm thick leg the durability is well balanced with user friendliness. These versatile heavy duty outdoor round picnic tables stand up to the rigors and heavy demands that you would expect. The circular 6 seater is ideal for anyone less able, with access for 3 wheelchairs.

- Easy access / egress seating
- Room for up to 3 wheelchairs
- Could help with your DDA programme
- Built to take 6 or 9 persons
- Table diameter 1200 x H740mm
- Seats W850 x W440mm
- Overall outer dimensions 2050 x 1820mm
- Optional parasol and base available at extra cost - POA

YC6ST Circular 6 Seater Table



A



A. Multicoloured seat

- Ready assembled
- Ground-fixing bolts
- Vandal-resistant
- Hygienic - easy-to-clean
- Environmentally friendly, made from recyclable plastic

YCPS2	2 Seater	H840 x L1350 x D620mm
YCPS3	3 Seater	H840 x L1850 x D620mm
YCPS4	4 Seater	H840 x L2050 x D620mm

Page Link - see page
For round bins... [417](#)



B



B. Clarendon teak bench

- High quality solid Teak finished to a high specification
- Engraving available - please ask for details

YCB12	1200mm
YCB15	1500mm
YCB18	1800mm

Outdoor Furniture

Cotswold Concrete & Wood Range

- Cast steel-reinforced concrete ends provide excellent stability
- Sturdy and robust; these benches offer an ideal solution for playgrounds and public areas
- All prices include delivery

A. Bench (no back)

YS00033 L1830 x W610 x H500mm



A

B. Park bench - with back

YS00020 L1830 x W835 x 430mm Seat Height



B



C

C. Rectangle picnic table wheelchair access

- Extended table top L2430 x W710mm

YS00014 Rectangle Wheelchair Access



D

D. Rectangle picnic table 8 seater

- Table: 1825 x 710mm, Seat height 450mm

YS00001 Rectangle 8 Seater



E

E. Round picnic table

- 1310mm diameter, 2000mm overall width
- Seats 8 adults comfortably

YS00021 Round Table



Item shown YLC1. Please ask for details of other options in this range.

A. Learning curve

- Seat Height: 380mm
- Length of each seat: 800mm
- Overall diameter: 2600mm
- Maintenance free and easy to clean
- Ground fixing supplied
- Recycled and recyclable plastic
- Simple self assembly is required

YLC1 2600mm Diameter

Page Link - see pages
For
Outdoor
Lockers

143



*Your imagination!
Your creation!
Flexible seating, with flat tops or
planter boxes.*

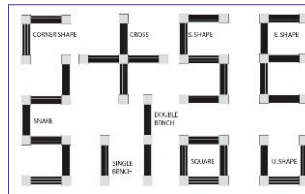

Call now
for a free
quotation



Other configurations available - please ask for details

Stone Effect Tables And Seating

- Highly popular maintenance free
- Ready assembled
- Available in stone colours only
- Vandal resistant
- Made from recycled and recyclable plastic

A. Premier bench without backs

YPB3	3 Seater	H410 x L1850 x D560mm
YPB4	4 Seater	H410 x L2050 x D560mm



A

B. Table set

- Table and 2 benches

YPTB6	6 Seater	L1850mm
YPTB8	8 Seater	L2050mm



B

C. Premier seats with backs

YPS3	3 Seater	H840 x L1850 x D620mm
YPS4	4 Seater	H840 x L2050 x D620mm



C

Plain colours



Stone effect colours



Page Link - see page

For round bins...

417



A



Page Link - see pages
For more
Outdoor
Lockers

143



A. Outdoor multi-purpose storage lockers

- These outdoor lockers are ideal for storage of outside items such as sports and training equipment, cricket and hockey bags, tool boxes, musical instruments and many other large items that clutter corridors and indoor rooms
- Hard wearing recycled polyethylene which is weather and vandal resistant
- Each locker can be supplied with either a padlock or integral keyed handle – Please state when ordering
- Lockers can be stacked and nested together to create a configuration that suits your space
- Wide range of Body colours available
- Available in two sizes – See below

Large Locker

YLMPL-P W550 x D700 x H550mm

Extra Deep Large Locker

YJMPL-P W550 x D1250 x H550mm

B



B. Cycle lockers

- These Outdoor Cycle Lockers are designed to hold most styles and shapes of bike
- A secure & environmentally friendly facility that can be used in car parks, Colleges, Stations, Leisure sites etc.
- Heavy Duty units made from recyclable weatherproof plastic
- Built-in floor with drainage holes for low maintenance and easy cleaning
- Comes with ground fixing bolts for hard surfaces
- Internal Storage hooks & ground fixing for securing bikes
- Comes with padlock and key
- Multiple lockers can be positioned together to form a range of layouts to suit your space –see diagram
- W960 x D1650 x H1250mm

YBBCL01

Single Unit



C



C. Woodrow Public Bench

- Units of 2 - 5 seat places
- Backless bench versions available
- Can be supplied with or without arms
- 2 units can be supplied as 1 back to back
- Extensive range of frame colours including bespoke finishes

YTT1050OD

A. Classic bins

- Can be printed - please ask for details
- Polyethylene outer shell
- Galvanised steel liner
- Lock and Key
- Weighted base
- Easy to clean
- Size: H1130 x 520mm diameter
- 90 litre capacity
- Available in all colours, stone colours shown in picture

YCLB Classic Bin Standard Design

Plain colours



Lt Green Yellow Purple Red Maroon Black Orange Dark Blue Light Blue

Stone effect colours



Red Granite Burgundy Chestnut Dk Millstone Emerald Pale Granite Sandstone Sapphire White Granite



A

B. Manor litter bin with lid

The removable, 40 litre, galvanised steel liners have a carry handle and are suitable for black plastic bin liners. These litter bins can be ground fixed through fixing holes in the feet - this comes as standard.

- Keep your property tidy with these smart litter bins!
- 40 litre, removable, galvanised liner
- Liner suitable for black plastic bin liners
- Matching removable lid
- Steel frame - can be fixed to the ground
- Size: H930 x W420mm

YW0189 Manor Litter Bin with Lid

C. Park litter bin

The removable, 40 litre, galvanised steel liners have a carry handle and are suitable for black plastic bin liners. These litter bins can be ground fixed through fixing holes in the feet - this comes as standard.

- 40 litre, removable, galvanised liner
- Liner suitable for black plastic bin liners
- Steel frame - can be fixed to the ground
- Size: H750 x W410mm

YW0226 Wooden

YW0226BC Bright Colours



B



C



Carriage may be charged on small orders, please enquire. More styles available - please ask for details.

D. Grit bins

Our roadside standard grit bins are perfect for helping you to keep your paths and driveways ice free.

- **Standard Grit Bin:** H710mm x W840mm x D500mm, capacity: 200 litres
- **Large Grit Bin:** H920mm x W1050mm x D670mm, capacity: 400 litres

YBBGBS Standard

YBBGBL Large



D

A



A. Wall/post mounted bin

- Lock and key
- Wall or post mounting
- Polyethylene bodyshell
- Internal galvanised steel liner
- Environmentally friendly - made from recyclable plastic
- Wall fixing bolts supplied
- Hygienic, easy to clean
- Size H675 x W440 x D310mm
- Capacity 26L



YMPFW



B



B. Strongbox recycling bin system - set of 4

- Polyethylene bodyshell
- Galvanised steel liner
- Pivoting bin for ease of emptying
- Hygienic - easy to clean
- Environmentally friendly - recyclable plastic
- Can be wall mounted
- Size: H920 x D400 x W510mm
- Capacity 39 litres

YRVP

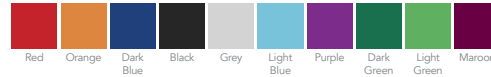

C



C. Tuftec litter bin

- Outdoor Heavy Duty 100L Tub Bin
- Contoured design with a wide base which allows for maximum capacity and stability
- 2 Piece design – lift off cover with an inner metal liner
- Concrete or soil fixings also available – POA
- Black finish
- Dimensions: H1030 x D540mm

YTTB100

A. Mushroom litter bins

- 90L capacity mushroom shaped bin
- Polyethylene bodyshell
- Galvanised steel liner
- Hygienic, easy to clean
- Made from recyclable plastic
- Supplied with a lock & key (use key to unlock and access liner bin)
- Available with or without printed spots
- Comes in 9 bright colours: Light Green, Yellow, Purple, Dark Blue, Light Blue, Orange, Maroon, Black and Red
- Size: H900 x D720mm

YMUL01	Without Spots
YMULS01	With Spots

Plain colours

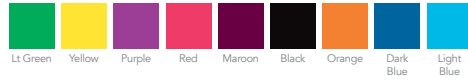

A

B. Pencil bins

- Polyethylene outer shell
- Galvanised steel liner
- Lock and Key
- Available in all plain colours

YPMIC	Micro; H1040, 390 dia. 42 Litre
YPMID	Midi; H1200, 390 dia. 52 Litre
YPMICL	Pencil Bin with 'Litter' Letters, 42 Litre
YPMIDL	Pencil Bin with 'Litter' Letters 52 Litre

Plain colours

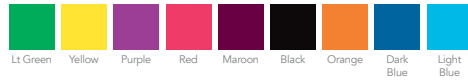

B

C. Wall mounted cycle holders

- Made from Heavy Duty Galvanised Steel
- Available with 90° or 45° angle to the wall

YSPR11	Cycle Holder	POA
--------	--------------	-----



C

D. Cycle toast rack

- 4m wide
- Made from heavy duty galvanised steel, comes flanged for bolting down only

YSPTR05	Galvanised For 10 Cycles	POA
---------	--------------------------	-----



D



Planning a school refurbishment over the holidays?

Or refreshing a 'tired' interior? We have the design experience and project 'know-how' to create and deliver the perfect result you're looking for without the hassle!



SPACES TAYLORED

Design & Refurbishment

Design & Build	422-423
Washrooms	424-425
Libraries & Learning Zones	426
Staffrooms & Tea Points	427
IT Suites	428
Cloakrooms & Changing Rooms	429
Reception Areas	430
Offices & Meeting Rooms	431
Science Laboratories	432-433
Home Economics	434
Classroom Refurbishment	435
Flooring	436-437
Ceilings & Lighting	438
Decorating	439
Outdoor Spaces	440-441

Main Content Page



Design & Refurbishment

Your new-build, extension or total refurbishment can safely be left entirely in our care. If you wish, we will undertake the whole process from initial consultation and plans right through to furniture, fittings and final sign off.

Or, if you prefer, we are happy to work with your architect or designer to bring your plans to life. Our aim is to relieve you of as much of the hassle as possible – leaving you to focus on what you are best at.

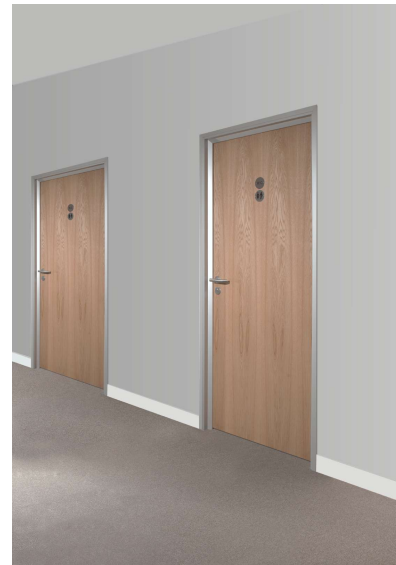



Design & Build

- Initial plans
- Liaising with the Local Authority
- Applying for Planning/Building Regulations approval
- Groundwork, foundations
- All construction work
- Plumbing, electrics, lighting, heating and ventilation
- Carpentry and joinery
- Carpets, wall coverings and decoration
- Furniture design and installation

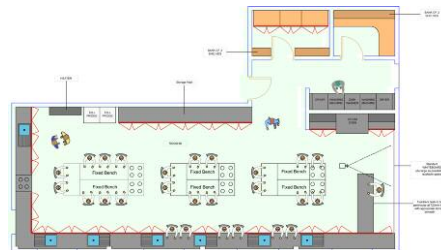

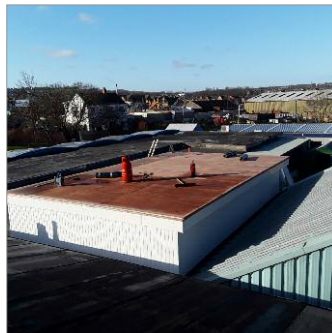



Washrooms

You might be surprised to know how many pupils (and parents) judge a school by its washrooms! A bright, colourful, hygienic and welcoming washroom environment can make a difference throughout the whole school.

Please contact us for details of the full range and for more advice.

Features & Options

- Fantastic selection of colour choices available
- Postformed vanity tops for fully-recessed or semi-recessed options
- Solid aluminium locks, hinges, headrail and adjustable feet
- Real high-pressure laminate face with impact resistant edging
- Ultimate durability
- Totally impervious to water
- Black profiled panel edges
- Low door and division height
- Option of print design doors
- Option of SGL or HPL core material



Washroom Accessories



Paper towel dispensers



Hand soap dispensers



Air-Blade hand dryers



Toilet roll dispensers



Mirrors



Infra red taps

Options & Accessories

We have a huge range of fixture and fitting options as well as our extensive range of colours, and materials.

- Heavy duty non slip vinyl provides a neat and cost effective flooring solution to wet areas
- Wall cladding uses matching material to the cubicles. It provides a cleanable robust surface with panels that can be removed if required
- Resin flooring uses a 3 layer system with metallic or mineral chips for durability & will not shrink or crack and is guaranteed for 25 years
- Ceramic tiles are ideal for washroom areas. There are a wide range of colours and sizes available, together with matching trims



Libraries & Learning Zones

Your new library or learning zone must provide efficient, practical and accessible storage of your learning resources. But if it is to fulfil its purpose it must also be attractive and welcoming for the pupils.

Please contact us for details of the full range and for more advice.

Page Link - see pages
For
Library
Furniture

193-203



- Huge range of shelving configurations, colours and finishes
- Choice of standard module sizes or bespoke
- Reading dens, benches and tables
- Flooring and décor design and installation



Staffrooms & Tea Points

Every school needs a quiet space for it's staff. Offering a wide range of materials and finishes and backed up by our experience and expertise we ascertain exactly what you need – and build it for you.

- Large range of comfortable and relaxing seating units
- Armchairs, coffee tables
- Flooring and décor design and installation
- Worktops, sinks and storage

Please contact us for details of the full range and for more advice.



IT Suites

Thoughtfully planned and carefully executed, a good IT suite will give many years of service. We can design and build the complete suite, including fixtures, fittings and cabling for each station.

Please contact us for details of the full range and for more advice.

Page Link - see page

For IT Furniture 156-158



- Flooring and décor design and installation
- Stylish and durable benching frames and tops
- Wide range of benching colours and finishes
- Range of chair designs and colours

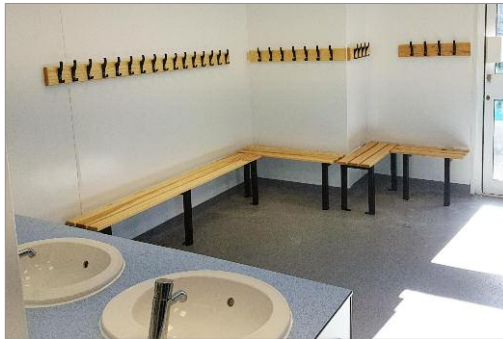

Cloakrooms & Changing Rooms

An area where intelligent design and robust construction are essential. We are able to design, plan and construct your cloakroom or changing room and complete it with all necessary fittings and storage lockers.

Please contact us for details of the full range and for more advice.

Page Link - see pages
For
Cloakroom
Furniture

136-147



- Flooring and décor design and installation
- Benching, racking and lockers
- Coat hooks



Reception Areas

With years of experience designing and fitting bespoke reception areas we can offer advice on every aspect of the process.

Even in the smallest and most awkward spaces we can deliver practical and beautiful solutions to suit your needs!

Please contact us for details of the full range and for more advice.

- Flooring and décor design and installation
- Wide range of reception desk styles, colour and finishes
- Fully bespoke design option available



Offices & Meeting Rooms

As well as our extensive ranges of office furniture featured in this catalogue, we can help you design, and build or refurbish your offices.

Our experienced designers use 2D and 3D CAD drawings to optimise your office space. Our skilled installation teams include electricians, joiners, plumbers and flooring fitters.

Please contact us for details of the full range and for more advice.

- Flooring and décor design and installation
- Range of desk styles, colours and finishes
- Range of chair designs and colours



Science Laboratories

- 16mm Trespa Toplab solid grade laminate worksurfaces
- Units come with MDF carcasses and laminate faced doors
- Turrets built and fitted to bespoke sizes for services including gas, water and electrics
- Removable back panels in base units allow access to pipework
- Full length steel drawer runners
- Vulcathene acid resistant waste pipework

- Grohe gas taps and water spouts
- Belfast sinks – range of sizes
- Large choice of surface colours and storage trays
- Matching furniture for Prep rooms
- Mobile steel tray storage
- Acid, poison and toxic chemical cabinets

Please contact us for details of the full range and for more advice.



Science Laboratory Options

- Powerbars
- USB ports
- Laptop trays
- Cable trays
- PC shelves
- Learning walls
- 270 degree hinges to the doors
- Corian worksurface option
- Draining grooves for the sinks
- Fume cupboards, built in or mobile
- Blackout blinds for light experiments

Please contact us for details of the full range and for more advice.

Trespa Top Colours Options



Speckled White

Speckled Pastel Grey

Speckled Powder Blue

Speckled Aquamarine

Speckled Icy Blue



Freestanding or Built-In Appliances



Home Economics

We offer a wide range of materials and finishes in all its configurations, whether you want wood finish, laminate or even Trespa, we can do it all.

- Optional bag stores
- 40mm Plexi-Form tops with D wrap laminate edging
- Ingredients storage units
- Fully integrated appliances if required
- Gas safe approved installation

- Warming drawers
- Corner carousels
- Extraction for adequate ventilation to regulation requirements
- Large range of colours of worksurfaces and finish options; units, floors, walls, stools
- Ask one of our Design Team to draw up a plan for your consideration

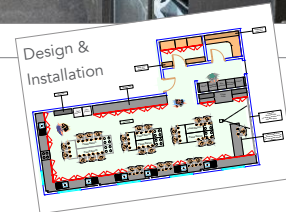



Classroom Refurbishment

Classroom getting tired? Needing a new layout? Short of storage space? Staff and children getting depressed? The answer is to call us in to refit your classroom. We will strip it out, redecorate, give it new flooring, new storage equipment, new furniture, new ceiling and lighting. In short – a bright and enthusiastic atmosphere for the start of term.

Please contact us for details of the full range and for more advice.

- Flooring
- Ceiling and lighting
- Decorating
- Tables and chairs
- Built-in storage furniture
- Boards and interactive whiteboards
- Windows and blinds



Flooring Options

We have an enormous range of flooring options, colours and patterns including carpeting, carpet tiles, vinyl and Polysafe flooring.

Please contact our experienced installation experts for advice about which materials are most suitable for your environment.

Please contact us for details of the full range and for more advice.

- Carpet tiles
- Vinyl
- LVT
- Refurb Parquet

Carpet tile finishes

Hard-wearing and highly functional, our carpet tiles are designed with affordable excellence in mind.

A professional, smart-looking tile, the plain tile is available in 24 block colours, which seamlessly combines with Essence Stripe, Structure and Maze, providing unprecedented creative design opportunities.

With its plain level loop pile structure, and a strong line of commercial colours, this product goes back to the pure essence of a flooring product.



Essence



Essence Structure



Essence Stripe



Essence Maze



Vinyl flooring

Altro is a hard wearing and practical commercial floorcovering available in a choice of gauges to suit the application. Not suitable for wet areas.

Featuring top-selling shades, representing the vast majority of volume sales, Standard XL is available in a duotone marbled decoration.



Black Cherry



Graphite



Mushroom



Atlantic Blue



Black Panther



Slate Grey



Suspended Ceilings & LED Lighting

Pupils' activity levels vary over the school day and as more schools use flexible desk arrangements, lighting and ceiling solutions need to be designed accordingly.

Lighting and ceilings play a significant role in contributing to the happiness and well-being of teachers and pupils. A well designed and flexible lighting solution will support activities and give uniform brightness throughout the room.



Circular steel rimmed
single pendant



Round interior
bulkhead fitting



600 x 600mm LED panel



Single stainless pendant



Decorating

Our decorating teams will work with you to cause the least disruption possible while work is in progress. They work fast, accurately and quietly, and will carefully clear up at the finish.

To us, this is the most important factor. The fact that you get a beautifully decorated space is a bonus.

Please contact us for details of the full range and for more advice.





Outdoor Spaces

Let us transform your outdoor space into an interesting and engaging play and relaxation area. We can undertake all aspects of design and installation.

See page 408 for outdoor furniture

Please contact us for details of the full range and for more advice.

- New hard and soft surfacing
- Fencing/walling
- Canopies
- Pergolas
- Gazebos
- Shade sails
- Play equipment
- Sheds and huts



A

Acoustic Surfaces	402-407
Activity Rugs	122-123
Adjustable Tables	24,130,131,132,344-345
Alu Lite Staging	210
Art & Paper Storage	75,85
Auditorium Seating	215
AV Cabinets	401

B

Baby Changing Units	114
Bean Bags	117,118,203
Beds, Dormitories	334-337
Benches, Outdoor	410-415

Bespoke Furniture

IT Suites	150-151
Libraries	190-193
Multiwall	95
Receptions	288-301
Storagewall	354-357
Bicycle Storage Rack	416
Bins	417-419

Boardroom Tables

Alpine	308-309
Barrel Top	327,328,329,342
Circular	308,310,325,326,329
Colorado	325,327,328,329
Flip-top	325,343
Nova	310-312
Oval	309,328,329
Pole Leg Tables	326,346

Bookcases

Alpine X Storage Range	314-317
Bookshelves	58,61,78,110
Classtore Modular	98-99
Coloured Edge	61
Desk High	331,333
Orbit Range	339
Quadrant	331
Signature	340-341
Book Storage	108,110,111
Break Out Seating	199,247,248-249
Built In Classroom Storage	95-99

C

Cable Management	312,350-352
Cafeteria Tables	184-185

Calstor

Art Storage	85
Classroom Trolleys	89
Flexible Storage	88
Library Storage	89
Cantilever Shelving	193

Carpets

Design & Refurbishment	438-439
Early Years	121-123

Chairs

Anti Tilt	38,40-41,44
Atlas	178
Bordeaux	263



Cantilever	35,37
Cathedral Chair	272
Chair Trolley	32,43,274,275
Chevron Posture	40
Chiltern	31
Classic Poly	32
Classroom	30-43
Dining	176-183
Eaton	155
Ergo	41
Ermmington	183
Event	43
Flow	37,177
Folding	43
Forum	34
Freeway	176
Gorgio	262
High chairs	46,47

IT Chairs	152-158
La Rocca	177
Merlin	253
Metallique	182
Mono Posture	38,39
Opto	36
Oslo	276
Pennine Plus	42
Planet	31
Polka	177
Poly	32
Poly Superior	33
Posture	38-42
Recycled	31
Roma	39
Seville	181
Skagen	183
Skidbase	30,34,37,39,176,178
Spar	182
Stacking	38-41,176,177,180,181
Standfast	33
Stanza	181
Strata	182



Tamperproof	33,152,156
The Profile	35
Tuscany	176
Veneto	181
Vogue	272
Classroom Storage	
Colorstore Units	79-83

Metal Tray Units	85,86,88-94
Tray Units	54-57,60,62-75, 80-84,86,88,90-94
White Range	72-73
Classtore Modular Storage	98-99
Cloakroom & Washroom	
Benching	136-137
Coat & Bag Racks	138-139
Early Years	138-139
Lockers	140-147
Cloakroom Trolleys	87
Coat Hooks & Rails	139
Coffee Tables	116,222,223,226,231
Alpine	251
Metal Frame	250,251
Wooden	250,251
Computer Accessories	159-163,350-353
Conference Seating	266-277
Conference Tables	
Alpine	307-309
Colorado	325-329
Galway	346
Nova	310-311
Orbit	342-343
Wexford	346
Coloured Edge Storage	
Bookcase & Cupboards	61
Tray Units	60
Coloured Filing Cabinet	359
COSSH Cupboards	364
Creative! Early Years Range	
Art Storage	114
Baby Changing Units	114
Bookcases	110
Dens	115
Kitchen Units	106
Role Play Panels	104-105
Storage Units	107-112
Tables & Chairs	113
Tray Units	111-112
Cupboards	
Alpine X Storage Range	314-317
Classroom	54-66,69,70-71,74,77,80-83
Coloured Edge Storage	61
Colourstore	80-83
COSSH	364
Desk High	332,333,339
Open Bookcases	58,61,333,339
Orbit	339
Premium Range	70-71
Pigeon Hole	347

Signature Storage	340-341
Sliding Door Tray Units	65
Steel Storage	360-365,369
Storage Wall	354-357
Tambour Cupboard	314,316,317, 332,340-341,361
Wooden Cupboards	59,61,69,74,77
Cushions	117,118,120
Cycle Racks	419
Cycle Lockers	416
Cycle Shelters	420

D

Data Leads	351
Data & Power Modules	350,351
Design & Refurb	422-443

Desks

Alpine	304-306
Bench Desking	311
Cantilever Leg	306
Colorado	318-324
Exam	48-49
Height Adjustable	24,344-345
Locker	25
Orbit	338
Panel Leg	304
Reception	288-289



Teacher	26,27
Trolley	48
Wooden	25-27
Dining Furniture	
Benches	186-187

Bench Tables	167-169,186-187
Chairs	176-183
Fixed Seat Solutions	167-169
Folding Tables	166,167-169
Fresco	175
Outdoor	175,181
Screens	187
Stools	176,178
Tables	167-169,172-175
Tilt Top	166
Trolley	174
Wall Pocket System	170-171

Display Panels

Folding	392-395
Heavy Duty	393
Interactive	381
Lightweight	392
Mobile Room Dividers	395
Panel Bags	392
Pole and Panel	394
Tabletop	392-393
Dormitories	334-337
DuraStore Lockers	144-145

E

Early Years

Activity Rugs	121-123
Art Storage	75,114,128
Bean Bags	117,118
Book Storage	108,109,110
Bookcases	58,61,75,110
Carpets	121-123
Cloakroom	138-139
Cloakroom Trolleys	87
Creative! Range	102-115
Cushions	117,118,120
Height Adjustable Tables	131,132
Kinderbox Units	75
Mats	120-123
Nursery Chairs	113,130
Nursery Tables	113,130,132
Outdoor Learning	133
Paper Storage	85
Room Scene Kits	126
Role Play Panels	104-105
Rugs	121-123
Sand & Water Play	124
Sofas	116
Soft Seating	116-119
Stacking Storage	68-69

Storage Solutions	75,81,87
Themed Cushions	117
Themed Nursery Seating	117
Themed Rugs	121-123
Tray Storage	111-112
Trolleys	120,129
Easels	114,125,128,378-379
Easi-Fold Staging	211
Exam Desks	48-49
Executive Seating	262-263,278-279

F

Fabric Swatches	284-287
-----------------	---------

Filing Cabinets

Double Secure	369
Steel	358-359
Fire Resistant	369
Signature	340
Wooden	314,331

Filing Cupboards

Alpine X-Range	314-317
Double Secure	369
Colorado	332
Fire Resistant	369
Orbit	339
Signature	340-341
Steel	360-363,369
Flipchart Easels	378-379
Flip Top Desks	166
Floor Cushions	117,118,120
Folding Chairs	43

Folding Tables

Boardroom	307,325,343
Dining	166-174
Exam	48-49
Meeting	307,325
Training	307,325,343

G

Glass Magnetic Whiteboard	375
Glass Showcases	398,399
Gratnell's Trays	52
Gratnell's Tray Storage Units	54-57,60, 62-75,80-84,88,90-94
Grit Bin	417

H

HandiStor Storage	90
-------------------	----

Height Adjustable Tables

Early Years	131,132
Classroom	24
Office	344,345
Hushboard Acoustic Tiles	402-407

I

Interactive Display Boards	381
----------------------------	-----

IT Desking & Benching

Design & Fit-out	430
IT Desks	150-151
Laptop Unit	159
Nova Bench Desking	311
Workstations	150-151

IT Seating

Eaton	155
Flow IT Chair	152
IT Stool	157
IT Tamperproof	156
Mobile+ Chair	158
Mono Posture	154
Pennine	154
Positive Posture IT Chair	153
Profile Chair	152
Ruckus	158
Student Tamperproof	156
Vogue IT	153
IT Storage, Lapcabby	162-163
IT Suites	148-163

K

Kinderbox Units	75,84,197
KomfiTub Children's Seating	116

L

Laptop Storage	162-163
Lecterns	400

Leather Chairs

Conference	278-279
Managers	262-263
Reception Seating	228,233,235
Tub	228

Library Furniture

Cantilever Shelving	193
Coniston Shelving	194
Dynamix Library Shelving	192
Grasmere Curved Storage	194
Kandi	198
Lundy Library Units	195
Library Seating	199-203
Light-Build Staging	208-209
Literature Display	396

Lockers

Cube	141
Dangerous Substance	364
Janitorial	141
Laptop Charging	159-161
Mylockers	146-147
Outdoor	416
Plastic	144-145
Steel	140-141,142-143

M

Magnetic Boards	125,372,374,377
Mats	121-123
Meeting Tables	307-311, 325-329,342-343,346
Mesh Back Chairs	257,268,271,277
Metal Cupboards	360-365,369
Metal Pedestals	366
Metal Tray Storage	85,86,88-94
Modular Seating	116,199,200-203, 220-223,236-239,241
Monitor Arms	352
Multi Drawer Cabinets	358
Multiwall	95

N**Noticeboards**

Aluminium Frame Cork	383
Aluminium Frame Felt	383
Exterior	390-391
Felt Boards	382-384
Fire Retardant	82,383,384, 385,388,389
Tamperproof Lockable	358,386
Unframed	382
Nursery Chairs	113,130
Nursery Furniture	107-119,128-132
Nursery Tables	113,130,132

O

Office Chairs 252-279

Office Desking

Alpine 304-306
 Colorado 318-324
 Executive Desking 322-324
 Nova Desking 311
 Orbit Panel Leg Desking 338

Orbit Furniture Range

Desking 338,344
 Meeting Tables 342-343
 Storage 339

Operator Chairs

Operator Chairs 252-257

Outdoor Furniture

Bins 417-419
 Canopies 420-421
 Cotswold Concrete &
 Wood Range 413
 Cycle Racks 419
 Grit Bin 417
 Lockers 416
 Outdoor Seating 181,410-415
 Picnic Benches 410-411,413,415
 Recycled Benches 412
 Shelters/Canopies 420-421
 Wooden Benches 410-413

P

Paper Storage 85

Pedestals

Metal 366
 Wooden 313,330,332,338

Picnic Benches

Stone Effect 415
 Wooden 410-411,413

Pigeon Hole Units

Storage Wall 354-357

Plan Chests

Plants 301

Plastic Storage Trays

Poster Frames 397

Power Modules

Premium Storage Range 70-71

Presentation & Display

Display Cases 398-399
 Display Panels 392-395
 Flipchart Easels 378-379
 Hushboard 402-407

Interactive Display Boards 381
 Mobile Room Dividers 395
 Noticeboards 382-391
 Whiteboards 372-377
 Projection Screens 380

**R**

Rapid-Build Staging 212-214
 Reception Furniture 288-301
 Reception Seating 220-249
 Recycled Chairs 31
 Refurbishment 422-443
 Retreat Booths 200,204,205,244-247

S**Safes**

Electronic Safe 367,368
 Fire Resistant Media Safe 369
 Sand & Water Play 124,133

Seating

Backcare Chairs 264-265
 Café Seating 176-183
 Conference Seating 266-279
 Early Years Seating 113,116-119,130
 Fabric Swatches 284-287
 High Back Sofas 239,240
 Library Seating
 Managers/Executive Chairs 262-263,
 278-279
 Meeting/Conference Chairs 266-277
 Mesh Back 257,268,271,277
 Modular Seating 116,199,200-203,
 220-223,236-239,241
 Operator Seating 252-257

Pouffes 117,118,119
 Reception Seating 220-249
 Reception Steel Frame 224-226,2
 30-232
 Seating Dimensions 280-283
 Seating Index 218-219
 Staffroom Seating 220-248
 Sofas 220-223,228-229,233-235
 Task Chairs 258-261
 Tubs 228-229

Secure Storage

Cupboards 369
 Fire Resistant Safe 368
 Safes 367-368

Screens

Desk Mounted 300,312,348-349
 Dining 187
 Floor Standing 348

Showcases

External 390-391
 Fire Resistant 389
 Glass Display Cases 386,387,388,
 389,398-399
 Interior 386,387
 Side Opening Tambours 332
 Sink Unit 99
 Sofas 220-223,228-229,233-235
 Soft Seating 116-119,220-249
 Staging & Auditorium 206-215
 Staffroom Seating 220-248

Steel Storage

Dangerous Substances 365
 Filing Cabinets 358,359
 Lockers 140-147
 Multidrawer Units 358
 Pedestals 366
 Safes 367-368
 Storage Cupboards 360-365
 Tambour Cupboard 361
 TecniStor Tray Storage 92-94
 STEM Trolley 91

Stools

Active Balance 36
 Dining 178
 Graduate Cantilever 44
 IT 157
 Mono Posture 47
 Olympic 44
 Rectangular 46
 Skid Base 44,45,46,47
 Stacking 44-46

Student Lipped	45
Wooden	45

Storage

Alpine Office Storage	313-314
Bag Storage	79
Calstor Art Storage	85
Calstor Classroom Trolleys	88-89
Calstor Flexible Storage	88
Calstor Library Storage	89
Candy Colours Units	75-77
Charging Lockers	159,160
Classtor Modular Storage	98-99
Colorstore	79-83,84
Coloured Edge Storage	60-61
Early Years Storage	75-77,107-112,128-129
Fire Resistant Filing Cabinets	369
Grasmere Book Storage	194
Gratnell's Tray	52
HandiStor	90
Kinderbox	75,84,197
Lapcabby	162-163
Laptop Charging Locker	159
Locking Secure Filing Cabinets	369
Metal Storage	358-369
Multidrawer	358
Orbit	339
Paper Storage Unit	85
Pedestals	313,330,332,338,366
Pigeon Hole Units	347
Premium Range	70-71
Safes	367-368
Signature	340-341
Sports Trolley	86
Steel Storage	358-369
Storage Cupboards	315-317,332-333,339-341,360-365



Storage Trays	52
Storage Trolleys	86,91
Storagewall	354-357
Tambour Cupboards	314,316,317,331,332,341,361
TecniStor	92-94
Tray Storage Units	54-57,60,62-75,

Wooden Filing Cabinets	80-85,88-94,111-112
314,331	

Storage Trolley

Cloakroom Trolley	87,89
Exam Chair Trolley	43
Exam Desk Trolley	48
Lunchbox Trolley	87
Sports Trolley	86
Transporting	86
Story Cushions	120

T**Tables**

Cantilever	11
Classroom	8-21
Clover	9
Conference Tables	307-309,310-311,325-326,342-343,346
Coffee Tables	116,222,223,226,231,250-251
Craft	22
Creative Cluster	8-9
Crushbent	16-17,18
Diamond	8
Exam	48-49
Fast - Track	11
Fully Welded	14-15,19-21
Heavy Duty	10
Height Adjustable Tables	24,131,132,344,345
Meeting	307-311,325-329,342-343,346
Nursery	113,130,132
Outdoor	181,410-411,413,415
Premium	13
Primary	12
Project	23
Stacking	16-18
Table Height Guidance	6
Tilt Top	166,307,325,343
Tray	20
Tambour Cupboards	314,316,317,331,332,341,361
Task Chairs	258-261
Teacher Cupboards	363
Teaching Wall	96-97
TecniStor Storage	92-94
Transporting Trolley	86
Tray Storage Units	54-57,60,62-75,80-85,88-94,111-112
Tray Tables	20

Trolley

Chair Trolley	32,34,39,40,43
Cloakroom Trolley	87,89
Computer Trolley	159
Exam Desk Trolley	48
Lunchbox Trolley	87
Sports Trolley	86
STEM Trolley	91
Transporting	86

Tilt Top Tables

Dining	166
Tilt-Top	307,325,343

W**Wall Storage**

Multiwall	95
Teaching Wall	96-97

Washrooms

Accessories	426-427
Coat & Bag Racks	79,138-139,146-147

Whiteboards

Coloured Edge	373
Gridded Boards	372
Mobile Whiteboards	375,376,377
Magnetic Glass	375
Non-Magnetic	372,373,374,376,377
Revolving Whiteboards	376,377
Table Tops	13
Workstation	159
Work Benches	23

Prices and product availability may vary during the lifetime of this catalogue. Please contact us to confirm at time of order.

©2021 E&OE

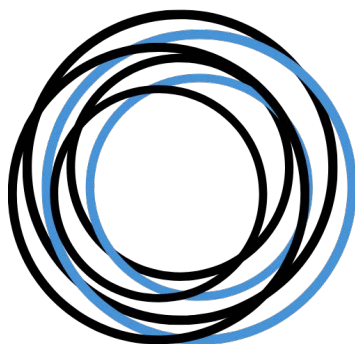

SPACES TAYLORED



Spaces Taylored

+44 (0)843 122 9545

info@spacestaylored.com

www.spacestaylored.com